

## 目錄 Contents

002 小型材系列

035 大型材系列

052 側發光系列

055 垂直角應用

059 浴廁空間應用

063 踢腳板空間

065 間照系列

069 板材應同

071 吊衣桿應用

072 階梯照明

073 環形照明方案

080 弧線照明方案

088 線性照明方案

141 天際線 線性照明

160 無光斑燈帶方案

166 超長距燈條方案

170 特殊調光調色燈條方案

181 LED 光膜照明方案

186 軌道式照明

191 戶外照明燈具

## SL0510

- 可應用於各種狹小空間
- 零光斑 · 出光均勻柔和
- 高品質表面處理 · 高品質PC擴散面罩
- 型材、面罩長度一致 · 一刀完成切割

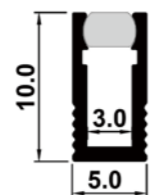

### ◆ 基本參數 BASIC PARAMETERS

|      |           |
|------|-----------|
| 鋁材質  | AL6063-T5 |
| 表面工藝 | 氧化亞銀處理    |
| 面罩材質 | 白色無光點PC罩  |
| 色號   | RAL9003   |

### ◆ 標準配備 STANDARD ACCESSORIES

#### 型材組件 Profile Components

|      |                |  |
|------|----------------|--|
| 型材   | L2000*W5*H10mm |  |
| 面罩   |                |  |
| 堵頭*2 |                |  |

### ◆ 選購配備 OPTIONAL ACCESSORIES

#### 安裝配件 Installation Accessories



#### 光源配件 Lighting Source

適用 2835 120燈/米 12w/ 3000K / 4000K / 6000K / 5mm / CRI>90

## SL0809A

- 適用狹小空間 ·
- 零光斑 · 出光均勻柔和
- 高品質PC擴散面罩
- 型材、面罩長度一致 · 一刀完成切割

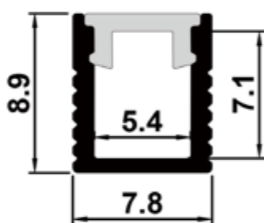

### ◆ 基本參數 BASIC PARAMETERS

|      |           |
|------|-----------|
| 鋁材質  | AL6063-T5 |
| 表面工藝 | 氧化亞銀處理    |
| 面罩材質 | 白色無光點PC罩  |
| 色號   | RAL9003   |

### ◆ 標準配備 STANDARD ACCESSORIES

#### 型材組件 Profile Components

|       |                   |  |
|-------|-------------------|--|
| 型材    | L2000*W7.8*H7.1mm |  |
| 面罩    |                   |  |
| 堵頭 *2 |                   |  |

### ◆ 選購配備 OPTIONAL ACCESSORIES

#### 安裝配件 Installation Accessories



#### 光源配件 Lighting Source

適用 2835 120燈/米 12w/ 3000K / 4000K / 6000K / 5mm / CRI>90

## SL0812

- 適用狹小空間 ·
- 零光斑 · 出光均勻柔和
- 高品質PC擴散面罩
- 型材、面罩長度一致 · 一刀完成切割

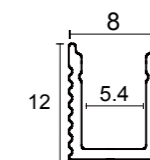

### ◆ 基本參數 BASIC PARAMETERS

|      |           |
|------|-----------|
| 鋁材質  | AL6063-T5 |
| 表面工藝 | 氧化亞銀處理    |
| 面罩材質 | 白色無光點PC罩  |
| 色號   | RAL9003   |

### ◆ 標準配備 STANDARD ACCESSORIES

#### 型材組件 Profile Components

|      |                 |  |
|------|-----------------|--|
| 型材   | L3000*W8*H112mm |  |
| 面罩   |                 |  |
| 堵頭*2 |                 |  |

### ◆ 選購配備 OPTIONAL ACCESSORIES

#### 安裝配件 Installation Accessories

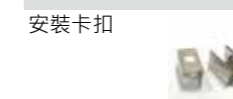

#### 光源配件 Lighting Source

適用 2835 120燈/米 12w/ 3000K / 4000K / 6000K / 5mm / CRI>90

## SL0809B

- 適用狹小空間 ·
- 零光斑 · 出光均勻柔和
- 高品質PC擴散面罩
- 型材、面罩長度一致 · 一刀完成切割

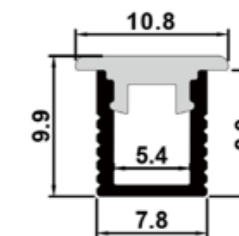

### ◆ 基本參數 BASIC PARAMETERS

|      |           |
|------|-----------|
| 鋁材質  | AL6063-T5 |
| 表面工藝 | 氧化亞銀處理    |
| 面罩材質 | 白色無光點PC罩  |
| 色號   | RAL9003   |

### ◆ 標準配備 STANDARD ACCESSORIES

#### 型材組件 Profile Components

|       |                   |  |
|-------|-------------------|--|
| 型材    | L2000*W7.8*H8.9mm |  |
| 面罩    |                   |  |
| 堵頭 *2 |                   |  |

### ◆ 選購配備 OPTIONAL ACCESSORIES

#### 安裝配件 Installation Accessories

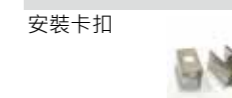

#### 光源配件 Lighting Source

適用 2835 120燈/米 12w/ 3000K / 4000K / 6000K / 5mm / CRI>90

## SL1010A

- 適用狹小空間 ·
- 零光斑 · 出光均勻柔和
- 高品質PC擴散面罩
- 型材、面罩長度一致 · 一刀完成切割



### 基本參數 BASIC PARAMETERS

|      |           |
|------|-----------|
| 鋁材質  | AL6063-T5 |
| 表面工藝 | 陽極氧化      |
| 面罩材質 | 白色無光點PC罩  |
| 色號   | RAL9003   |

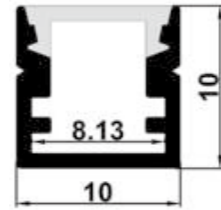

### 標準配備 STANDARD ACCESSORIES

#### 型材組件 Profile Components

型材 L3000\*W10\*H10mm

面罩

堵頭 \*2



### 選購配備 OPTIONAL ACCESSORIES

#### 安裝配件 Installation Accessories

安裝卡扣



#### 光源配件 Lighting Source

適用 2835 120燈/米 12w/ 3000K / 4000K / 6000K / 5mm / CRI>90



## SL1010B

- 適用狹小空間 ·
- 零光斑 · 出光均勻柔和
- 高品質PC擴散面罩
- 型材、面罩長度一致 · 一刀完成切割



### 基本參數 BASIC PARAMETERS

|      |           |
|------|-----------|
| 鋁材質  | AL6063-T5 |
| 表面工藝 | 陽極氧化      |
| 面罩材質 | 白色無光點PC罩  |
| 色號   | RAL9003   |

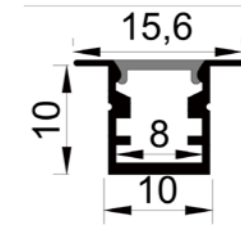

### 標準配備 STANDARD ACCESSORIES

#### 型材組件 Profile Components

型材 L3000\*W10\*H10mm

面罩

堵頭 \*2



### 選購配備 OPTIONAL ACCESSORIES

#### 安裝配件 Installation Accessories

安裝卡扣



#### 光源配件 Lighting Source

適用 2835 120燈/米 12w/ 3000K / 4000K / 6000K / 5mm / CRI>90

## SL1013A

- 適用狹小空間 ·
- 零光斑 · 出光均勻柔和
- 高品質PC擴散面罩
- 型材、面罩長度一致 · 一刀完成切割



### 基本參數 BASIC PARAMETERS

|      |           |
|------|-----------|
| 鋁材質  | AL6063-T5 |
| 表面工藝 | 陽極氧化      |
| 面罩材質 | 白色無光點PC罩  |
| 色號   | RAL9003   |

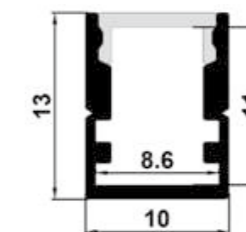

### 標準配備 STANDARD ACCESSORIES

#### 型材組件 Profile Components

型材 L3000\*W10\*H13mm

面罩

堵頭 \*2



### 選購配備 OPTIONAL ACCESSORIES

#### 安裝配件 Installation Accessories

安裝卡扣



#### 光源配件 Lighting Source

適用 2835 120燈/米 12w/ 3000K / 4000K / 6000K / 5mm / CRI>90

## SL1013B

- 適用狹小空間 ·
- 零光斑 · 出光均勻柔和
- 高品質PC擴散面罩
- 型材、面罩長度一致 · 一刀完成切割

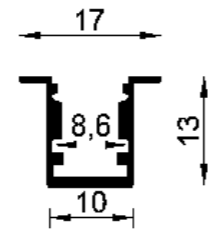

### ◆ 基本參數 BASIC PARAMETERS

|      |           |
|------|-----------|
| 鋁材質  | AL6063-T5 |
| 表面工藝 | 陽極氧化      |
| 面罩材質 | 白色無光點PC罩  |
| 色號   | RAL9003   |

### ◆ 標準配備 STANDARD ACCESSORIES

#### 型材組件 Profile Components

|    |                 |
|----|-----------------|
| 型材 | L3000*W10*H13mm |
|----|-----------------|



#### 面罩

堵頭 \*2

### ◆ 選購配備 OPTIONAL ACCESSORIES

#### 安裝配件 Installation Accessories

安裝卡扣



#### 光源配件 Lighting Source

適用 2835 120燈/米 12w/ 3000K / 4000K / 6000K / 5mm / CRI>90



## SL1015A

- 適用狹小空間 ·
- 零光斑 · 出光均勻柔和
- 高品質PC擴散面罩
- 型材、面罩長度一致 · 一刀完成切割

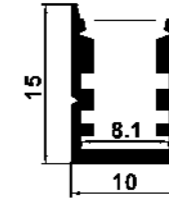

### ◆ 基本參數 BASIC PARAMETERS

|      |           |
|------|-----------|
| 鋁材質  | AL6063-T5 |
| 表面工藝 | 陽極氧化      |
| 面罩材質 | 白色無光點PC罩  |
| 色號   | RAL9003   |

### ◆ 標準配備 STANDARD ACCESSORIES

#### 型材組件 Profile Components

|    |                 |
|----|-----------------|
| 型材 | L3000*W10*H13mm |
|----|-----------------|



#### 面罩

堵頭 \*2

### ◆ 選購配備 OPTIONAL ACCESSORIES

#### 安裝配件 Installation Accessories

安裝卡扣



#### 光源配件 Lighting Source

適用 2835 120燈/米 12w/ 3000K / 4000K / 6000K / 5mm / CRI>90

## SL1015B

- 適用狹小空間 ·
- 零光斑 · 出光均勻柔和
- 高品質PC擴散面罩
- 型材、面罩長度一致 · 一刀完成切割

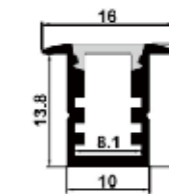

### ◆ 基本參數 BASIC PARAMETERS

|      |           |
|------|-----------|
| 鋁材質  | AL6063-T5 |
| 表面工藝 | 陽極氧化      |
| 面罩材質 | 白色無光點PC罩  |
| 色號   | RAL9003   |

### ◆ 標準配備 STANDARD ACCESSORIES

#### 型材組件 Profile Components

|    |                 |
|----|-----------------|
| 型材 | L3000*W10*H13mm |
|----|-----------------|



#### 面罩

堵頭 \*2

### ◆ 選購配備 OPTIONAL ACCESSORIES

#### 安裝配件 Installation Accessories

安裝卡扣



#### 光源配件 Lighting Source

適用 2835 120燈/米 12w/ 3000K / 4000K / 6000K / 5mm / CRI>90

## SL1212A

- 適用狹小空間 ·
- 零光斑 · 出光均勻柔和
- 高品質PC擴散面罩
- 型材、面罩長度一致 · 一刀完成切割

### ◆ 基本參數 BASIC PARAMETERS

|      |           |
|------|-----------|
| 鋁材質  | AL6063-T5 |
| 表面工藝 | 陽極氧化      |
| 面罩材質 | 白色無光點PC罩  |
| 色號   | RAL9003   |

### ◆ 標準配備 STANDARD ACCESSORIES

#### 型材組件 Profile Components

|       |                 |   |
|-------|-----------------|---|
| 型材    | L3000*W12*H12mm |  |
| 面罩    |                 |   |
| 堵頭 *2 |                 |   |

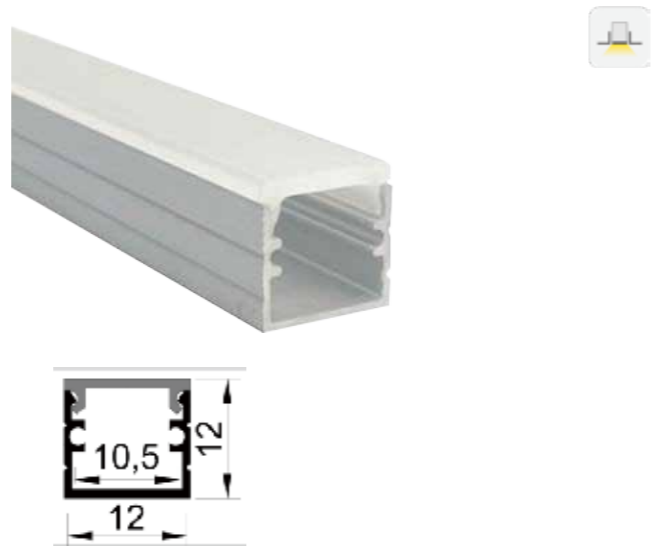

### ◆ 選購配備 OPTIONAL ACCESSORIES

#### 安裝配件 Installation Accessories



#### 光源配件 Lighting Source

適用 2835 120燈/米 12w/ 3000K / 4000K / 6000K / 5mm / CRI>90

## SL1212B

- 適用狹小空間 ·
- 零光斑 · 出光均勻柔和
- 高品質PC擴散面罩
- 型材、面罩長度一致 · 一刀完成切割

### ◆ 基本參數 BASIC PARAMETERS

|      |           |
|------|-----------|
| 鋁材質  | AL6063-T5 |
| 表面工藝 | 陽極氧化      |
| 面罩材質 | 白色無光點PC罩  |
| 色號   | RAL9003   |

### ◆ 標準配備 STANDARD ACCESSORIES

#### 型材組件 Profile Components

|       |                     |   |
|-------|---------------------|---|
| 型材    | L3000*W12.6*H11.6mm |  |
| 面罩    |                     |   |
| 堵頭 *2 |                     |   |



### ◆ 選購配備 OPTIONAL ACCESSORIES

#### 安裝配件 Installation Accessories



#### 光源配件 Lighting Source

適用 2835 120燈/米 12w/ 3000K / 4000K / 6000K / 5mm / CRI>90

## SL1207

- 可應用於各種狹小空間
- 零光斑 · 出光均勻柔和
- 高品質表面處理 · 高品質PC擴散面罩
- 型材、面罩長度一致 · 一刀完成切割

### ◆ 基本參數 BASIC PARAMETERS

|      |           |
|------|-----------|
| 鋁材質  | AL6063-T5 |
| 表面工藝 | 氧化亞銀處理    |
| 面罩材質 | 白色無光點PC罩  |
| 色號   | RAL9003   |

### ◆ 標準配備 STANDARD ACCESSORIES

#### 型材組件 Profile Components

|      |                |   |
|------|----------------|---|
| 型材   | L3000*W12*H7mm |  |
| 面罩   |                |  |
| 堵頭*2 |                |  |

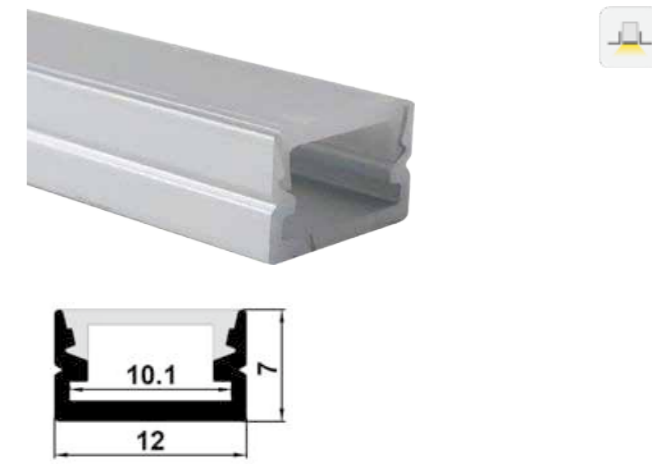

### ◆ 選購配備 OPTIONAL ACCESSORIES

#### 安裝配件 Installation Accessories

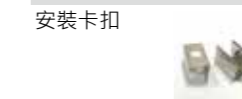

#### 光源配件 Lighting Source

適用 2835 120燈/米 12w/ 3000K / 4000K / 6000K / 5mm / CRI>90  
適用 2835 182燈/米 15w/ 3000K / 4000K / 6000K / 10mm / CRI>90

## SL1215A

- 可應用於各種狹小空間
- 零光斑 · 出光均勻柔和
- 高品質表面處理 · 高品質PC擴散面罩
- 型材、面罩長度一致 · 一刀完成切割

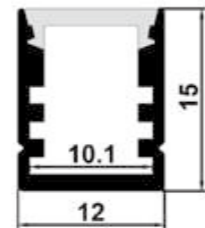

### ◆ 基本參數 BASIC PARAMETERS

|      |           |
|------|-----------|
| 鋁材質  | AL6063-T5 |
| 表面工藝 | 氧化亞銀處理    |
| 面罩材質 | 白色無光點PC罩  |
| 色號   | RAL9003   |

### ◆ 標準配備 STANDARD ACCESSORIES

#### 型材組件 Profile Components

|      |                |   |
|------|----------------|---|
| 型材   | L3000*W12*H7mm |  |
| 面罩   |                |  |
| 堵頭*2 |                |  |

### ◆ 選購配備 OPTIONAL ACCESSORIES

#### 安裝配件 Installation Accessories



#### 光源配件 Lighting Source

適用 2835 120燈/米 12w/ 3000K / 4000K / 6000K / 5mm / CRI>90  
 適用 2835 182燈/米 15w/ 3000K / 4000K / 6000K / 10mm / CRI>90

## SL1215B

- 可應用於各種狹小空間
- 零光斑 · 出光均勻柔和
- 高品質表面處理 · 高品質PC擴散面罩
- 型材、面罩長度一致 · 一刀完成切割

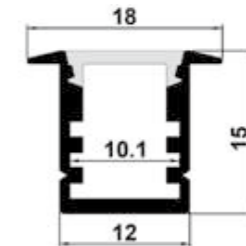



### ◆ 基本參數 BASIC PARAMETERS

|      |           |
|------|-----------|
| 鋁材質  | AL6063-T5 |
| 表面工藝 | 氧化亞銀處理    |
| 面罩材質 | 白色無光點PC罩  |
| 色號   | RAL9003   |

### ◆ 標準配備 STANDARD ACCESSORIES

#### 型材組件 Profile Components

|      |                |   |
|------|----------------|---|
| 型材   | L3000*W14*H7mm |  |
| 面罩   |                |  |
| 堵頭*2 |                |  |

### ◆ 選購配備 OPTIONAL ACCESSORIES

#### 安裝配件 Installation Accessories



#### 光源配件 Lighting Source

適用 2835 120燈/米 12w/ 3000K / 4000K / 6000K / 5mm / CRI>90  
 適用 2835 182燈/米 15w/ 3000K / 4000K / 6000K / 10mm / CRI>90

## SL1515

- 可應用於各種狹小空間
- 零光斑 · 出光均勻柔和
- 高品質表面處理 · 高品質PC擴散面罩
- 型材、面罩長度一致 · 一刀完成切割

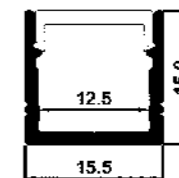



### ◆ 基本參數 BASIC PARAMETERS

|      |           |
|------|-----------|
| 鋁材質  | AL6063-T5 |
| 表面工藝 | 氧化亞銀處理    |
| 面罩材質 | 白色無光點PC罩  |
| 色號   | RAL9003   |

### ◆ 標準配備 STANDARD ACCESSORIES

#### 型材組件 Profile Components

|      |                 |   |
|------|-----------------|---|
| 型材   | L3000*W15*H15mm |  |
| 面罩   |                 |  |
| 堵頭*2 |                 |  |

### ◆ 選購配備 OPTIONAL ACCESSORIES

#### 安裝配件 Installation Accessories



#### 光源配件 Lighting Source

## SL1415A



- 可應用於各種狹小空間
- 零光斑 · 出光均勻柔和
- 高品質表面處理 · 高品質PC擴散面罩
- 型材、面罩長度一致 · 一刀完成切割

### ◆ 基本參數 BASIC PARAMETERS

|      |           |
|------|-----------|
| 鋁材質  | AL6063-T5 |
| 表面工藝 | 氧化亞銀處理    |
| 面罩材質 | 白色無光點PC罩  |
| 色號   | RAL9003   |

### ◆ 標準配備 STANDARD ACCESSORIES

#### 型材組件 Profile Components

|      |                 |   |
|------|-----------------|---|
| 型材   | L3000*W14*H15mm |  |
| 面罩   |                 |  |
| 堵頭*2 |                 |  |

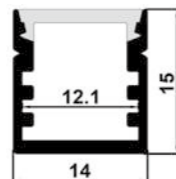

### ◆ 選購配備 OPTIONAL ACCESSORIES

#### 安裝配件 Installation Accessories



#### 光源配件 Lighting Source

適用 2835 120燈/米 12w/ 3000K / 4000K / 6000K / 5mm / CRI>90  
 適用 2835 182燈/米 15w/ 3000K / 4000K / 6000K / 10mm / CRI>90

## SL1407



- 可應用於各種狹小空間
- 零光斑 · 出光均勻柔和
- 高品質表面處理 · 高品質PC擴散面罩
- 型材、面罩長度一致 · 一刀完成切割

### ◆ 基本參數 BASIC PARAMETERS

|      |           |
|------|-----------|
| 鋁材質  | AL6063-T5 |
| 表面工藝 | 氧化亞銀處理    |
| 面罩材質 | 白色無光點PC罩  |
| 色號   | RAL9003   |

### ◆ 標準配備 STANDARD ACCESSORIES

#### 型材組件 Profile Components

|      |                |   |
|------|----------------|---|
| 型材   | L3000*W14*H7mm |  |
| 面罩   |                |  |
| 堵頭*2 |                |  |



### ◆ 選購配備 OPTIONAL ACCESSORIES

#### 安裝配件 Installation Accessories

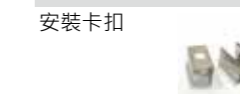

#### 光源配件 Lighting Source

## SL1415B



- 可應用於各種狹小空間
- 零光斑 · 出光均勻柔和
- 高品質表面處理 · 高品質PC擴散面罩
- 型材、面罩長度一致 · 一刀完成切割

### ◆ 基本參數 BASIC PARAMETERS

|      |           |
|------|-----------|
| 鋁材質  | AL6063-T5 |
| 表面工藝 | 氧化亞銀處理    |
| 面罩材質 | 白色無光點PC罩  |
| 色號   | RAL9003   |

### ◆ 標準配備 STANDARD ACCESSORIES

#### 型材組件 Profile Components

|      |                 |   |
|------|-----------------|---|
| 型材   | L3000*W14*H15mm |  |
| 面罩   |                 |  |
| 堵頭*2 |                 |  |

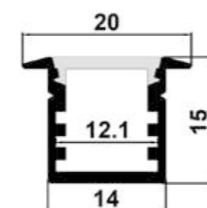

### ◆ 選購配備 OPTIONAL ACCESSORIES

#### 安裝配件 Installation Accessories



#### 光源配件 Lighting Source

適用 2835 120燈/米 12w/ 3000K / 4000K / 6000K / 5mm / CRI>90  
 適用 2835 182燈/米 15w/ 3000K / 4000K / 6000K / 10mm / CRI>90

## SL1506



- 可應用於狹小空間
- 零光斑 · 出光均勻柔和
- 高品質表面處理 · 高品質PC擴散面罩
- 型材、面罩長度一致 · 一刀完成切割

### ◆ 基本參數 BASIC PARAMETERS

|      |           |
|------|-----------|
| 鋁材質  | AL6063-T5 |
| 表面工藝 | 氧化亞銀處理    |
| 面罩材質 | 白色無光點PC罩  |
| 色號   | RAL9003   |

### ◆ 標準配備 STANDARD ACCESSORIES

#### 型材組件 Profile Components

|      |                    |   |
|------|--------------------|---|
| 型材   | L3000*W15.1*H6.7mm |  |
| 面罩   |                    |  |
| 堵頭*2 |                    |  |

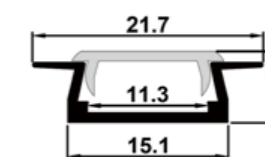

### ◆ 選購配備 OPTIONAL ACCESSORIES

#### 安裝配件 Installation Accessories

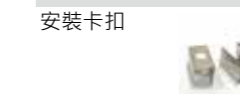

#### 光源配件 Lighting Source

適用 2835 120燈/米 12w/ 3000K / 4000K / 6000K / 5mm / CRI>90  
 適用 2835 182燈/米 15w/ 3000K / 4000K / 6000K / 10mm / CRI>90

## SL1609A

- 應用各種間照設計
- 零光斑 · 出光均勻柔和
- 高品質表面處理 · 高品質PC擴散面罩
- 型材、面罩長度一致 · 一刀完成切割

### ◆ 基本參數 BASIC PARAMETERS

|      |           |
|------|-----------|
| 鋁材質  | AL6063-T5 |
| 表面工藝 | 氧化亞銀處理    |
| 面罩材質 | 白色無光點PC罩  |
| 色號   | RAL9003   |

### ◆ 標準配備 STANDARD ACCESSORIES

#### 型材組件 Profile Components

|      |                  |   |
|------|------------------|---|
| 型材   | L3000*W16*H8.9mm |  |
| 面罩   |                  |  |
| 堵頭*2 |                  |  |

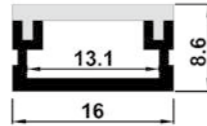

### ◆ 選購配備 OPTIONAL ACCESSORIES

#### 安裝配件 Installation Accessories



#### 光源配件 Lighting Source

## SL1609B



- 應用各種間照設計
- 零光斑 · 出光均勻柔和
- 高品質表面處理 · 高品質PC擴散面罩
- 型材、面罩長度一致 · 一刀完成切割

### ◆ 基本參數 BASIC PARAMETERS

|      |           |
|------|-----------|
| 鋁材質  | AL6063-T5 |
| 表面工藝 | 氧化亞銀處理    |
| 面罩材質 | 白色無光點PC罩  |
| 色號   | RAL9003   |

### ◆ 標準配備 STANDARD ACCESSORIES

#### 型材組件 Profile Components

|      |                  |   |
|------|------------------|---|
| 型材   | L3000*W16*H8.6mm |  |
| 面罩   |                  |  |
| 堵頭*2 |                  |  |

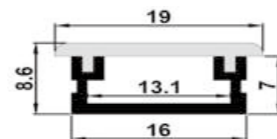

### ◆ 選購配備 OPTIONAL ACCESSORIES

#### 安裝配件 Installation Accessories



#### 光源配件 Lighting Source

## SL1525



- 應用各種間照設計
- 零光斑 · 出光均勻柔和
- 高品質表面處理 · 高品質PC擴散面罩
- 型材、面罩長度一致 · 一刀完成切割

### ◆ 基本參數 BASIC PARAMETERS

|      |           |
|------|-----------|
| 鋁材質  | AL6063-T5 |
| 表面工藝 | 氧化亞銀處理    |
| 面罩材質 | 白色無光點PC罩  |
| 色號   | RAL9003   |

### ◆ 標準配備 STANDARD ACCESSORIES

#### 型材組件 Profile Components

|      |                 |   |
|------|-----------------|---|
| 型材   | L3000*W15*H25mm |  |
| 面罩   |                 |  |
| 堵頭*2 |                 |  |

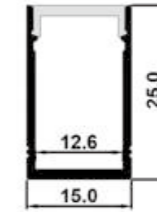

### ◆ 選購配備 OPTIONAL ACCESSORIES

#### 安裝配件 Installation Accessories

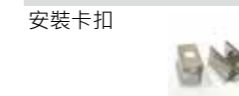

#### 光源配件 Lighting Source

適用 2835 120燈/米 12w/ 3000K / 4000K / 6000K / 5mm / CRI>90  
 適用 2835 182燈/米 15w/ 3000K / 4000K / 6000K / 10mm / CRI>90

## SL1607



- 應用各種間照設計
- 零光斑 · 出光均勻柔和
- 高品質表面處理 · 高品質PC擴散面罩
- 型材、面罩長度一致 · 一刀完成切割

### ◆ 基本參數 BASIC PARAMETERS

|      |           |
|------|-----------|
| 鋁材質  | AL6063-T5 |
| 表面工藝 | 氧化亞銀處理    |
| 面罩材質 | 白色無光點PC罩  |
| 色號   | RAL9003   |

### ◆ 標準配備 STANDARD ACCESSORIES

#### 型材組件 Profile Components

|      |                  |   |
|------|------------------|---|
| 型材   | L3000*W15.9*H7mm |  |
| 面罩   |                  |  |
| 堵頭*2 |                  |  |

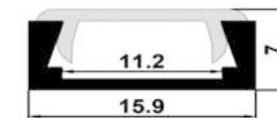

### ◆ 選購配備 OPTIONAL ACCESSORIES

#### 安裝配件 Installation Accessories

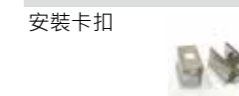

#### 光源配件 Lighting Source

適用 2835 120燈/米 12w/ 3000K / 4000K / 6000K / 5mm / CRI>90  
 適用 2835 182燈/米 15w/ 3000K / 4000K / 6000K / 10mm / CRI>90



## SL1612A



- 應用各種間照設計
- 零光斑 · 出光均勻柔和
- 高品質表面處理 · 高品質PC擴散面罩
- 型材、面罩長度一致 · 一刀完成切割

### ◆ 基本參數 BASIC PARAMETERS

|      |           |
|------|-----------|
| 鋁材質  | AL6063-T5 |
| 表面工藝 | 氧化亞銀處理    |
| 面罩材質 | 白色無光點PC罩  |
| 色號   | RAL9003   |

### ◆ 標準配備 STANDARD ACCESSORIES

#### 型材組件 Profile Components

|      |                   |   |
|------|-------------------|---|
| 型材   | L3000*W15.9*H12mm |  |
| 面罩   |                   |  |
| 堵頭*2 |                   |  |

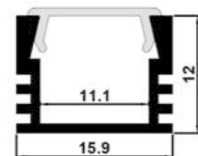

### ◆ 選購配備 OPTIONAL ACCESSORIES

#### 安裝配件 Installation Accessories



#### 光源配件 Lighting Source

適用 2835 120燈/米 12w/ 3000K / 4000K / 6000K / 5mm / CRI>90  
 適用 2835 182燈/米 15w/ 3000K / 4000K / 6000K / 10mm / CRI>90

## SL1612B



- 應用各種間照設計
- 零光斑 · 出光均勻柔和
- 高品質表面處理 · 高品質PC擴散面罩
- 型材、面罩長度一致 · 一刀完成切割

### ◆ 基本參數 BASIC PARAMETERS

|      |           |
|------|-----------|
| 鋁材質  | AL6063-T5 |
| 表面工藝 | 氧化亞銀處理    |
| 面罩材質 | 白色無光點PC罩  |
| 色號   | RAL9003   |

### ◆ 標準配備 STANDARD ACCESSORIES

#### 型材組件 Profile Components

|      |                   |   |
|------|-------------------|---|
| 型材   | L3000*W16*H11.7mm |  |
| 面罩   |                   |  |
| 堵頭*2 |                   |  |

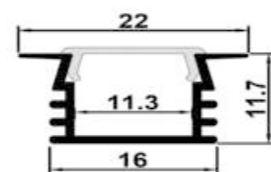

### ◆ 選購配備 OPTIONAL ACCESSORIES

#### 安裝配件 Installation Accessories



#### 光源配件 Lighting Source

適用 2835 120燈/米 12w/ 3000K / 4000K / 6000K / 5mm / CRI>90  
 適用 2835 182燈/米 15w/ 3000K / 4000K / 6000K / 10mm / CRI>90

## SL1613A



- 應用各種間照設計
- 零光斑 · 出光均勻柔和
- 高品質表面處理 · 高品質PC擴散面罩
- 型材、面罩長度一致 · 一刀完成切割

### ◆ 基本參數 BASIC PARAMETERS

|      |           |
|------|-----------|
| 鋁材質  | AL6063-T5 |
| 表面工藝 | 氧化亞銀處理    |
| 面罩材質 | 白色無光點PC罩  |
| 色號   | RAL9003   |

### ◆ 標準配備 STANDARD ACCESSORIES

#### 型材組件 Profile Components

|      |                   |   |
|------|-------------------|---|
| 型材   | L3000*W16*H12.6mm |  |
| 面罩   |                   |  |
| 堵頭*2 |                   |  |

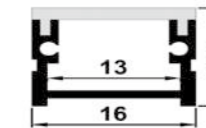

## SL1613B

- 應用各種間照設計
- 零光斑 · 出光均勻柔和
- 高品質表面處理 · 高品質PC擴散面罩
- 型材、面罩長度一致 · 一刀完成切割

### ◆ 基本參數 BASIC PARAMETERS

|      |           |
|------|-----------|
| 鋁材質  | AL6063-T5 |
| 表面工藝 | 氧化亞銀處理    |
| 面罩材質 | 白色無光點PC罩  |
| 色號   | RAL9003   |

### ◆ 標準配備 STANDARD ACCESSORIES

#### 型材組件 Profile Components

|      |                 |   |
|------|-----------------|---|
| 型材   | L3000*W16*H13mm |  |
| 面罩   |                 |  |
| 堵頭*2 |                 |  |

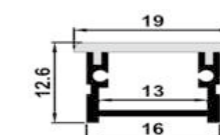

### ◆ 選購配備 OPTIONAL ACCESSORIES

#### 安裝配件 Installation Accessories



#### 光源配件 Lighting Source

適用 2835 120燈/米 12w/ 3000K / 4000K / 6000K / 5mm / CRI>90  
 適用 2835 182燈/米 15w/ 3000K / 4000K / 6000K / 10mm / CRI>90

### ◆ 選購配備 OPTIONAL ACCESSORIES

#### 安裝配件 Installation Accessories

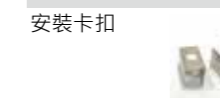

#### 光源配件 Lighting Source

適用 2835 120燈/米 12w/ 3000K / 4000K / 6000K / 5mm / CRI>90  
 適用 2835 182燈/米 15w/ 3000K / 4000K / 6000K / 10mm / CRI>90

## SL1707A

- 可應用於間照設計
- 零光斑 · 出光均勻柔和
- 高品質表面處理 · 高品質PC擴散面罩
- 型材、面罩長度一致 · 一刀完成切割

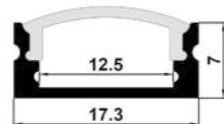

### ◆ 基本參數 BASIC PARAMETERS

|      |           |
|------|-----------|
| 鋁材質  | AL6063-T5 |
| 表面工藝 | 氧化亞銀處理    |
| 面罩材質 | 白色無光點PC罩  |
| 色號   | RAL9003   |

### ◆ 標準配備 STANDARD ACCESSORIES

#### 型材組件 Profile Components

|      |                  |  |
|------|------------------|--|
| 型材   | L3000*W17.3*H7mm |  |
| 面罩   |                  |  |
| 堵頭*2 |                  |  |

### ◆ 選購配備 OPTIONAL ACCESSORIES

#### 安裝配件 Installation Accessories



#### 光源配件 Lighting Source

適用 2835 120燈/米 12w/ 3000K / 4000K / 6000K / 5mm / CRI>90  
 適用 2835 182燈/米 15w/ 3000K / 4000K / 6000K / 10mm / CRI>90

## SL1714A

- 可應用於間照設計
- 零光斑 · 出光均勻柔和
- 高品質表面處理 · 高品質PC擴散面罩
- 型材、面罩長度一致 · 一刀完成切割

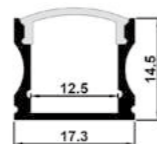

### ◆ 基本參數 BASIC PARAMETERS

|      |           |
|------|-----------|
| 鋁材質  | AL6063-T5 |
| 表面工藝 | 氧化亞銀處理    |
| 面罩材質 | 白色無光點PC罩  |
| 色號   | RAL9003   |

### ◆ 標準配備 STANDARD ACCESSORIES

#### 型材組件 Profile Components

|      |                     |  |
|------|---------------------|--|
| 型材   | L3000*W17.3*H14.5mm |  |
| 面罩   |                     |  |
| 堵頭*2 |                     |  |

### ◆ 選購配備 OPTIONAL ACCESSORIES

#### 安裝配件 Installation Accessories



#### 光源配件 Lighting Source

適用 2835 120燈/米 12w/ 3000K / 4000K / 6000K / 5mm / CRI>90  
 適用 2835 182燈/米 15w/ 3000K / 4000K / 6000K / 10mm / CRI>90

## SL1707B

- 可應用於間照設計
- 零光斑 · 出光均勻柔和
- 高品質表面處理 · 高品質PC擴散面罩
- 型材、面罩長度一致 · 一刀完成切割

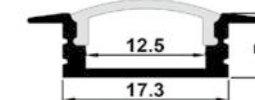

### ◆ 基本參數 BASIC PARAMETERS

|      |           |
|------|-----------|
| 鋁材質  | AL6063-T5 |
| 表面工藝 | 氧化亞銀處理    |
| 面罩材質 | 白色無光點PC罩  |
| 色號   | RAL9003   |

### ◆ 標準配備 STANDARD ACCESSORIES

#### 型材組件 Profile Components

|      |                  |  |
|------|------------------|--|
| 型材   | L3000*W17.3*H7mm |  |
| 面罩   |                  |  |
| 堵頭*2 |                  |  |

### ◆ 選購配備 OPTIONAL ACCESSORIES

#### 安裝配件 Installation Accessories

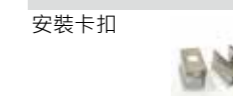

#### 光源配件 Lighting Source

適用 2835 120燈/米 12w/ 3000K / 4000K / 6000K / 5mm / CRI>90  
 適用 2835 182燈/米 15w/ 3000K / 4000K / 6000K / 10mm / CRI>90

## SL1714B

- 可應用於間照設計
- 零光斑 · 出光均勻柔和
- 高品質表面處理 · 高品質PC擴散面罩
- 型材、面罩長度一致 · 一刀完成切割

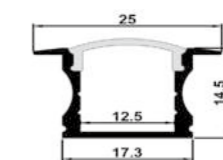

### ◆ 基本參數 BASIC PARAMETERS

|      |           |
|------|-----------|
| 鋁材質  | AL6063-T5 |
| 表面工藝 | 氧化亞銀處理    |
| 面罩材質 | 白色無光點PC罩  |
| 色號   | RAL9003   |

### ◆ 標準配備 STANDARD ACCESSORIES

#### 型材組件 Profile Components

|      |                     |  |
|------|---------------------|--|
| 型材   | L3000*W17.3*H14.5mm |  |
| 面罩   |                     |  |
| 堵頭*2 |                     |  |

### ◆ 選購配備 OPTIONAL ACCESSORIES

#### 安裝配件 Installation Accessories

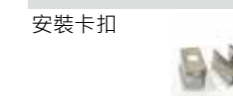

#### 光源配件 Lighting Source

適用 2835 120燈/米 12w/ 3000K / 4000K / 6000K / 5mm / CRI>90  
 適用 2835 182燈/米 15w/ 3000K / 4000K / 6000K / 10mm / CRI>90

## SL1806

- 可應用於間照設計
- 零光斑 · 出光均勻柔和
- 高品質表面處理 · 高品質PC擴散面罩
- 型材、面罩長度一致 · 一刀完成切割



### ◆ 基本參數 BASIC PARAMETERS

|      |           |
|------|-----------|
| 鋁材質  | AL6063-T5 |
| 表面工藝 | 氧化亞銀處理    |
| 面罩材質 | 白色無光點PC罩  |
| 色號   | RAL9003   |

### ◆ 標準配備 STANDARD ACCESSORIES

#### 型材組件 Profile Components

|      |                    |  |
|------|--------------------|--|
| 型材   | L3000*W17.9*H5.7mm |  |
| 面罩   |                    |  |
| 堵頭*2 |                    |  |

### ◆ 選購配備 OPTIONAL ACCESSORIES

#### 安裝配件 Installation Accessories



#### 光源配件 Lighting Source

適用 2835 120燈/米 12w/ 3000K / 4000K / 6000K / 5mm / CRI>90  
 適用 2835 182燈/米 15w/ 3000K / 4000K / 6000K / 10mm / CRI>90

## SL1813

- 可應用於間照設計
- 零光斑 · 出光均勻柔和
- 高品質表面處理 · 高品質PC擴散面罩
- 型材、面罩長度一致 · 一刀完成切割

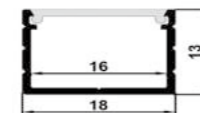

### ◆ 基本參數 BASIC PARAMETERS

|      |           |
|------|-----------|
| 鋁材質  | AL6063-T5 |
| 表面工藝 | 氧化亞銀處理    |
| 面罩材質 | 白色無光點PC罩  |
| 色號   | RAL9003   |

### ◆ 標準配備 STANDARD ACCESSORIES

#### 型材組件 Profile Components

|      |                 |  |
|------|-----------------|--|
| 型材   | L3000*W18*H13mm |  |
| 面罩   |                 |  |
| 堵頭*2 |                 |  |

### ◆ 選購配備 OPTIONAL ACCESSORIES

#### 安裝配件 Installation Accessories



#### 光源配件 Lighting Source

適用 2835 120燈/米 12w/ 3000K / 4000K / 6000K / 5mm / CRI>90  
 適用 2835 182燈/米 15w/ 3000K / 4000K / 6000K / 10mm / CRI>90

## SL1809

- 可應用於間照設計
- 零光斑 · 出光均勻柔和
- 高品質表面處理 · 高品質PC擴散面罩
- 型材、面罩長度一致 · 一刀完成切割

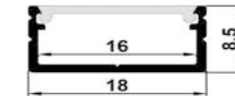

### ◆ 基本參數 BASIC PARAMETERS

|      |           |
|------|-----------|
| 鋁材質  | AL6063-T5 |
| 表面工藝 | 氧化亞銀處理    |
| 面罩材質 | 白色無光點PC罩  |
| 色號   | RAL9003   |

### ◆ 標準配備 STANDARD ACCESSORIES

#### 型材組件 Profile Components

|      |                  |  |
|------|------------------|--|
| 型材   | L3000*W18*H8.5mm |  |
| 面罩   |                  |  |
| 堵頭*2 |                  |  |

### ◆ 選購配備 OPTIONAL ACCESSORIES

#### 安裝配件 Installation Accessories

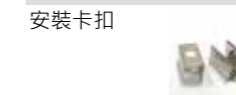

#### 光源配件 Lighting Source

適用 2835 120燈/米 12w/ 3000K / 4000K / 6000K / 5mm / CRI>90  
 適用 2835 182燈/米 15w/ 3000K / 4000K / 6000K / 10mm / CRI>90

## SL1912

- 可應用於間照設計
- 零光斑 · 出光均勻柔和
- 高品質表面處理 · 高品質PC擴散面罩
- 型材、面罩長度一致 · 一刀完成切割

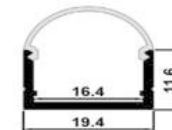

### ◆ 基本參數 BASIC PARAMETERS

|      |           |
|------|-----------|
| 鋁材質  | AL6063-T5 |
| 表面工藝 | 氧化亞銀處理    |
| 面罩材質 | 白色無光點PC罩  |
| 色號   | RAL9003   |

### ◆ 標準配備 STANDARD ACCESSORIES

#### 型材組件 Profile Components

|      |                     |  |
|------|---------------------|--|
| 型材   | L3000*W19.4*H11.6mm |  |
| 面罩   |                     |  |
| 堵頭*2 |                     |  |

### ◆ 選購配備 OPTIONAL ACCESSORIES

#### 安裝配件 Installation Accessories

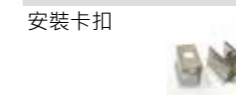

#### 光源配件 Lighting Source

適用 2835 120燈/米 12w/ 3000K / 4000K / 6000K / 5mm / CRI>90  
 適用 2835 182燈/米 15w/ 3000K / 4000K / 6000K / 10mm / CRI>90

## SL1920

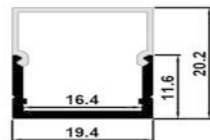

- 可應用於間照設計
- 零光斑 · 出光均勻柔和
- 高品質表面處理 · 高品質PC擴散面罩
- 型材、面罩長度一致 · 一刀完成切割



### ◆ 基本參數 BASIC PARAMETERS

|      |           |
|------|-----------|
| 鋁材質  | AL6063-T5 |
| 表面工藝 | 氧化亞銀處理    |
| 面罩材質 | 白色無光點PC罩  |
| 色號   | RAL9003   |

### ◆ 標準配備 STANDARD ACCESSORIES

| 型材組件 Profile Components |   |
|-------------------------|---|
| 型材                      | L3000*W19.4*H20.2mm  |
| 面罩                      |                      |
| 堵頭*2                    |                      |

### ◆ 選購配備 OPTIONAL ACCESSORIES

| 安裝配件 Installation Accessories                             |  |
|---|--|
| 安裝卡扣  |  |
| 光源配件 Lighting Source                                      |  |
| 適用 2835 120燈/米 12w/ 3000K / 4000K / 6000K / 5mm / CRI>90  |  |
| 適用 2835 182燈/米 15w/ 3000K / 4000K / 6000K / 10mm / CRI>90 |  |

## SL2015

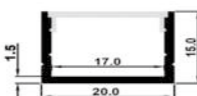

- 可應用於間照設計
- 零光斑 · 出光均勻柔和
- 高品質表面處理 · 高品質PC擴散面罩
- 型材、面罩長度一致 · 一刀完成切割



### ◆ 基本參數 BASIC PARAMETERS

|      |           |
|------|-----------|
| 鋁材質  | AL6063-T5 |
| 表面工藝 | 氧化亞銀處理    |
| 面罩材質 | 白色無光點PC罩  |
| 色號   | RAL9003   |

### ◆ 標準配備 STANDARD ACCESSORIES

| 型材組件 Profile Components |   |
|-------------------------|---|
| 型材                      | L3000*W20*H15mm  |
| 面罩                      |                  |
| 堵頭*2                    |                  |

### ◆ 選購配備 OPTIONAL ACCESSORIES

| 安裝配件 Installation Accessories                             |  |
|---|--|
| 安裝卡扣  |  |
| 光源配件 Lighting Source                                      |  |
| 適用 2835 120燈/米 12w/ 3000K / 4000K / 6000K / 5mm / CRI>90  |  |
| 適用 2835 182燈/米 15w/ 3000K / 4000K / 6000K / 10mm / CRI>90 |  |

## SL2010

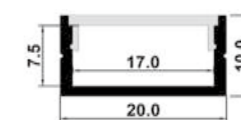

- 可應用於間照設計
- 零光斑 · 出光均勻柔和
- 高品質表面處理 · 高品質PC擴散面罩
- 型材、面罩長度一致 · 一刀完成切割



### ◆ 基本參數 BASIC PARAMETERS

|      |           |
|------|-----------|
| 鋁材質  | AL6063-T5 |
| 表面工藝 | 氧化亞銀處理    |
| 面罩材質 | 白色無光點PC罩  |
| 色號   | RAL9003   |

### ◆ 標準配備 STANDARD ACCESSORIES

| 型材組件 Profile Components |   |
|-------------------------|---|
| 型材                      | L3000*W20*H10mm  |
| 面罩                      |                  |
| 堵頭*2                    |                  |

### ◆ 選購配備 OPTIONAL ACCESSORIES

| 安裝配件 Installation Accessories                             |   |
|---|---|
| 安裝卡扣  |  |
| 光源配件 Lighting Source                                      |   |
| 適用 2835 120燈/米 12w/ 3000K / 4000K / 6000K / 5mm / CRI>90  |   |
| 適用 2835 182燈/米 15w/ 3000K / 4000K / 6000K / 10mm / CRI>90 |   |

## SL2020A

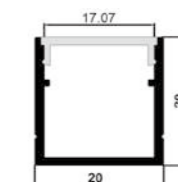

- 可應用於間照設計
- 零光斑 · 出光均勻柔和
- 高品質表面處理 · 高品質PC擴散面罩
- 型材、面罩長度一致 · 一刀完成切割



### ◆ 基本參數 BASIC PARAMETERS

|      |           |
|------|-----------|
| 鋁材質  | AL6063-T5 |
| 表面工藝 | 氧化亞銀處理    |
| 面罩材質 | 白色無光點PC罩  |
| 色號   | RAL9003   |

### ◆ 標準配備 STANDARD ACCESSORIES

| 型材組件 Profile Components |   |
|-------------------------|---|
| 型材                      | L3000*W20*H20mm  |
| 面罩                      |                  |
| 堵頭*2                    |                  |

### ◆ 選購配備 OPTIONAL ACCESSORIES

| 安裝配件 Installation Accessories                             |   |
|---|---|
| 安裝卡扣  |  |
| 光源配件 Lighting Source                                      |   |
| 適用 2835 120燈/米 12w/ 3000K / 4000K / 6000K / 5mm / CRI>90  |   |
| 適用 2835 182燈/米 15w/ 3000K / 4000K / 6000K / 10mm / CRI>90 |   |

## SL2020B

- 可應用於間照設計
- 零光斑 · 出光均勻柔和
- 高品質表面處理 · 高品質PC擴散面罩
- 型材、面罩長度一致 · 一刀完成切割

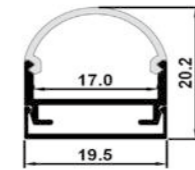

### ◆ 基本參數 BASIC PARAMETERS

|      |           |
|------|-----------|
| 鋁材質  | AL6063-T5 |
| 表面工藝 | 氧化亞銀處理    |
| 面罩材質 | 白色無光點PC罩  |
| 色號   | RAL9003   |

### ◆ 標準配備 STANDARD ACCESSORIES

#### 型材組件 Profile Components

|    |                  |
|----|------------------|
| 型材 | L3000*W16*H8.6mm |
|----|------------------|



#### 面罩



#### 堵頭\*2



### ◆ 選購配備 OPTIONAL ACCESSORIES

#### 安裝配件 Installation Accessories

安裝卡扣

#### 光源配件 Lighting Source

適用 2835 120燈/米 12w/ 3000K / 4000K / 6000K / 5mm / CRI>90  
 適用 2835 182燈/米 15w/ 3000K / 4000K / 6000K / 10mm / CRI>90

## SL2020D

- 可應用於間照設計
- 零光斑 · 出光均勻柔和
- 高品質表面處理 · 高品質PC擴散面罩
- 型材、面罩長度一致 · 一刀完成切割

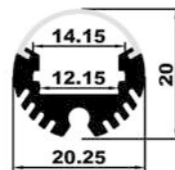

### ◆ 基本參數 BASIC PARAMETERS

|      |           |
|------|-----------|
| 鋁材質  | AL6063-T5 |
| 表面工藝 | 氧化亞銀處理    |
| 面罩材質 | 白色無光點PC罩  |
| 色號   | RAL9003   |

### ◆ 標準配備 STANDARD ACCESSORIES

#### 型材組件 Profile Components

|    |                    |
|----|--------------------|
| 型材 | L3000*W20.25*H20mm |
|----|--------------------|



#### 面罩



#### 堵頭\*2



### ◆ 選購配備 OPTIONAL ACCESSORIES

#### 安裝配件 Installation Accessories

安裝卡扣



#### 光源配件 Lighting Source

適用 2835 120燈/米 12w/ 3000K / 4000K / 6000K / 5mm / CRI>90  
 適用 2835 182燈/米 15w/ 3000K / 4000K / 6000K / 10mm / CRI>90

## SL2020C

- 可應用於間照設計
- 零光斑 · 出光均勻柔和
- 高品質表面處理 · 高品質PC擴散面罩
- 型材、面罩長度一致 · 一刀完成切割

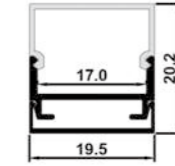

### ◆ 基本參數 BASIC PARAMETERS

|      |           |
|------|-----------|
| 鋁材質  | AL6063-T5 |
| 表面工藝 | 氧化亞銀處理    |
| 面罩材質 | 白色無光點PC罩  |
| 色號   | RAL9003   |

### ◆ 標準配備 STANDARD ACCESSORIES

#### 型材組件 Profile Components

|    |                     |
|----|---------------------|
| 型材 | L3000*W19.5*H20.2mm |
|----|---------------------|



#### 面罩



#### 堵頭\*2



### ◆ 選購配備 OPTIONAL ACCESSORIES

#### 安裝配件 Installation Accessories

安裝卡扣

#### 光源配件 Lighting Source

適用 2835 120燈/米 12w/ 3000K / 4000K / 6000K / 5mm / CRI>90  
 適用 2835 182燈/米 15w/ 3000K / 4000K / 6000K / 10mm / CRI>90

## SL2027A

- 可應用於間照設計
- 零光斑 · 出光均勻柔和
- 高品質表面處理 · 高品質PC擴散面罩
- 型材、面罩長度一致 · 一刀完成切割

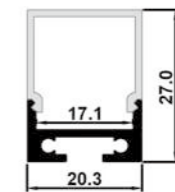

### ◆ 基本參數 BASIC PARAMETERS

|      |           |
|------|-----------|
| 鋁材質  | AL6063-T5 |
| 表面工藝 | 氧化亞銀處理    |
| 面罩材質 | 白色無光點PC罩  |
| 色號   | RAL9003   |

### ◆ 標準配備 STANDARD ACCESSORIES

#### 型材組件 Profile Components

|    |                  |
|----|------------------|
| 型材 | L3000*W16*H8.6mm |
|----|------------------|



#### 面罩



#### 堵頭\*2



### ◆ 選購配備 OPTIONAL ACCESSORIES

#### 安裝配件 Installation Accessories

安裝卡扣



#### 光源配件 Lighting Source

適用 2835 120燈/米 12w/ 3000K / 4000K / 6000K / 8mm / CRI>90  
 適用 2835 240燈/米 24w/ 3000K / 4000K / 6000K / 10mm / CRI>90

## SL2027B

- 應用各種間照設計
- 零光斑，出光均勻柔和
- 高品質表面處理，高品質PC擴散面罩
- 型材、面罩長度一致，一刀完成切割

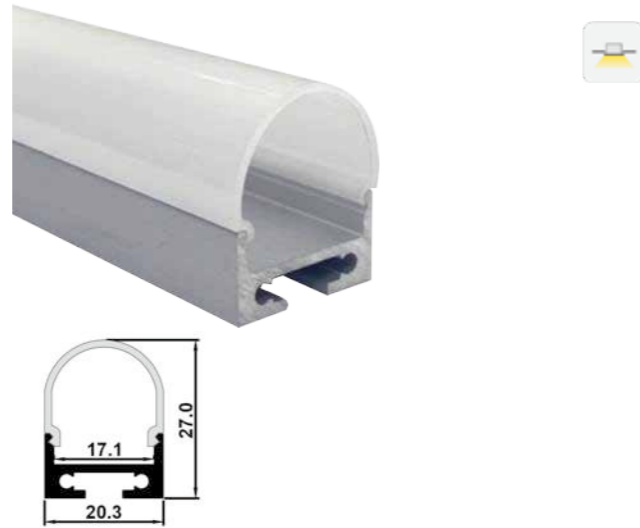

### ◆ 基本參數 BASIC PARAMETERS

|      |           |
|------|-----------|
| 鋁材質  | AL6063-T5 |
| 表面工藝 | 氧化亞銀處理    |
| 面罩材質 | 白色無光點PC罩  |
| 色號   | RAL9003   |

### ◆ 標準配備 STANDARD ACCESSORIES

#### 型材組件 Profile Components

|      |                  |  |
|------|------------------|--|
| 型材   | L3000*W16*H8.6mm |  |
| 面罩   |                  |  |
| 堵頭*2 |                  |  |

### ◆ 選購配備 OPTIONAL ACCESSORIES

#### 安裝配件 Installation Accessories



#### 光源配件 Lighting Source

適用 2835 120燈/米 12w/ 3000K / 4000K / 6000K / 8mm / CRI>90  
 適用 2835 240燈/米 24w/ 3000K / 4000K / 6000K / 10mm / CRI>90

## SL2410B

- 應用各種間照設計
- 零光斑，出光均勻柔和
- 高品質表面處理，高品質PC擴散面罩
- 型材、面罩長度一致，一刀完成切割

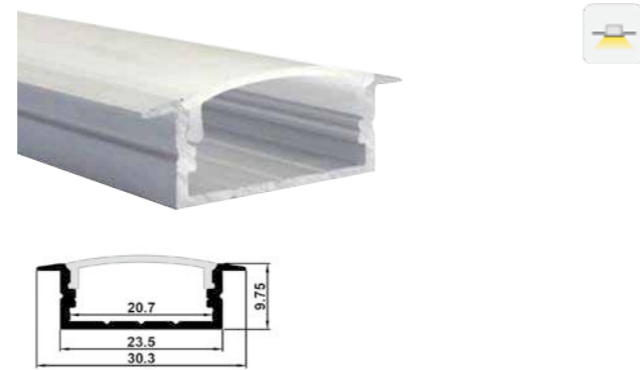

### ◆ 基本參數 BASIC PARAMETERS

|      |           |
|------|-----------|
| 鋁材質  | AL6063-T5 |
| 表面工藝 | 氧化亞銀處理    |
| 面罩材質 | 白色無光點PC罩  |
| 色號   | RAL9003   |

### ◆ 標準配備 STANDARD ACCESSORIES

#### 型材組件 Profile Components

|      |                     |  |
|------|---------------------|--|
| 型材   | L3000*W23.5*H9.75mm |  |
| 面罩   |                     |  |
| 堵頭*2 |                     |  |

### ◆ 選購配備 OPTIONAL ACCESSORIES

#### 安裝配件 Installation Accessories



#### 光源配件 Lighting Source

適用 2835 120燈/米 12w/ 3000K / 4000K / 6000K / 5mm / CRI>90  
 適用 2835 182燈/米 15w/ 3000K / 4000K / 6000K / 10mm / CRI>90

## SL2410A

- 應用各種間照設計
- 零光斑，出光均勻柔和
- 高品質表面處理，高品質PC擴散面罩
- 型材、面罩長度一致，一刀完成切割

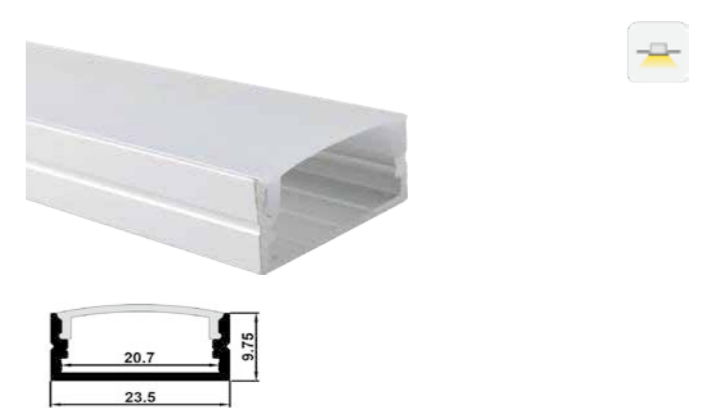

### ◆ 基本參數 BASIC PARAMETERS

|      |           |
|------|-----------|
| 鋁材質  | AL6063-T5 |
| 表面工藝 | 氧化亞銀處理    |
| 面罩材質 | 白色無光點PC罩  |
| 色號   | RAL9003   |

### ◆ 標準配備 STANDARD ACCESSORIES

#### 型材組件 Profile Components

|      |                     |  |
|------|---------------------|--|
| 型材   | L3000*W23.5*H9.75mm |  |
| 面罩   |                     |  |
| 堵頭*2 |                     |  |

### ◆ 選購配備 OPTIONAL ACCESSORIES

#### 安裝配件 Installation Accessories



#### 光源配件 Lighting Source

適用 2835 120燈/米 12w/ 3000K / 4000K / 6000K / 5mm / CRI>90  
 適用 2835 182燈/米 15w/ 3000K / 4000K / 6000K / 10mm / CRI>90

## SL2420A

- 應用各種間照設計
- 零光斑，出光均勻柔和
- 高品質表面處理，高品質PC擴散面罩
- 型材、面罩長度一致，一刀完成切割

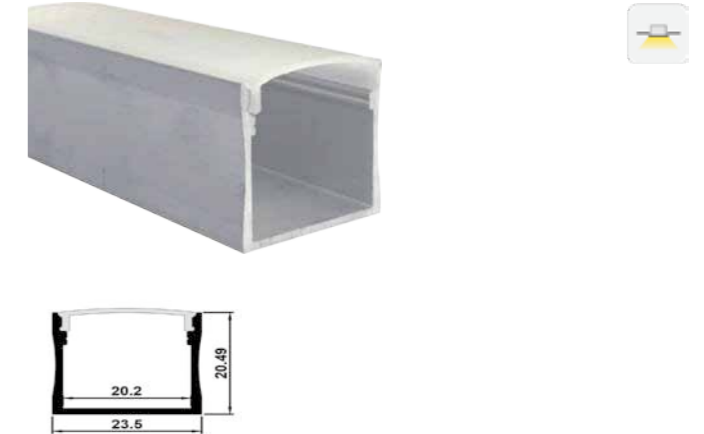

### ◆ 基本參數 BASIC PARAMETERS

|      |           |
|------|-----------|
| 鋁材質  | AL6063-T5 |
| 表面工藝 | 氧化亞銀處理    |
| 面罩材質 | 白色無光點PC罩  |
| 色號   | RAL9003   |

### ◆ 標準配備 STANDARD ACCESSORIES

#### 型材組件 Profile Components

|      |                     |  |
|------|---------------------|--|
| 型材   | L3000*W2.5*H20.49mm |  |
| 面罩   |                     |  |
| 堵頭*2 |                     |  |

### ◆ 選購配備 OPTIONAL ACCESSORIES

#### 安裝配件 Installation Accessories

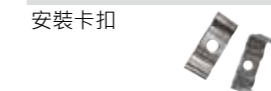

#### 光源配件 Lighting Source

適用 2835 120燈/米 12w/ 3000K / 4000K / 6000K / 5mm / CRI>90  
 適用 2835 182燈/米 15w/ 3000K / 4000K / 6000K / 10mm / CRI>90

## SL2420B



- 可應用於各種狹小空間
- 零光斑，出光均勻柔和
- 高品質表面處理，高品質PC擴散面罩
- 型材、面罩長度一致，一刀完成切割



### ◆ 基本參數 BASIC PARAMETERS

|      |           |
|------|-----------|
| 鋁材質  | AL6063-T5 |
| 表面工藝 | 氧化亞銀處理    |
| 面罩材質 | 白色無光點PC罩  |
| 色號   | RAL9003   |

### ◆ 標準配備 STANDARD ACCESSORIES

| 型材組件 Profile Components |  |
|-------------------------|--|
| 型材                      | L3000*W23.5*H20.49mm  |
| 面罩                      |                       |
| 堵頭*2                    |                       |

### ◆ 選購配備 OPTIONAL ACCESSORIES

| 安裝配件 Installation Accessories                             |  |
|---|--|
| 安裝卡扣  |  |
| 光源配件 Lighting Source                                      |  |
| 適用 2835 120燈/米 12w/ 3000K / 4000K / 6000K / 5mm / CRI>90  |  |
| 適用 2835 182燈/米 15w/ 3000K / 4000K / 6000K / 10mm / CRI>90 |  |

## SL2325

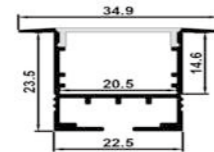

- 可應用於各種狹小空間
- 零光斑，出光均勻柔和
- 高品質表面處理，高品質PC擴散面罩
- 型材、面罩長度一致，一刀完成切割



### ◆ 基本參數 BASIC PARAMETERS

|      |           |
|------|-----------|
| 鋁材質  | AL6063-T5 |
| 表面工藝 | 氧化亞銀處理    |
| 面罩材質 | 白色無光點PC罩  |
| 色號   | RAL9003   |

### ◆ 標準配備 STANDARD ACCESSORIES

| 型材組件 Profile Components |   |
|-------------------------|---|
| 型材                      | L3000*W22.5*H23.5mm  |
| 面罩                      |                      |
| 堵頭*2                    |                      |

### ◆ 選購配備 OPTIONAL ACCESSORIES

| 安裝配件 Installation Accessories                             |  |
|---|--|
| 安裝卡扣  |  |
| 光源配件 Lighting Source                                      |  |
| 適用 2835 120燈/米 12w/ 3000K / 4000K / 6000K / 5mm / CRI>90  |  |
| 適用 2835 182燈/米 15w/ 3000K / 4000K / 6000K / 10mm / CRI>90 |  |

## SL2525

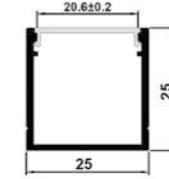

- 應用各種間照設計
- 零光斑，出光均勻柔和
- 高品質表面處理，高品質PC擴散面罩
- 型材、面罩長度一致，一刀完成切割



### ◆ 基本參數 BASIC PARAMETERS

|      |           |
|------|-----------|
| 鋁材質  | AL6063-T5 |
| 表面工藝 | 氧化亞銀處理    |
| 面罩材質 | 白色無光點PC罩  |
| 色號   | RAL9003   |

### ◆ 標準配備 STANDARD ACCESSORIES

| 型材組件 Profile Components |   |
|-------------------------|---|
| 型材                      | L3000*W25*H25mm  |
| 面罩                      |                  |
| 堵頭*2                    |                  |

### ◆ 選購配備 OPTIONAL ACCESSORIES

| 安裝配件 Installation Accessories                             |   |
|---|---|
| 安裝卡扣  |  |
| 光源配件 Lighting Source                                      |   |
| 適用 2835 120燈/米 12w/ 3000K / 4000K / 6000K / 5mm / CRI>90  |   |
| 適用 2835 182燈/米 15w/ 3000K / 4000K / 6000K / 10mm / CRI>90 |   |

## SL2545

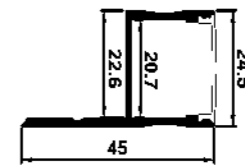

- 可應用於各種狹小空間
- 零光斑，出光均勻柔和
- 高品質表面處理，高品質PC擴散面罩
- 型材、面罩長度一致，一刀完成切割



### ◆ 基本參數 BASIC PARAMETERS

|      |           |
|------|-----------|
| 鋁材質  | AL6063-T5 |
| 表面工藝 | 氧化亞銀處理    |
| 面罩材質 | 白色無光點PC罩  |
| 色號   | RAL9003   |

### ◆ 標準配備 STANDARD ACCESSORIES

| 型材組件 Profile Components |   |
|-------------------------|---|
| 型材                      | L3000*W24.5*H45mm  |
| 面罩                      |                    |
| 堵頭*2                    |                    |

### ◆ 選購配備 OPTIONAL ACCESSORIES

| 安裝配件 Installation Accessories                             |   |
|---|---|
| 安裝卡扣  |  |
| 光源配件 Lighting Source                                      |   |
| 適用 2835 120燈/米 12w/ 3000K / 4000K / 6000K / 5mm / CRI>90  |   |
| 適用 2835 182燈/米 15w/ 3000K / 4000K / 6000K / 10mm / CRI>90 |   |

## SL2626A

- 應用各種間照設計
- 零光斑 · 出光均勻柔和
- 高品質表面處理 · 高品質PC擴散面罩
- 型材、面罩長度一致 · 一刀完成切割

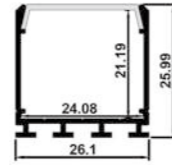

### ◆ 基本參數 BASIC PARAMETERS

|      |           |
|------|-----------|
| 鋁材質  | AL6063-T5 |
| 表面工藝 | 氧化亞銀處理    |
| 面罩材質 | 白色無光點PC罩  |
| 色號   | RAL9003   |

### ◆ 標準配備 STANDARD ACCESSORIES

#### 型材組件 Profile Components

型材 L3000\*W26.1\*H25.99mm



面罩



堵頭\*2



### 選購配備 OPTIONAL ACCESSORIES

#### 安裝配件 Installation Accessories

安裝卡扣



#### 光源配件 Lighting Source

適用 2835 120燈/米 12w/ 3000K / 4000K / 6000K / 5mm / CRI>90  
適用 2835 182燈/米 15w/ 3000K / 4000K / 6000K / 10mm / CRI>90

## SL2626B

- 可應用於各種空間
- 零光斑 · 出光均勻柔和
- 高品質表面處理 · 高品質PC擴散面罩
- 型材、面罩長度一致 · 一刀完成切割

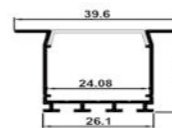

### ◆ 基本參數 BASIC PARAMETERS

|      |           |
|------|-----------|
| 鋁材質  | AL6063-T5 |
| 表面工藝 | 氧化亞銀處理    |
| 面罩材質 | 白色無光點PC罩  |
| 色號   | RAL9003   |

### ◆ 標準配備 STANDARD ACCESSORIES

#### 型材組件 Profile Components

型材 L3000\*W26.1\*H25.99mm



面罩



堵頭\*2



### 選購配備 OPTIONAL ACCESSORIES

#### 安裝配件 Installation Accessories

安裝卡扣



#### 光源配件 Lighting Source

適用 2835 120燈/米 12w/ 3000K / 4000K / 6000K / 5mm / CRI>90  
適用 2835 182燈/米 15w/ 3000K / 4000K / 6000K / 10mm / CRI>90

## SL3010

- 可應用於各種空間
- 零光斑 · 出光均勻柔和
- 高品質表面處理 · 高品質PC擴散面罩
- 型材、面罩長度一致 · 一刀完成切割

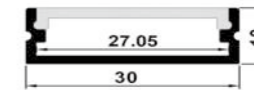

### ◆ 基本參數 BASIC PARAMETERS

|      |           |
|------|-----------|
| 鋁材質  | AL6063-T5 |
| 表面工藝 | 氧化亞銀處理    |
| 面罩材質 | 白色無光點PC罩  |
| 色號   | RAL9003   |

### ◆ 標準配備 STANDARD ACCESSORIES

#### 型材組件 Profile Components

型材 L3000\*W30\*H10mm



面罩



堵頭\*2



### ◆ 選購配備 OPTIONAL ACCESSORIES

#### 安裝配件 Installation Accessories

安裝卡扣



#### 光源配件 Lighting Source

適用 2835 120燈/米 12w/ 3000K / 4000K / 6000K / 5mm / CRI>90  
適用 2835 182燈/米 15w/ 3000K / 4000K / 6000K / 10mm / CRI>90

## SL3020

- 可應用於各種空間
- 零光斑 · 出光均勻柔和
- 高品質表面處理 · 高品質PC擴散面罩
- 型材、面罩長度一致 · 一刀完成切割

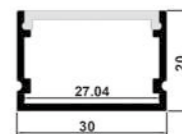

### ◆ 基本參數 BASIC PARAMETERS

|      |           |
|------|-----------|
| 鋁材質  | AL6063-T5 |
| 表面工藝 | 氧化亞銀處理    |
| 面罩材質 | 白色無光點PC罩  |
| 色號   | RAL9003   |

### ◆ 標準配備 STANDARD ACCESSORIES

#### 型材組件 Profile Components

型材 L3000\*W30\*H20mm



面罩



堵頭\*2



### ◆ 選購配備 OPTIONAL ACCESSORIES

#### 安裝配件 Installation Accessories

安裝卡扣



#### 光源配件 Lighting Source

適用 2835 120燈/米 12w/ 3000K / 4000K / 6000K / 5mm / CRI>90  
適用 2835 182燈/米 15w/ 3000K / 4000K / 6000K / 10mm / CRI>90



## SL3030

- 可應用於各種空間
- 零光斑 · 出光均勻柔和
- 高品質表面處理 · 高品質PC擴散面罩
- 型材、面罩長度一致 · 一刀完成切割

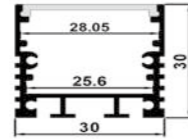



### ◆ 基本參數 BASIC PARAMETERS

|      |           |
|------|-----------|
| 鋁材質  | AL6063-T5 |
| 表面工藝 | 氧化亞銀處理    |
| 面罩材質 | 白色無光點PC罩  |
| 色號   | RAL9003   |

### ◆ 標準配備 STANDARD ACCESSORIES

#### 型材組件 Profile Components

|      |                 |   |
|------|-----------------|---|
| 型材   | L3000*W30*H30mm |  |
| 面罩   |                 |  |
| 堵頭*2 |                 |   |

### ◆ 選購配備 OPTIONAL ACCESSORIES

#### 安裝配件 Installation Accessories



#### 光源配件 Lighting Source

適用 2835 120燈/米 12w/ 3000K / 4000K / 6000K / 5mm / CRI>90  
 適用 2835 182燈/米 15w/ 3000K / 4000K / 6000K / 10mm / CRI>90



## SL3030-1

- 可應用於各種空間
- 零光斑 · 出光均勻柔和
- 高品質表面處理 · 高品質PC擴散面罩
- 型材、面罩長度一致 · 一刀完成切割

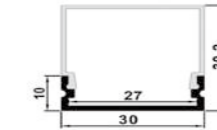

### ◆ 基本參數 BASIC PARAMETERS

|      |           |
|------|-----------|
| 鋁材質  | AL6063-T5 |
| 表面工藝 | 氧化亞銀處理    |
| 面罩材質 | 白色無光點PC罩  |
| 色號   | RAL9003   |

### ◆ 標準配備 STANDARD ACCESSORIES

#### 型材組件 Profile Components

|      |                   |   |
|------|-------------------|---|
| 型材   | L3000*W30*H30.2mm |  |
| 面罩   |                   |  |
| 堵頭*2 |                   |   |

### ◆ 選購配備 OPTIONAL ACCESSORIES

#### 安裝配件 Installation Accessories



#### 光源配件 Lighting Source

適用 2835 120燈/米 12w/ 3000K / 4000K / 6000K / 5mm / CRI>90  
 適用 2835 182燈/米 15w/ 3000K / 4000K / 6000K / 10mm / CRI>90

## SL3030-2

- 可應用於各種空間
- 零光斑 · 出光均勻柔和
- 高品質表面處理 · 高品質PC擴散面罩
- 型材、面罩長度一致 · 一刀完成切割

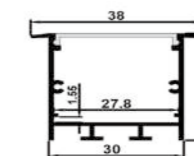



### ◆ 基本參數 BASIC PARAMETERS

|      |           |
|------|-----------|
| 鋁材質  | AL6063-T5 |
| 表面工藝 | 氧化亞銀處理    |
| 面罩材質 | 白色無光點PC罩  |
| 色號   | RAL9003   |

### ◆ 標準配備 STANDARD ACCESSORIES

#### 型材組件 Profile Components

|      |                 |   |
|------|-----------------|---|
| 型材   | L3000*W30*H30mm |  |
| 面罩   |                 |  |
| 堵頭*2 |                 |   |

### ◆ 選購配備 OPTIONAL ACCESSORIES

#### 安裝配件 Installation Accessories



#### 光源配件 Lighting Source

適用 2835 120燈/米 12w/ 3000K / 4000K / 6000K / 8mm / CRI>90  
 適用 2835 240燈/米 24w/ 3000K / 4000K / 6000K / 10mm / CRI>90

## SL3420

- 可應用於各種空間
- 零光斑 · 出光均勻柔和
- 高品質表面處理 · 高品質PC擴散面罩
- 型材、面罩長度一致 · 一刀完成切割

### ◆ 基本參數 BASIC PARAMETERS

|      |           |
|------|-----------|
| 鋁材質  | AL6063-T5 |
| 表面工藝 | 氧化亞銀處理    |
| 面罩材質 | 白色無光點PC罩  |
| 色號   | RAL9003   |

### ◆ 標準配備 STANDARD ACCESSORIES

#### 型材組件 Profile Components

|    |                 |
|----|-----------------|
| 型材 | L3000*W34*H20mm |
|----|-----------------|

面罩

堵頭\*2

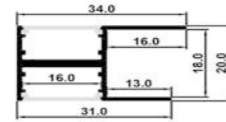

### ◆ 選購配備 OPTIONAL ACCESSORIES

#### 安裝配件 Installation Accessories

安裝卡扣

#### 光源配件 Lighting Source

適用 2835 120燈/米 12w/ 3000K / 4000K / 6000K / 8mm / CRI>90  
適用 2835 240燈/米 24w/ 3000K / 4000K / 6000K / 10mm / CRI>90

## SL3373

- 可應用於各種空間
- 零光斑 · 出光均勻柔和
- 高品質表面處理 · 高品質PC擴散面罩
- 型材、面罩長度一致 · 一刀完成切割

### ◆ 基本參數 BASIC PARAMETERS

|      |           |
|------|-----------|
| 鋁材質  | AL6063-T5 |
| 表面工藝 | 氧化亞銀處理    |
| 面罩材質 | 白色無光點PC罩  |
| 色號   | RAL9003   |

### ◆ 標準配備 STANDARD ACCESSORIES

#### 型材組件 Profile Components

|    |                   |
|----|-------------------|
| 型材 | L3000*W33.4*H73mm |
|----|-------------------|

面罩

堵頭\*2

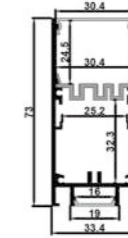

### ◆ 選購配備 OPTIONAL ACCESSORIES

#### 安裝配件 Installation Accessories

安裝卡扣

#### 光源配件 Lighting Source

適用 2835 120燈/米 12w/ 3000K / 4000K / 6000K / 5mm / CRI>90  
適用 2835 182燈/米 15w/ 3000K / 4000K / 6000K / 10mm / CRI>90

## SL3535A

- 可應用於各種空間
- 零光斑 · 出光均勻柔和
- 高品質表面處理 · 高品質PC擴散面罩
- 型材、面罩長度一致 · 一刀完成切割

### ◆ 基本參數 BASIC PARAMETERS

|      |           |
|------|-----------|
| 鋁材質  | AL6063-T5 |
| 表面工藝 | 氧化亞銀處理    |
| 面罩材質 | 白色無光點PC罩  |
| 色號   | RAL9003   |

### ◆ 標準配備 STANDARD ACCESSORIES

#### 型材組件 Profile Components

|    |                 |
|----|-----------------|
| 型材 | L3000*W35*H35mm |
|----|-----------------|

面罩

堵頭\*2

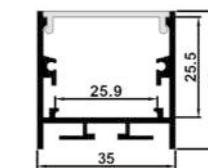

### ◆ 選購配備 OPTIONAL ACCESSORIES

#### 安裝配件 Installation Accessories

安裝卡扣

#### 光源配件 Lighting Source

適用 2835 120燈/米 12w/ 3000K / 4000K / 6000K / 5mm / CRI>90  
適用 2835 182燈/米 15w/ 3000K / 4000K / 6000K / 10mm / CRI>90

## SL3535B

- 可應用於各種空間
- 零光斑 · 出光均勻柔和
- 高品質表面處理 · 高品質PC擴散面罩
- 型材、面罩長度一致 · 一刀完成切割

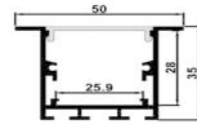

### ◆ 基本參數 BASIC PARAMETERS

|      |           |
|------|-----------|
| 鋁材質  | AL6063-T5 |
| 表面工藝 | 氧化亞銀處理    |
| 面罩材質 | 白色無光點PC罩  |
| 色號   | RAL9003   |

### ◆ 標準配備 STANDARD ACCESSORIES

#### 型材組件 Profile Components

|      |                 |  |
|------|-----------------|--|
| 型材   | L3000*W35*H35mm |  |
| 面罩   |                 |  |
| 堵頭*2 |                 |  |

### ◆ 選購配備 OPTIONAL ACCESSORIES

#### 安裝配件 Installation Accessories



#### 光源配件 Lighting Source

適用 2835 120燈/米 12w/ 3000K / 4000K / 6000K / 5mm / CRI>90  
 適用 2835 182燈/米 15w/ 3000K / 4000K / 6000K / 10mm / CRI>90

## SL3575

- 可應用於各種空間
- 零光斑 · 出光均勻柔和
- 高品質表面處理 · 高品質PC擴散面罩
- 型材、面罩長度一致 · 一刀完成切割

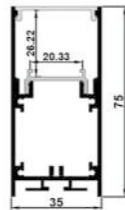

### ◆ 基本參數 BASIC PARAMETERS

|      |           |
|------|-----------|
| 鋁材質  | AL6063-T5 |
| 表面工藝 | 氧化亞銀處理    |
| 面罩材質 | 白色無光點PC罩  |
| 色號   | RAL9003   |

### ◆ 標準配備 STANDARD ACCESSORIES

#### 型材組件 Profile Components

|      |                 |  |
|------|-----------------|--|
| 型材   | L3000*W35*H75mm |  |
| 面罩   |                 |  |
| 堵頭*2 |                 |  |

### ◆ 選購配備 OPTIONAL ACCESSORIES

#### 安裝配件 Installation Accessories



#### 光源配件 Lighting Source

適用 2835 120燈/米 12w/ 3000K / 4000K / 6000K / 5mm / CRI>90  
 適用 2835 182燈/米 15w/ 3000K / 4000K / 6000K / 10mm / CRI>90

## SL3573

- 可應用於各種空間
- 零光斑 · 出光均勻柔和
- 高品質表面處理 · 高品質PC擴散面罩
- 型材、面罩長度一致 · 一刀完成切割

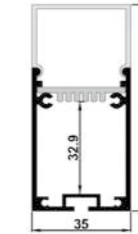

### ◆ 基本參數 BASIC PARAMETERS

|      |           |
|------|-----------|
| 鋁材質  | AL6063-T5 |
| 表面工藝 | 氧化亞銀處理    |
| 面罩材質 | 白色無光點PC罩  |
| 色號   | RAL9003   |

### ◆ 標準配備 STANDARD ACCESSORIES

#### 型材組件 Profile Components

|      |                   |  |
|------|-------------------|--|
| 型材   | L3000*W35*H73.4mm |  |
| 面罩   |                   |  |
| 堵頭*2 |                   |  |

### ◆ 選購配備 OPTIONAL ACCESSORIES

#### 安裝配件 Installation Accessories



#### 光源配件 Lighting Source

適用 2835 120燈/米 12w/ 3000K / 4000K / 6000K / 5mm / CRI>90  
 適用 2835 182燈/米 15w/ 3000K / 4000K / 6000K / 10mm / CRI>90

## SL4035

- 可應用於各種空間
- 零光斑 · 出光均勻柔和
- 高品質表面處理 · 高品質PC擴散面罩
- 型材、面罩長度一致 · 一刀完成切割

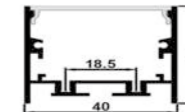

### ◆ 基本參數 BASIC PARAMETERS

|      |           |
|------|-----------|
| 鋁材質  | AL6063-T5 |
| 表面工藝 | 氧化亞銀處理    |
| 面罩材質 | 白色無光點PC罩  |
| 色號   | RAL9003   |

### ◆ 標準配備 STANDARD ACCESSORIES

#### 型材組件 Profile Components

|      |                 |  |
|------|-----------------|--|
| 型材   | L3000*W40*H35mm |  |
| 面罩   |                 |  |
| 堵頭*2 |                 |  |

### ◆ 選購配備 OPTIONAL ACCESSORIES

#### 安裝配件 Installation Accessories



#### 光源配件 Lighting Source

適用 2835 120燈/米 12w/ 3000K / 4000K / 6000K / 5mm / CRI>90  
 適用 2835 182燈/米 15w/ 3000K / 4000K / 6000K / 10mm / CRI>90

## SL4035B

- 可應用於各種空間
- 零光斑 · 出光均勻柔和
- 高品質表面處理 · 高品質PC擴散面罩
- 型材、面罩長度一致 · 一刀完成切割

### ◆ 基本參數 BASIC PARAMETERS

|      |           |
|------|-----------|
| 鋁材質  | AL6063-T5 |
| 表面工藝 | 氧化亞銀處理    |
| 面罩材質 | 白色無光點PC罩  |
| 色號   | RAL9003   |

### ◆ 標準配備 STANDARD ACCESSORIES

#### 型材組件 Profile Components

|    |                 |
|----|-----------------|
| 型材 | L3000*W40*H35mm |
|----|-----------------|

面罩

堵頭\*2

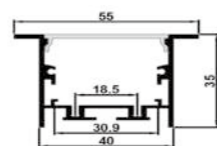

### ◆ 選購配備 OPTIONAL ACCESSORIES

#### 安裝配件 Installation Accessories

安裝卡扣



#### 光源配件 Lighting Source

## SL4290

- 可應用於各種空間
- 零光斑 · 出光均勻柔和
- 高品質表面處理 · 高品質PC擴散面罩
- 型材、面罩長度一致 · 一刀完成切割

適用 2835 120燈/米 5w/ 3000K / 4000K / 6000K / 5mm / CRI>90  
 適用 2835 120燈/米 9w/ 3000K / 4000K / 6000K / 5mm / CRI>90  
 適用 2835 182燈/米 13w/ 3000K / 4000K / 6000K / 10mm / CRI>90  
 適用 2835 240燈/米 15w/ 3000K / 4000K / 6000K / 16mm / CRI>90

### ◆ 基本參數 BASIC PARAMETERS

|      |           |
|------|-----------|
| 鋁材質  | AL6063-T5 |
| 表面工藝 | 氧化亞銀處理    |
| 面罩材質 | 白色無光點PC罩  |
| 色號   | RAL9003   |

### ◆ 標準配備 STANDARD ACCESSORIES

#### 型材組件 Profile Components

|    |                   |
|----|-------------------|
| 型材 | L3000*W42.3*H90mm |
|----|-------------------|

面罩

堵頭\*2

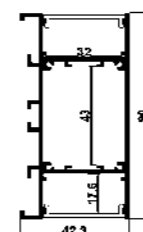

### ◆ 選購配備 OPTIONAL ACCESSORIES

#### 安裝配件 Installation Accessories

安裝卡扣



#### 光源配件 Lighting Source

適用 2835 120燈/米 12w/ 3000K / 4000K / 6000K / 5mm / CRI>90  
 適用 2835 182燈/米 15w/ 3000K / 4000K / 6000K / 10mm / CRI>90

## SL5035A

- 可應用於各種空間
- 零光斑 · 出光均勻柔和
- 高品質表面處理 · 高品質PC擴散面罩
- 型材、面罩長度一致 · 一刀完成切割

### ◆ 基本參數 BASIC PARAMETERS

|      |           |
|------|-----------|
| 鋁材質  | AL6063-T5 |
| 表面工藝 | 氧化亞銀處理    |
| 面罩材質 | 白色無光點PC罩  |
| 色號   | RAL9003   |

### ◆ 標準配備 STANDARD ACCESSORIES

#### 型材組件 Profile Components

|    |                 |
|----|-----------------|
| 型材 | L3000*W50*H35mm |
|----|-----------------|

面罩

堵頭\*2

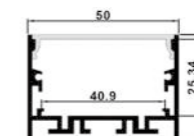

### ◆ 選購配備 OPTIONAL ACCESSORIES

#### 安裝配件 Installation Accessories

安裝卡扣



#### 光源配件 Lighting Source

適用 2835 120燈/米 12w/ 3000K / 4000K / 6000K / 5mm / CRI>90  
 適用 2835 182燈/米 15w/ 3000K / 4000K / 6000K / 10mm / CRI>90

## SL5035B

- 可應用於各種空間
- 零光斑 · 出光均勻柔和
- 高品質表面處理 · 高品質PC擴散面罩
- 型材、面罩長度一致 · 一刀完成切割

適用 2835 120燈/米 9w/ 3000K / 4000K / 6000K / 5mm / CRI>90  
 適用 2835 182燈/米 13w/ 3000K / 4000K / 6000K / 10mm / CRI>90  
 適用 2835 240燈/米 15w/ 3000K / 4000K / 6000K / 16mm / CRI>90

### ◆ 基本參數 BASIC PARAMETERS

|      |           |
|------|-----------|
| 鋁材質  | AL6063-T5 |
| 表面工藝 | 氧化亞銀處理    |
| 面罩材質 | 白色無光點PC罩  |
| 色號   | RAL9003   |

### ◆ 標準配備 STANDARD ACCESSORIES

#### 型材組件 Profile Components

|    |                  |
|----|------------------|
| 型材 | L3000*W50*H35 mm |
|----|------------------|

面罩

堵頭\*2

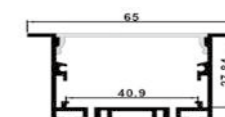

### ◆ 選購配備 OPTIONAL ACCESSORIES

#### 安裝配件 Installation Accessories

安裝卡扣



#### 光源配件 Lighting Source

適用 2835 120燈/米 12w/ 3000K / 4000K / 6000K / 5mm / CRI>90  
 適用 2835 182燈/米 15w/ 3000K / 4000K / 6000K / 10mm / CRI>90

## SL5050



- 可應用於各種空間
- 零光斑 · 出光均勻柔和
- 高品質表面處理 · 高品質PC擴散面罩
- 型材、面罩長度一致 · 一刀完成切割

適用 2835 120燈/米 9w/ 3000K / 4000K / 6000K / 5mm / CRI>90  
 適用 2835 240燈/米 15w/ 3000K / 4000K / 6000K / 16mm / CRI>90

### ◆ 基本參數 BASIC PARAMETERS

|      |           |
|------|-----------|
| 鋁材質  | AL6063-T5 |
| 表面工藝 | 氧化亞銀處理    |
| 面罩材質 | 白色無光點PC罩  |
| 色號   | RAL9003   |

### ◆ 標準配備 STANDARD ACCESSORIES

| 型材組件 Profile Components |  |
|-------------------------|--|
| 型材                      | L3000*W50*H50 mm  |
| 面罩                      |                   |
| 堵頭*2                    |  |

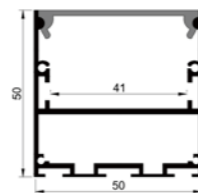
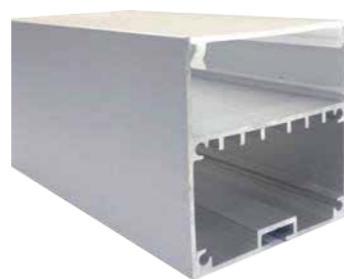

### ◆ 選購配備 OPTIONAL ACCESSORIES

| 安裝配件 Installation Accessories                             |  |
|---|--|
| 安裝卡扣  |  |
| 光源配件 Lighting Source                                      |  |
| 適用 2835 120燈/米 12w/ 3000K / 4000K / 6000K / 5mm / CRI>90  |  |
| 適用 2835 182燈/米 15w/ 3000K / 4000K / 6000K / 10mm / CRI>90 |  |

## SL5075



- 可應用於各種空間
- 零光斑 · 出光均勻柔和
- 高品質表面處理 · 高品質PC擴散面罩
- 型材、面罩長度一致 · 一刀完成切割

適用 2835 120燈/米 9w/ 3000K / 4000K / 6000K / 5mm / CRI>90  
 適用 2835 240燈/米 15w/ 3000K / 4000K / 6000K / 16mm / CRI>90

### ◆ 基本參數 BASIC PARAMETERS

|      |           |
|------|-----------|
| 鋁材質  | AL6063-T5 |
| 表面工藝 | 氧化亞銀處理    |
| 面罩材質 | 白色無光點PC罩  |
| 色號   | RAL9003   |

### ◆ 標準配備 STANDARD ACCESSORIES

| 型材組件 Profile Components |  |
|-------------------------|--|
| 型材                      | L3000*W50*H75 mm  |
| 面罩                      |                   |
| 堵頭*2                    |  |

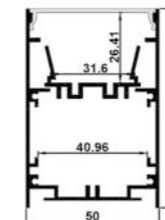
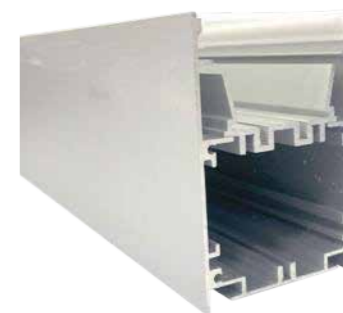

### ◆ 選購配備 OPTIONAL ACCESSORIES

| 安裝配件 Installation Accessories                             |   |
|---|---|
| 安裝卡扣  |  |
| 光源配件 Lighting Source                                      |   |
| 適用 2835 120燈/米 12w/ 3000K / 4000K / 6000K / 5mm / CRI>90  |   |
| 適用 2835 182燈/米 15w/ 3000K / 4000K / 6000K / 10mm / CRI>90 |   |

## SL5076



- 可應用於各種空間
- 零光斑 · 出光均勻柔和
- 高品質表面處理 · 高品質PC擴散面罩
- 型材、面罩長度一致 · 一刀完成切割

適用 2835 120燈/米 9w/ 3000K / 4000K / 6000K / 5mm / CRI>90  
 適用 2835 240燈/米 15w/ 3000K / 4000K / 6000K / 16mm / CRI>90

### ◆ 基本參數 BASIC PARAMETERS

|      |           |
|------|-----------|
| 鋁材質  | AL6063-T5 |
| 表面工藝 | 氧化亞銀處理    |
| 面罩材質 | 白色無光點PC罩  |
| 色號   | RAL9003   |

### ◆ 標準配備 STANDARD ACCESSORIES

| 型材組件 Profile Components |  |
|-------------------------|--|
| 型材                      | L3000*W50*H76 mm  |
| 面罩                      |                   |
| 堵頭*2                    |  |

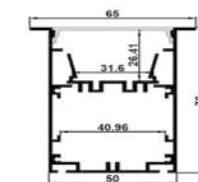
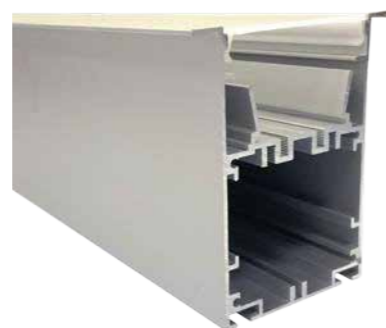

### ◆ 選購配備 OPTIONAL ACCESSORIES

| 安裝配件 Installation Accessories                             |  |
|---|--|
| 安裝卡扣  |  |
| 光源配件 Lighting Source                                      |  |
| 適用 2835 120燈/米 12w/ 3000K / 4000K / 6000K / 5mm / CRI>90  |  |
| 適用 2835 182燈/米 15w/ 3000K / 4000K / 6000K / 10mm / CRI>90 |  |



## SL5090

- 可應用於各種空間設計
- 零光斑 · 出光均勻柔和
- 高品質表面處理 · 高品質PC擴散面罩
- 型材、面罩長度一致 · 一刀完成切割

### ◆ 基本參數 BASIC PARAMETERS

|      |           |
|------|-----------|
| 鋁材質  | AL6063-T5 |
| 表面工藝 | 氧化亞銀處理    |
| 面罩材質 | 白色無光點PC罩  |
| 色號   | RAL9003   |

### ◆ 標準配備 STANDARD ACCESSORIES

| 型材組件 Profile Components |  |
|-------------------------|--|
| 型材                      | L3000*W50*H90 mm  |
| 面罩                      |                   |
| 堵頭*2                    |  |

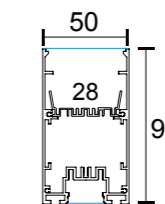

### ◆ 選購配備 OPTIONAL ACCESSORIES

| 安裝配件 Installation Accessories                             |  |
|---|--|
| 安裝卡扣  |  |
| 光源配件 Lighting Source                                      |  |
| 適用 2835 120燈/米 12w/ 3000K / 4000K / 6000K / 5mm / CRI>90  |  |
| 適用 2835 182燈/米 15w/ 3000K / 4000K / 6000K / 10mm / CRI>90 |  |

## SL5585

- 可應用於各種空間
- 零光斑 · 出光均勻柔和
- 高品質表面處理 · 高品質PC擴散面罩
- 型材、面罩長度一致 · 一刀完成切割

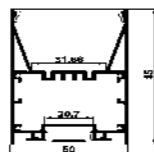

### ◆ 基本參數 BASIC PARAMETERS

|      |           |
|------|-----------|
| 鋁材質  | AL6063-T5 |
| 表面工藝 | 氧化亞銀處理    |
| 面罩材質 | 白色無光點PC罩  |
| 色號   | RAL9003   |

### ◆ 標準配備 STANDARD ACCESSORIES

#### 型材組件 Profile Components

|      |                  |  |
|------|------------------|--|
| 型材   | L3000*W50*H85 mm |  |
| 面罩   |                  |  |
| 堵頭*2 |                  |  |

### ◆ 選購配備 OPTIONAL ACCESSORIES

#### 安裝配件 Installation Accessories



#### 光源配件 Lighting Source

適用 2835 120燈/米 12w/ 3000K / 4000K / 6000K / 5mm / CRI>90  
 適用 2835 182燈/米 15w/ 3000K / 4000K / 6000K / 10mm / CRI>90

## SL5550

- 可應用於各種空間
- 零光斑 · 出光均勻柔和
- 高品質表面處理 · 高品質PC擴散面罩
- 型材、面罩長度一致 · 一刀完成切割

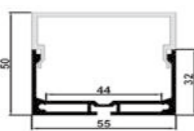

### ◆ 基本參數 BASIC PARAMETERS

|      |           |
|------|-----------|
| 鋁材質  | AL6063-T5 |
| 表面工藝 | 氧化亞銀處理    |
| 面罩材質 | 白色無光點PC罩  |
| 色號   | RAL9003   |

### ◆ 標準配備 STANDARD ACCESSORIES

#### 型材組件 Profile Components

|      |                  |  |
|------|------------------|--|
| 型材   | L3000*W55*H50 mm |  |
| 面罩   |                  |  |
| 堵頭*2 |                  |  |

### ◆ 選購配備 OPTIONAL ACCESSORIES

#### 安裝配件 Installation Accessories



#### 光源配件 Lighting Source

適用 2835 120燈/米 12w/ 3000K / 4000K / 6000K / 5mm / CRI>90  
 適用 2835 182燈/米 15w/ 3000K / 4000K / 6000K / 10mm / CRI>90

## SL5532

- 可應用於各種空間
- 零光斑 · 出光均勻柔和
- 高品質表面處理 · 高品質PC擴散面罩
- 型材、面罩長度一致 · 一刀完成切割

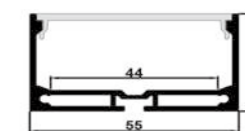

### ◆ 基本參數 BASIC PARAMETERS

|      |           |
|------|-----------|
| 鋁材質  | AL6063-T5 |
| 表面工藝 | 氧化亞銀處理    |
| 面罩材質 | 白色無光點PC罩  |
| 色號   | RAL9003   |

### ◆ 標準配備 STANDARD ACCESSORIES

#### 型材組件 Profile Components

|      |                  |  |
|------|------------------|--|
| 型材   | L3000*W50*H32 mm |  |
| 面罩   |                  |  |
| 堵頭*2 |                  |  |

### ◆ 選購配備 OPTIONAL ACCESSORIES

#### 安裝配件 Installation Accessories



#### 光源配件 Lighting Source

適用 2835 120燈/米 12w/ 3000K / 4000K / 6000K / 5mm / CRI>90  
 適用 2835 182燈/米 15w/ 3000K / 4000K / 6000K / 10mm / CRI>90



## SL60

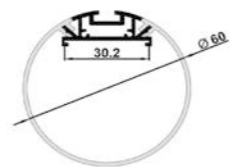

- 可應用於各種空間
- 零光斑，出光均勻柔和
- 高品質表面處理，高品質PC擴散面罩
- 型材、面罩長度一致，一刀完成切割



### ◆ 基本參數 BASIC PARAMETERS

|      |           |
|------|-----------|
| 鋁材質  | AL6063-T5 |
| 表面工藝 | 氧化亞銀處理    |
| 面罩材質 | 白色無光點PC罩  |
| 色號   | RAL9003   |

### ◆ 標準配備 STANDARD ACCESSORIES

| 型材組件 Profile Components |  |
|-------------------------|--|
| 型材                      | L3000*W60 mm  |
| 面罩                      |               |
| 堵頭*2                    |  |

### ◆ 選購配備 OPTIONAL ACCESSORIES

| 安裝配件 Installation Accessories                             |  |
|---|--|
| 安裝卡扣  |  |
| 光源配件 Lighting Source                                      |  |
| 適用 2835 120燈/米 12w/ 3000K / 4000K / 6000K / 5mm / CRI>90  |  |
| 適用 2835 182燈/米 15w/ 3000K / 4000K / 6000K / 10mm / CRI>90 |  |

## SL7635A

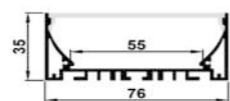

- 可應用於各種空間
- 零光斑，出光均勻柔和
- 高品質表面處理，高品質PC擴散面罩
- 型材、面罩長度一致，一刀完成切割



### ◆ 基本參數 BASIC PARAMETERS

|      |           |
|------|-----------|
| 鋁材質  | AL6063-T5 |
| 表面工藝 | 氧化亞銀處理    |
| 面罩材質 | 白色無光點PC罩  |
| 色號   | RAL9003   |

### ◆ 標準配備 STANDARD ACCESSORIES

| 型材組件 Profile Components |  |
|-------------------------|--|
| 型材                      | L3000*W76*H35 mm  |
| 面罩                      |                   |
| 堵頭*2                    |  |

### ◆ 選購配備 OPTIONAL ACCESSORIES

| 安裝配件 Installation Accessories                             |  |
|---|--|
| 安裝卡扣  |  |
| 光源配件 Lighting Source                                      |  |
| 適用 2835 120燈/米 12w/ 3000K / 4000K / 6000K / 5mm / CRI>90  |  |
| 適用 2835 182燈/米 15w/ 3000K / 4000K / 6000K / 10mm / CRI>90 |  |

## SL120

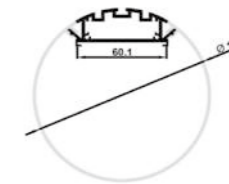

- 可應用於各種空間
- 零光斑，出光均勻柔和
- 高品質表面處理，高品質PC擴散面罩
- 型材、面罩長度一致，一刀完成切割



### ◆ 基本參數 BASIC PARAMETERS

|      |           |
|------|-----------|
| 鋁材質  | AL6063-T5 |
| 表面工藝 | 氧化亞銀處理    |
| 面罩材質 | 白色無光點PC罩  |
| 色號   | RAL9003   |

### ◆ 標準配備 STANDARD ACCESSORIES

| 型材組件 Profile Components |   |
|-------------------------|---|
| 型材                      | L3000*W120 mm  |
| 面罩                      |                |
| 堵頭*2                    |   |

### ◆ 選購配備 OPTIONAL ACCESSORIES

| 安裝配件 Installation Accessories                             |   |
|---|---|
| 安裝卡扣  |  |
| 光源配件 Lighting Source                                      |   |
| 適用 2835 120燈/米 12w/ 3000K / 4000K / 6000K / 5mm / CRI>90  |   |
| 適用 2835 182燈/米 15w/ 3000K / 4000K / 6000K / 10mm / CRI>90 |   |

## SL7635B

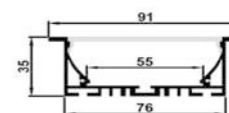

- 可應用於各種空間
- 零光斑，出光均勻柔和
- 高品質表面處理，高品質PC擴散面罩
- 型材、面罩長度一致，一刀完成切割



### ◆ 基本參數 BASIC PARAMETERS

|      |           |
|------|-----------|
| 鋁材質  | AL6063-T5 |
| 表面工藝 | 氧化亞銀處理    |
| 面罩材質 | 白色無光點PC罩  |
| 色號   | RAL9003   |

### ◆ 標準配備 STANDARD ACCESSORIES

| 型材組件 Profile Components |  |
|-------------------------|--|
| 型材                      | L3000*W76*H35 mm  |
| 面罩                      |                   |
| 堵頭*2                    |  |

### ◆ 選購配備 OPTIONAL ACCESSORIES

| 安裝配件 Installation Accessories                             |   |
|---|---|
| 安裝卡扣  |  |
| 光源配件 Lighting Source                                      |   |
| 適用 2835 120燈/米 12w/ 3000K / 4000K / 6000K / 5mm / CRI>90  |   |
| 適用 2835 182燈/米 15w/ 3000K / 4000K / 6000K / 10mm / CRI>90 |   |

## SL7676A

- 可應用於各種狹小空間
- 零光斑，出光均勻柔和
- 高品質表面處理，高品質PC擴散面罩
- 型材、面罩長度一致，一刀完成切割

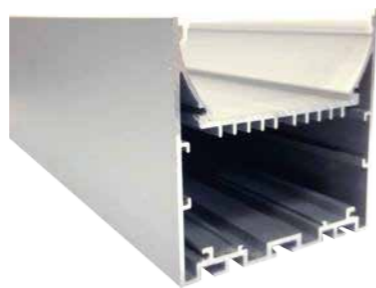

## ◆ 基本參數 BASIC PARAMETERS

|      |           |
|------|-----------|
| 鋁材質  | AL6063-T5 |
| 表面工藝 | 氧化亞銀處理    |
| 面罩材質 | 白色無光點PC罩  |
| 色號   | RAL9003   |

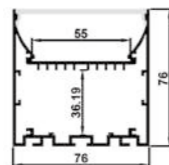

## ◆ 標準配備 STANDARD ACCESSORIES

## 型材組件 Profile Components

|    |                  |
|----|------------------|
| 型材 | L3000*W76*H76 mm |
|----|------------------|



面罩



堵頭\*2

## ◆ 選購配備 OPTIONAL ACCESSORIES

## 安裝配件 Installation Accessories

安裝卡扣

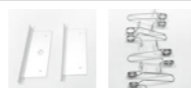

## 光源配件 Lighting Source

適用 2835 120燈/米 12w/ 3000K / 4000K / 6000K / 5mm / CRI>90  
 適用 2835 182燈/米 15w/ 3000K / 4000K / 6000K / 10mm / CRI>90

## SL8035A

- 可應用於各種空間
- 零光斑，出光均勻柔和
- 高品質表面處理，高品質PC擴散面罩
- 型材、面罩長度一致，一刀完成切割



## ◆ 基本參數 BASIC PARAMETERS

|      |           |
|------|-----------|
| 鋁材質  | AL6063-T5 |
| 表面工藝 | 氧化亞銀處理    |
| 面罩材質 | 白色無光點PC罩  |
| 色號   | RAL9003   |

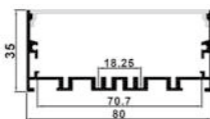

## ◆ 標準配備 STANDARD ACCESSORIES

## 型材組件 Profile Components

|    |                  |
|----|------------------|
| 型材 | L3000*W80*H35 mm |
|----|------------------|



面罩



堵頭\*2

## ◆ 選購配備 OPTIONAL ACCESSORIES

## 安裝配件 Installation Accessories

安裝卡扣



## 光源配件 Lighting Source

適用 2835 120燈/米 12w/ 3000K / 4000K / 6000K / 5mm / CRI>90  
 適用 2835 182燈/米 15w/ 3000K / 4000K / 6000K / 10mm / CRI>90

## SL7676B

- 可應用於各種狹小空間
- 零光斑，出光均勻柔和
- 高品質表面處理，高品質PC擴散面罩
- 型材、面罩長度一致，一刀完成切割

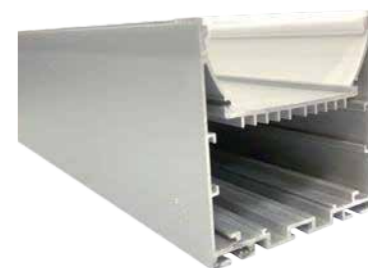

## ◆ 基本參數 BASIC PARAMETERS

|      |           |
|------|-----------|
| 鋁材質  | AL6063-T5 |
| 表面工藝 | 氧化亞銀處理    |
| 面罩材質 | 白色無光點PC罩  |
| 色號   | RAL9003   |

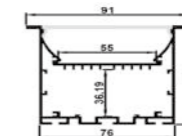

## ◆ 標準配備 STANDARD ACCESSORIES

## 型材組件 Profile Components

|    |                  |
|----|------------------|
| 型材 | L3000*W76*H76 mm |
|----|------------------|



面罩



堵頭\*2

## ◆ 選購配備 OPTIONAL ACCESSORIES

## 安裝配件 Installation Accessories

安裝卡扣



## 光源配件 Lighting Source

適用 2835 120燈/米 12w/ 3000K / 4000K / 6000K / 5mm / CRI>90  
 適用 2835 182燈/米 15w/ 3000K / 4000K / 6000K / 10mm / CRI>90

## SL8035B

- 可應用於各種空間
- 零光斑，出光均勻柔和
- 高品質表面處理，高品質PC擴散面罩
- 型材、面罩長度一致，一刀完成切割



## ◆ 基本參數 BASIC PARAMETERS

|      |           |
|------|-----------|
| 鋁材質  | AL6063-T5 |
| 表面工藝 | 氧化亞銀處理    |
| 面罩材質 | 白色無光點PC罩  |
| 色號   | RAL9003   |

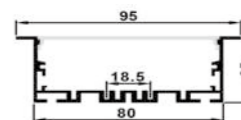

## ◆ 標準配備 STANDARD ACCESSORIES

## 型材組件 Profile Components

|    |                  |
|----|------------------|
| 型材 | L3000*W80*H35 mm |
|----|------------------|



面罩



堵頭\*2

## ◆ 選購配備 OPTIONAL ACCESSORIES

## 安裝配件 Installation Accessories

安裝卡扣



## 光源配件 Lighting Source

適用 2835 120燈/米 12w/ 3000K / 4000K / 6000K / 5mm / CRI>90  
 適用 2835 182燈/米 15w/ 3000K / 4000K / 6000K / 10mm / CRI>90



## SL8080

- 可應用於各種狹小空間
- 零光斑，出光均勻柔和
- 高品質表面處理，高品質PC擴散面罩
- 型材、面罩長度一致，一刀完成切割



### ◆ 基本參數 BASIC PARAMETERS

|      |           |
|------|-----------|
| 鋁材質  | AL6063-T5 |
| 表面工藝 | 氧化亞銀處理    |
| 面罩材質 | 白色無光點PC罩  |
| 色號   | RAL9003   |

### ◆ 標準配備 STANDARD ACCESSORIES

#### 型材組件 Profile Components

|    |                  |
|----|------------------|
| 型材 | L3000*W80*H80 mm |
|----|------------------|

面罩

堵頭\*2

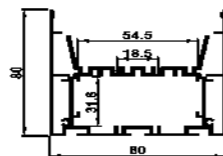

### ◆ 選購配備 OPTIONAL ACCESSORIES

#### 安裝配件 Installation Accessories

安裝卡扣



#### 光源配件 Lighting Source

適用 2835 120燈/米 12w/ 3000K / 4000K / 6000K / 5mm / CRI>90  
適用 2835 182燈/米 15w/ 3000K / 4000K / 6000K / 10mm / CRI>90

## SL9358

- 可應用於各種空間
- 零光斑，出光均勻柔和
- 高品質表面處理，高品質PC擴散面罩
- 型材、面罩長度一致，一刀完成切割



### ◆ 基本參數 BASIC PARAMETERS

|      |           |
|------|-----------|
| 鋁材質  | AL6063-T5 |
| 表面工藝 | 氧化亞銀處理    |
| 面罩材質 | 白色無光點PC罩  |
| 色號   | RAL9003   |

### ◆ 標準配備 STANDARD ACCESSORIES

#### 型材組件 Profile Components

|    |                        |
|----|------------------------|
| 型材 | L3000*W93.13*H58.55 mm |
|----|------------------------|

面罩

堵頭\*2

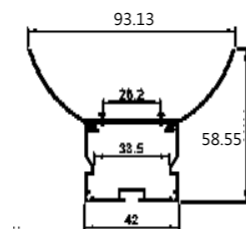

### ◆ 選購配備 OPTIONAL ACCESSORIES

#### 安裝配件 Installation Accessories

安裝卡扣



#### 光源配件 Lighting Source

適用 2835 120燈/米 12w/ 3000K / 4000K / 6000K / 5mm / CRI>90  
適用 2835 182燈/米 15w/ 3000K / 4000K / 6000K / 10mm / CRI>90

## SL10235A

- 可應用於各種狹小空間
- 零光斑，出光均勻柔和
- 高品質表面處理，高品質PC擴散面罩
- 型材、面罩長度一致，一刀完成切割



### ◆ 基本參數 BASIC PARAMETERS

|      |           |
|------|-----------|
| 鋁材質  | AL6063-T5 |
| 表面工藝 | 氧化亞銀處理    |
| 面罩材質 | 白色無光點PC罩  |
| 色號   | RAL9003   |

### ◆ 標準配備 STANDARD ACCESSORIES

#### 型材組件 Profile Components

|    |                   |
|----|-------------------|
| 型材 | L3000*W102*H35 mm |
|----|-------------------|

面罩

堵頭\*2

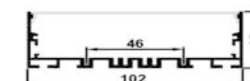

### ◆ 選購配備 OPTIONAL ACCESSORIES

#### 安裝配件 Installation Accessories

安裝卡扣



#### 光源配件 Lighting Source

適用 2835 120燈/米 12w/ 3000K / 4000K / 6000K / 5mm / CRI>90  
適用 2835 182燈/米 15w/ 3000K / 4000K / 6000K / 10mm / CRI>90

## SL10235B

- 可應用於各種空間
- 零光斑，出光均勻柔和
- 高品質表面處理，高品質PC擴散面罩
- 型材、面罩長度一致，一刀完成切割



### ◆ 基本參數 BASIC PARAMETERS

|      |           |
|------|-----------|
| 鋁材質  | AL6063-T5 |
| 表面工藝 | 氧化亞銀處理    |
| 面罩材質 | 白色無光點PC罩  |
| 色號   | RAL9003   |

### ◆ 標準配備 STANDARD ACCESSORIES

#### 型材組件 Profile Components

|    |                   |
|----|-------------------|
| 型材 | L3000*W102*H35 mm |
|----|-------------------|

面罩

堵頭\*2

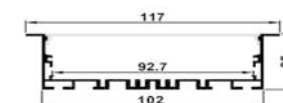

### ◆ 選購配備 OPTIONAL ACCESSORIES

#### 安裝配件 Installation Accessories

安裝卡扣



#### 光源配件 Lighting Source

適用 2835 120燈/米 12w/ 3000K / 4000K / 6000K / 5mm / CRI>90  
適用 2835 182燈/米 15w/ 3000K / 4000K / 6000K / 10mm / CRI>90

## SL10280

- 可應用於各種空間
- 零光斑，出光均勻柔和
- 高品質表面處理，高品質PC擴散面罩
- 型材、面罩長度一致，一刀完成切割

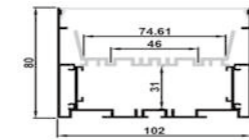
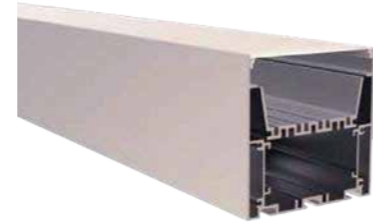

### ◆ 基本參數 BASIC PARAMETERS

|      |           |
|------|-----------|
| 鋁材質  | AL6063-T5 |
| 表面工藝 | 氧化亞銀處理    |
| 面罩材質 | 白色無光點PC罩  |
| 色號   | RAL9003   |

### ◆ 標準配備 STANDARD ACCESSORIES

#### 型材組件 Profile Components

型材 L3000\*W102\*H80 mm



面罩



堵頭\*2

### ◆ 選購配備 OPTIONAL ACCESSORIES

#### 安裝配件 Installation Accessories

安裝卡扣



#### 光源配件 Lighting Source

適用 2835 120燈/米 12w/ 3000K / 4000K / 6000K / 5mm / CRI>90  
適用 2835 182燈/米 15w/ 3000K / 4000K / 6000K / 10mm / CRI>90



## SL14232

- 可應用於各種空間
- 零光斑，出光均勻柔和
- 高品質表面處理，高品質PC擴散面罩
- 型材、面罩長度一致，一刀完成切割

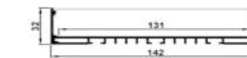

### ◆ 基本參數 BASIC PARAMETERS

|      |           |
|------|-----------|
| 鋁材質  | AL6063-T5 |
| 表面工藝 | 氧化亞銀處理    |
| 面罩材質 | 白色無光點PC罩  |
| 色號   | RAL9003   |

### ◆ 標準配備 STANDARD ACCESSORIES

#### 型材組件 Profile Components

型材 L3000\*W142\*H32 mm



面罩



堵頭\*2

### ◆ 選購配備 OPTIONAL ACCESSORIES

#### 安裝配件 Installation Accessories

安裝卡扣



#### 光源配件 Lighting Source

適用 2835 120燈/米 12w/ 3000K / 4000K / 6000K / 5mm / CRI>90  
適用 2835 182燈/米 15w/ 3000K / 4000K / 6000K / 10mm / CRI>90



## SL-Y1009

- 可應用於各種間照設計
- 零光斑，出光均勻柔和
- 高品質表面處理，高品質PC擴散面罩
- 型材、面罩長度一致，一刀完成切割

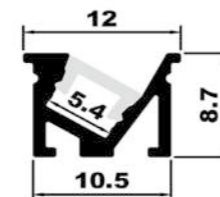

### ◆ 基本參數 BASIC PARAMETERS

|      |           |
|------|-----------|
| 鋁材質  | AL6063-T5 |
| 表面工藝 | 氧化亞銀處理    |
| 面罩材質 | 白色無光點PC罩  |
| 色號   | RAL9003   |

### ◆ 標準配備 STANDARD ACCESSORIES

#### 型材組件 Profile Components

型材 L3000\*W10.5\*H8.7mm



面罩



堵頭\*2

### ◆ 選購配備 OPTIONAL ACCESSORIES

#### 安裝配件 Installation Accessories

安裝卡扣



#### 光源配件 Lighting Source

適用 2835 120燈/米 12w/ 3000K / 4000K / 6000K / 5mm / CRI>90  
適用 2835 182燈/米 15w/ 3000K / 4000K / 6000K / 10mm / CRI>90



## SL-Y1911A

- 可應用於各種間照設計
- 零光斑 · 出光均勻柔和
- 高品質表面處理 · 高品質PC擴散面罩
- 型材、面罩長度一致 · 一刀完成切割

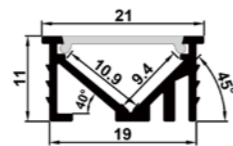

## ◆ 基本參數 BASIC PARAMETERS

|      |           |
|------|-----------|
| 鋁材質  | AL6063-T5 |
| 表面工藝 | 氧化亞銀處理    |
| 面罩材質 | 白色無光點PC罩  |
| 色號   | RAL9003   |

## ◆ 標準配備 STANDARD ACCESSORIES

## 型材組件 Profile Components

|    |                 |
|----|-----------------|
| 型材 | L3000*W19*H11mm |
|----|-----------------|



面罩



堵頭\*2

## ◆ 選購配備 OPTIONAL ACCESSORIES

## 安裝配件 Installation Accessories

安裝卡扣



## 光源配件 Lighting Source

適用 2835 120燈/米 12w/ 3000K / 4000K / 6000K / 5mm / CRI>90  
 適用 2835 182燈/米 15w/ 3000K / 4000K / 6000K / 10mm / CRI>90

## SL-Y1911B

- 可應用於各種間照設計
- 零光斑 · 出光均勻柔和
- 高品質表面處理 · 高品質PC擴散面罩
- 型材、面罩長度一致 · 一刀完成切割

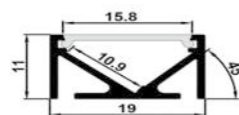

## ◆ 基本參數 BASIC PARAMETERS

|      |           |
|------|-----------|
| 鋁材質  | AL6063-T5 |
| 表面工藝 | 氧化亞銀處理    |
| 面罩材質 | 白色無光點PC罩  |
| 色號   | RAL9003   |

## ◆ 標準配備 STANDARD ACCESSORIES

## 型材組件 Profile Components

|    |                 |
|----|-----------------|
| 型材 | L3000*W19*H11mm |
|----|-----------------|



面罩



堵頭\*2

## ◆ 選購配備 OPTIONAL ACCESSORIES

## 安裝配件 Installation Accessories

安裝卡扣



## 光源配件 Lighting Source

適用 2835 120燈/米 12w/ 3000K / 4000K / 6000K / 5mm / CRI>90  
 適用 2835 182燈/米 15w/ 3000K / 4000K / 6000K / 10mm / CRI>90

## SL-Y2109

- 可應用於各種間照設計
- 零光斑 · 出光均勻柔和
- 高品質表面處理 · 高品質PC擴散面罩
- 型材、面罩長度一致 · 一刀完成切割

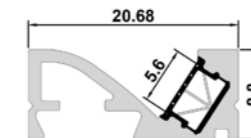

## ◆ 基本參數 BASIC PARAMETERS

|      |           |
|------|-----------|
| 鋁材質  | AL6063-T5 |
| 表面工藝 | 氧化亞銀處理    |
| 面罩材質 | 白色無光點PC罩  |
| 色號   | RAL9003   |

## ◆ 標準配備 STANDARD ACCESSORIES

## 型材組件 Profile Components

|    |                      |
|----|----------------------|
| 型材 | L3000*W20.68*H8.8 mm |
|----|----------------------|



面罩



堵頭\*2

## ◆ 選購配備 OPTIONAL ACCESSORIES

## 安裝配件 Installation Accessories

安裝卡扣

## 光源配件 Lighting Source

適用 COB 6W/ 3000K / 4000K / 6000K / 4mm / CRI>90

## SL-Y2212

- 可應用於各種間照設計
- 零光斑 · 出光均勻柔和
- 高品質表面處理 · 高品質PC擴散面罩
- 型材、面罩長度一致 · 一刀完成切割

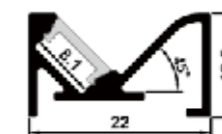

## ◆ 基本參數 BASIC PARAMETERS

|      |           |
|------|-----------|
| 鋁材質  | AL6063-T5 |
| 表面工藝 | 氧化亞銀處理    |
| 面罩材質 | 白色無光點PC罩  |
| 色號   | RAL9003   |

## ◆ 標準配備 STANDARD ACCESSORIES

## 型材組件 Profile Components

|    |                    |
|----|--------------------|
| 型材 | L3000*W22*H12.5 mm |
|----|--------------------|



面罩



堵頭\*2

## ◆ 選購配備 OPTIONAL ACCESSORIES

## 安裝配件 Installation Accessories

安裝卡扣



## 光源配件 Lighting Source

適用 2835 120燈/米 12w/ 3000K / 4000K / 6000K / 5mm / CRI>90  
 適用 2835 182燈/米 15w/ 3000K / 4000K / 6000K / 10mm / CRI>90

## SL-Y2210

- 可應用於各種間照設計
- 零光斑 · 出光均勻柔和
- 高品質表面處理 · 高品質PC擴散面罩
- 型材、面罩長度一致 · 一刀完成切割

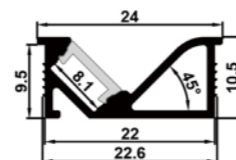

### ◆ 基本參數 BASIC PARAMETERS

|      |           |
|------|-----------|
| 鋁材質  | AL6063-T5 |
| 表面工藝 | 氧化亞銀處理    |
| 面罩材質 | 白色無光點PC罩  |
| 色號   | RAL9003   |

### ◆ 標準配備 STANDARD ACCESSORIES

#### 型材組件 Profile Components

|      |                      |  |
|------|----------------------|--|
| 型材   | L3000*W22.6*H10.5 mm |  |
| 面罩   |                      |  |
| 堵頭*2 |                      |  |

### ◆ 選購配備 OPTIONAL ACCESSORIES

#### 安裝配件 Installation Accessories

安裝卡扣



#### 光源配件 Lighting Source

適用 2835 120燈/米 12w/ 3000K / 4000K / 6000K / 5mm / CRI>90

## SL-Y2219

- 可應用於各種間照設計
- 零光斑 · 出光均勻柔和
- 高品質表面處理 · 高品質PC擴散面罩
- 型材、面罩長度一致 · 一刀完成切割

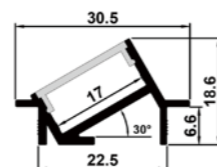

### ◆ 基本參數 BASIC PARAMETERS

|      |           |
|------|-----------|
| 鋁材質  | AL6063-T5 |
| 表面工藝 | 氧化亞銀處理    |
| 面罩材質 | 白色無光點PC罩  |
| 色號   | RAL9003   |

### ◆ 標準配備 STANDARD ACCESSORIES

#### 型材組件 Profile Components

|      |                      |  |
|------|----------------------|--|
| 型材   | L3000*W22.5*H18.6 mm |  |
| 面罩   |                      |  |
| 堵頭*2 |                      |  |

### ◆ 選購配備 OPTIONAL ACCESSORIES

#### 安裝配件 Installation Accessories

安裝卡扣

#### 光源配件 Lighting Source

適用 2835 120燈/米 12w/ 3000K / 4000K / 6000K / 5mm / CRI>90  
適用 2835 182燈/米 15w/ 3000K / 4000K / 6000K / 10mm / CRI>90

## SL-C0808

- 可應用於各種間照設計
- 零光斑 · 出光均勻柔和
- 高品質表面處理 · 高品質PC擴散面罩
- 型材、面罩長度一致 · 一刀完成切割

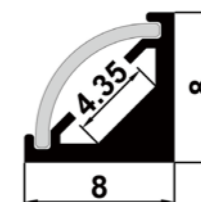

### ◆ 基本參數 BASIC PARAMETERS

|      |           |
|------|-----------|
| 鋁材質  | AL6063-T5 |
| 表面工藝 | 氧化亞銀處理    |
| 面罩材質 | 白色無光點PC罩  |
| 色號   | RAL9003   |

### ◆ 標準配備 STANDARD ACCESSORIES

#### 型材組件 Profile Components

|      |                |  |
|------|----------------|--|
| 型材   | L3000*W8*H8 mm |  |
| 面罩   |                |  |
| 堵頭*2 |                |  |

### ◆ 選購配備 OPTIONAL ACCESSORIES

#### 安裝配件 Installation Accessories

安裝卡扣



#### 光源配件 Lighting Source

適用 2835 120燈/米 12w/ 3000K / 4000K / 6000K / 5mm / CRI>90

## SL-C1313

- 可應用於各種間照設計
- 零光斑 · 出光均勻柔和
- 高品質表面處理 · 高品質PC擴散面罩
- 型材、面罩長度一致 · 一刀完成切割



### ◆ 基本參數 BASIC PARAMETERS

|      |           |
|------|-----------|
| 鋁材質  | AL6063-T5 |
| 表面工藝 | 氧化亞銀處理    |
| 面罩材質 | 白色無光點PC罩  |
| 色號   | RAL9003   |

### ◆ 標準配備 STANDARD ACCESSORIES

#### 型材組件 Profile Components

|      |                  |  |
|------|------------------|--|
| 型材   | L3000*W13*H13 mm |  |
| 面罩   |                  |  |
| 堵頭*2 |                  |  |

### ◆ 選購配備 OPTIONAL ACCESSORIES

#### 安裝配件 Installation Accessories

安裝卡扣



#### 光源配件 Lighting Source

適用 2835 5W/ 3000K / 4000K / 6000K / 5mm / CRI>90

## SL-C1616R

- 可應用於各種間照設計
- 零光斑，出光均勻柔和
- 高品質表面處理，高品質PC擴散面罩
- 型材、面罩長度一致，一刀完成切割

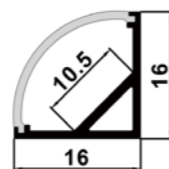



### ◆ 基本參數 BASIC PARAMETERS

|      |           |
|------|-----------|
| 鋁材質  | AL6063-T5 |
| 表面工藝 | 氧化亞銀處理    |
| 面罩材質 | 白色無光點PC罩  |
| 色號   | RAL9003   |

### ◆ 標準配備 STANDARD ACCESSORIES

#### 型材組件 Profile Components

|      |                  |   |
|------|------------------|---|
| 型材   | L3000*W16*H16 mm |  |
| 面罩   |                  |  |
| 堵頭*2 |                  |  |

### ◆ 選購配備 OPTIONAL ACCESSORIES

#### 安裝配件 Installation Accessories



#### 光源配件 Lighting Source

適用 2835 12W/ 3000K / 4000K / 6000K / 5mm / CRI>90

## SL-C3030R

- 可應用於各種間照設計
- 零光斑，出光均勻柔和
- 高品質表面處理，高品質PC擴散面罩
- 型材、面罩長度一致，一刀完成切割

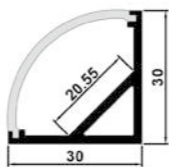



### ◆ 基本參數 BASIC PARAMETERS

|      |           |
|------|-----------|
| 鋁材質  | AL6063-T5 |
| 表面工藝 | 氧化亞銀處理    |
| 面罩材質 | 白色無光點PC罩  |
| 色號   | RAL9003   |

### ◆ 標準配備 STANDARD ACCESSORIES

#### 型材組件 Profile Components

|      |                  |   |
|------|------------------|---|
| 型材   | L3000*W30*H30 mm |  |
| 面罩   |                  |  |
| 堵頭*2 |                  |  |

### ◆ 選購配備 OPTIONAL ACCESSORIES

#### 安裝配件 Installation Accessories



#### 光源配件 Lighting Source

適用 2835 120燈/米 12w/ 3000K / 4000K / 6000K / 8mm / CRI>90  
適用 2835 240燈/米 24w/ 3000K / 4000K / 6000K / 10mm / CRI>90

## SL-C1616

- 可應用於各種間照設計
- 零光斑，出光均勻柔和
- 高品質表面處理，高品質PC擴散面罩
- 型材、面罩長度一致，一刀完成切割

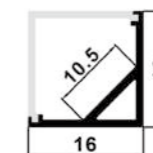
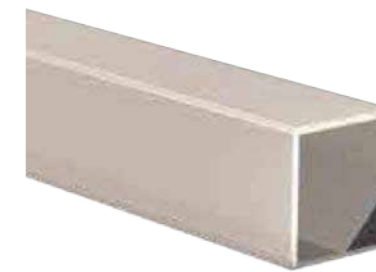



### ◆ 基本參數 BASIC PARAMETERS

|      |           |
|------|-----------|
| 鋁材質  | AL6063-T5 |
| 表面工藝 | 氧化亞銀處理    |
| 面罩材質 | 白色無光點PC罩  |
| 色號   | RAL9003   |

### ◆ 標準配備 STANDARD ACCESSORIES

#### 型材組件 Profile Components

|      |                  |   |
|------|------------------|---|
| 型材   | L3000*W16*H16 mm |  |
| 面罩   |                  |  |
| 堵頭*2 |                  |  |

### ◆ 選購配備 OPTIONAL ACCESSORIES

#### 安裝配件 Installation Accessories



#### 光源配件 Lighting Source

適用 2835 120燈/米 12w/ 3000K / 4000K / 6000K / 8mm / CRI>90

## SL-C3030

- 可應用於各種間照設計
- 零光斑，出光均勻柔和
- 高品質表面處理，高品質PC擴散面罩
- 型材、面罩長度一致，一刀完成切割

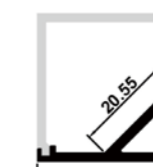



### ◆ 基本參數 BASIC PARAMETERS

|      |           |
|------|-----------|
| 鋁材質  | AL6063-T5 |
| 表面工藝 | 氧化亞銀處理    |
| 面罩材質 | 白色無光點PC罩  |
| 色號   | RAL9003   |

### ◆ 標準配備 STANDARD ACCESSORIES

#### 型材組件 Profile Components

|      |                  |   |
|------|------------------|---|
| 型材   | L3000*W30*H30 mm |  |
| 面罩   |                  |  |
| 堵頭*2 |                  |  |

### ◆ 選購配備 OPTIONAL ACCESSORIES

#### 安裝配件 Installation Accessories



#### 光源配件 Lighting Source

適用 2835 120燈/米 12w/ 3000K / 4000K / 6000K / 8mm / CRI>90  
適用 2835 240燈/米 24w/ 3000K / 4000K / 6000K / 10mm / CRI>90

## SL-C1818

- 可應用於各種間照設計
- 零光斑，出光均勻柔和
- 高品質表面處理，高品質PC擴散面罩
- 型材、面罩長度一致，一刀完成切割

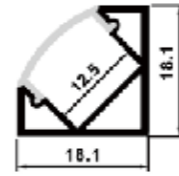

### ◆ 基本參數 BASIC PARAMETERS

|      |           |
|------|-----------|
| 鋁材質  | AL6063-T5 |
| 表面工藝 | 氧化亞銀處理    |
| 面罩材質 | 白色無光點PC罩  |
| 色號   | RAL9003   |

### ◆ 標準配備 STANDARD ACCESSORIES

#### 型材組件 Profile Components

|      |                      |  |
|------|----------------------|--|
| 型材   | L2000*W18.1*H18.1 mm |  |
| 面罩   |                      |  |
| 堵頭*2 |                      |  |

### ◆ 選購配備 OPTIONAL ACCESSORIES

#### 安裝配件 Installation Accessories



#### 光源配件 Lighting Source

適用 2835 120燈/米 12w/ 3000K / 4000K / 6000K / 8mm / CRI>90  
 適用 2835 240燈/米 24w/ 3000K / 4000K / 6000K / 10mm / CRI>90

## SL-B3511

- 可應用於各種間照設計
- 零光斑，出光均勻柔和
- 高品質表面處理，高品質PC擴散面罩
- 型材、面罩長度一致，一刀完成切割

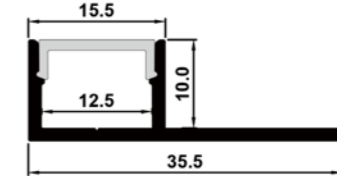

### ◆ 基本參數 BASIC PARAMETERS

|      |           |
|------|-----------|
| 鋁材質  | AL6063-T5 |
| 表面工藝 | 氧化亞銀處理    |
| 面罩材質 | 白色無光點PC罩  |
| 色號   | RAL9003   |

### ◆ 標準配備 STANDARD ACCESSORIES

#### 型材組件 Profile Components

|      |                    |  |
|------|--------------------|--|
| 型材   | L3000*W35.5*H10 mm |  |
| 面罩   |                    |  |
| 堵頭*2 |                    |  |

### ◆ 選購配備 OPTIONAL ACCESSORIES

#### 安裝配件 Installation Accessories

安裝卡扣

#### 光源配件 Lighting Source

適用 2835 120燈/米 12w/ 3000K / 4000K / 6000K / 8mm / CRI>90  
 適用 2835 240燈/米 24w/ 3000K / 4000K / 6000K / 10mm / CRI>90

## SL-B4615

- 可應用於各種間照設計
- 零光斑，出光均勻柔和
- 高品質表面處理，高品質PC擴散面罩
- 型材、面罩長度一致，一刀完成切割

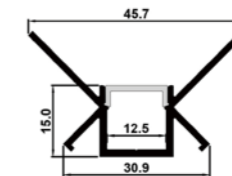
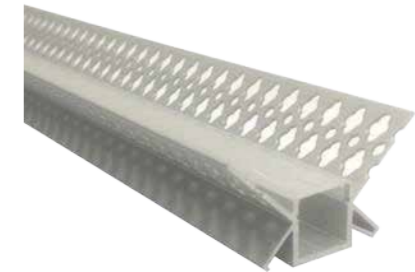

### ◆ 基本參數 BASIC PARAMETERS

|      |           |
|------|-----------|
| 鋁材質  | AL6063-T5 |
| 表面工藝 | 氧化亞銀處理    |
| 面罩材質 | 白色無光點PC罩  |
| 色號   | RAL9003   |

### ◆ 標準配備 STANDARD ACCESSORIES

#### 型材組件 Profile Components

|      |                    |  |
|------|--------------------|--|
| 型材   | L3000*W45.7*H15 mm |  |
| 面罩   |                    |  |
| 堵頭*2 |                    |  |

### ◆ 選購配備 OPTIONAL ACCESSORIES

#### 安裝配件 Installation Accessories

安裝卡扣

#### 光源配件 Lighting Source

適用 2835 120燈/米 12w/ 3000K / 4000K / 6000K / 8mm / CRI>90  
 適用 2835 240燈/米 24w/ 3000K / 4000K / 6000K / 10mm / CRI>90

## SL-B4128



- 可應用於各種間照設計
- 零光斑，出光均勻柔和
- 高品質表面處理，高品質PC擴散面罩
- 型材、面罩長度一致，一刀完成切割

### ◆ 基本參數 BASIC PARAMETERS

|      |           |
|------|-----------|
| 鋁材質  | AL6063-T5 |
| 表面工藝 | 氧化亞銀處理    |
| 面罩材質 | 白色無光點PC罩  |
| 色號   | RAL9003   |

### ◆ 標準配備 STANDARD ACCESSORIES

#### 型材組件 Profile Components

|      |                       |   |
|------|-----------------------|---|
| 型材   | L3000*W40.47*H27.7 mm |  |
| 面罩   |                       |  |
| 堵頭*2 |                       |  |

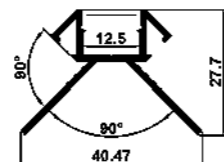
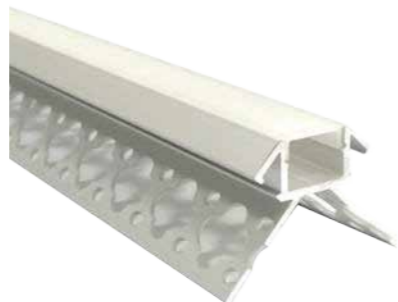

### ◆ 選購配備 OPTIONAL ACCESSORIES

#### 安裝配件 Installation Accessories

安裝卡扣

#### 光源配件 Lighting Source

適用 2835 120燈/米 12w/ 3000K / 4000K / 6000K / 8mm / CRI>90  
適用 2835 240燈/米 24w/ 3000K / 4000K / 6000K / 10mm / CRI>90



## SL-B5917



- 可應用於各種間照設計
- 零光斑，出光均勻柔和
- 高品質表面處理，高品質PC擴散面罩
- 型材、面罩長度一致，一刀完成切割

### ◆ 基本參數 BASIC PARAMETERS

|      |           |
|------|-----------|
| 鋁材質  | AL6063-T5 |
| 表面工藝 | 氧化亞銀處理    |
| 面罩材質 | 白色無光點PC罩  |
| 色號   | RAL9003   |

### ◆ 標準配備 STANDARD ACCESSORIES

#### 型材組件 Profile Components

|      |                      |   |
|------|----------------------|---|
| 型材   | L3000*W59.2*H16.7 mm |  |
| 面罩   |                      |  |
| 堵頭*2 |                      |  |

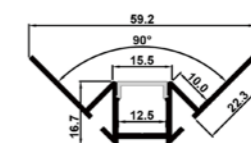

### ◆ 選購配備 OPTIONAL ACCESSORIES

#### 安裝配件 Installation Accessories

安裝卡扣

#### 光源配件 Lighting Source

適用 2835 120燈/米 12w/ 3000K / 4000K / 6000K / 5mm / CRI>90  
適用 2835 182燈/米 15w/ 3000K / 4000K / 6000K / 10mm / CRI>90



## SL-B5315



- 可應用於各種間照設計
- 零光斑，出光均勻柔和
- 高品質表面處理，高品質PC擴散面罩
- 型材、面罩長度一致，一刀完成切割

### ◆ 基本參數 BASIC PARAMETERS

|      |           |
|------|-----------|
| 鋁材質  | AL6063-T5 |
| 表面工藝 | 氧化亞銀處理    |
| 面罩材質 | 白色無光點PC罩  |
| 色號   | RAL9003   |

### ◆ 標準配備 STANDARD ACCESSORIES

#### 型材組件 Profile Components

|      |                      |   |
|------|----------------------|---|
| 型材   | L3000*W53.8*H15.5 mm |  |
| 面罩   |                      |  |
| 堵頭*2 |                      |  |

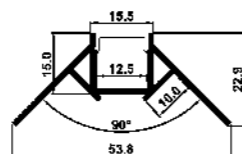

### ◆ 選購配備 OPTIONAL ACCESSORIES

#### 安裝配件 Installation Accessories

安裝卡扣

#### 光源配件 Lighting Source

適用 2835 120燈/米 12w/ 3000K / 4000K / 6000K / 8mm / CRI>90  
適用 2835 240燈/米 24w/ 3000K / 4000K / 6000K / 10mm / CRI>90



## SL-B5615



- 可應用於各種間照設計
- 零光斑，出光均勻柔和
- 高品質表面處理，高品質PC擴散面罩
- 型材、面罩長度一致，一刀完成切割

### ◆ 基本參數 BASIC PARAMETERS

|      |           |
|------|-----------|
| 鋁材質  | AL6063-T5 |
| 表面工藝 | 氧化亞銀處理    |
| 面罩材質 | 白色無光點PC罩  |
| 色號   | RAL9003   |

### ◆ 標準配備 STANDARD ACCESSORIES

#### 型材組件 Profile Components

|      |                    |   |
|------|--------------------|---|
| 型材   | L3000*W55.5*H15 mm |  |
| 面罩   |                    |  |
| 堵頭*2 |                    |  |

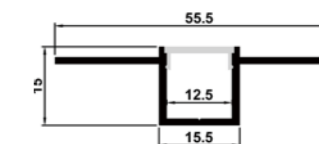

### ◆ 選購配備 OPTIONAL ACCESSORIES

#### 安裝配件 Installation Accessories

安裝卡扣

#### 光源配件 Lighting Source

適用 2835 120燈/米 12w/ 3000K / 4000K / 6000K / 5mm / CRI>90  
適用 2835 182燈/米 15w/ 3000K / 4000K / 6000K / 10mm / CRI>90



## SL-B6010

- 可應用於各種間照設計
- 零光斑 · 出光均勻柔和
- 高品質表面處理 · 高品質PC擴散面罩
- 型材、面罩長度一致 · 一刀完成切割

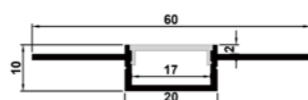
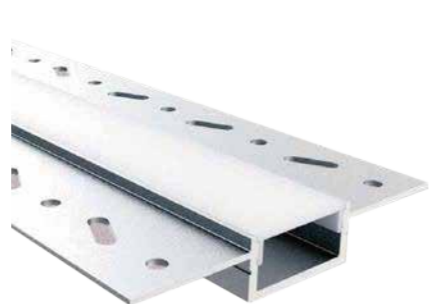

### ◆ 基本參數 BASIC PARAMETERS

|      |           |
|------|-----------|
| 鋁材質  | AL6063-T5 |
| 表面工藝 | 氧化亞銀處理    |
| 面罩材質 | 白色無光點PC罩  |
| 色號   | RAL9003   |

### ◆ 標準配備 STANDARD ACCESSORIES

#### 型材組件 Profile Components

|      |                  |  |
|------|------------------|--|
| 型材   | L3000*W60*H10 mm |  |
| 面罩   |                  |  |
| 堵頭*2 |                  |  |

### ◆ 選購配備 OPTIONAL ACCESSORIES

#### 安裝配件 Installation Accessories

安裝卡扣

#### 光源配件 Lighting Source

適用 2835 120燈/米 12w/ 3000K / 4000K / 6000K / 5mm / CRI>90  
適用 2835 182燈/米 15w/ 3000K / 4000K / 6000K / 10mm / CRI>90

## SL-T7615

- 可應用於各種間照設計
- 零光斑 · 出光均勻柔和
- 高品質表面處理 · 高品質PC擴散面罩
- 型材、面罩長度一致 · 一刀完成切割

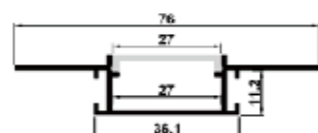

### ◆ 基本參數 BASIC PARAMETERS

|      |           |
|------|-----------|
| 鋁材質  | AL6063-T5 |
| 表面工藝 | 氧化亞銀處理    |
| 面罩材質 | 白色無光點PC罩  |
| 色號   | RAL9003   |

### ◆ 標準配備 STANDARD ACCESSORIES

#### 型材組件 Profile Components

|      |                  |  |
|------|------------------|--|
| 型材   | L3000*W76*H15 mm |  |
| 面罩   |                  |  |
| 堵頭*2 |                  |  |

### ◆ 選購配備 OPTIONAL ACCESSORIES

#### 安裝配件 Installation Accessories

安裝卡扣

#### 光源配件 Lighting Source

適用 2835 120燈/米 12w/ 3000K / 4000K / 6000K / 5mm / CRI>90  
適用 2835 182燈/米 15w/ 3000K / 4000K / 6000K / 10mm / CRI>90

## SL-T6916

- 可應用於各種間照設計
- 零光斑 · 出光均勻柔和
- 高品質表面處理 · 高品質PC擴散面罩
- 型材、面罩長度一致 · 一刀完成切割

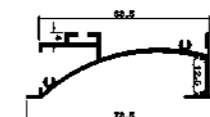

### ◆ 基本參數 BASIC PARAMETERS

|      |           |
|------|-----------|
| 鋁材質  | AL6063-T5 |
| 表面工藝 | 氧化亞銀處理    |
| 面罩材質 | 白色無光點PC罩  |
| 色號   | RAL9003   |

### ◆ 標準配備 STANDARD ACCESSORIES

#### 型材組件 Profile Components

|      |                      |  |
|------|----------------------|--|
| 型材   | L3000*W78.5*H26.2 mm |  |
| 面罩   |                      |  |
| 堵頭*2 |                      |  |

### ◆ 選購配備 OPTIONAL ACCESSORIES

#### 安裝配件 Installation Accessories

安裝卡扣



#### 光源配件 Lighting Source

適用 2835 120燈/米 12w/ 3000K / 4000K / 6000K / 5mm / CRI>90  
適用 2835 182燈/米 15w/ 3000K / 4000K / 6000K / 10mm / CRI>90

## SL-T9013

- 可應用於各種間照設計
- 零光斑 · 出光均勻柔和
- 高品質表面處理 · 高品質PC擴散面罩
- 型材、面罩長度一致 · 一刀完成切割

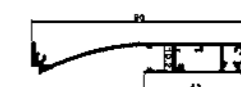

### ◆ 基本參數 BASIC PARAMETERS

|      |           |
|------|-----------|
| 鋁材質  | AL6063-T5 |
| 表面工藝 | 氧化亞銀處理    |
| 面罩材質 | 白色無光點PC罩  |
| 色號   | RAL9003   |

### ◆ 標準配備 STANDARD ACCESSORIES

#### 型材組件 Profile Components

|      |                  |  |
|------|------------------|--|
| 型材   | L3000*W13*H90 mm |  |
| 面罩   |                  |  |
| 堵頭*2 |                  |  |

### ◆ 選購配備 OPTIONAL ACCESSORIES

#### 安裝配件 Installation Accessories

安裝卡扣



#### 光源配件 Lighting Source

適用 2835 120燈/米 12w/ 3000K / 4000K / 6000K / 5mm / CRI>90  
適用 2835 182燈/米 15w/ 3000K / 4000K / 6000K / 10mm / CRI>90



## SL-T8016

- 可應用於各種間照設計
- 零光斑 · 出光均勻柔和
- 高品質表面處理 · 高品質PC擴散面罩
- 型材、面罩長度一致 · 一刀完成切割

### ◆ 基本參數 BASIC PARAMETERS

|      |           |
|------|-----------|
| 鋁材質  | AL6063-T5 |
| 表面工藝 | 氧化亞銀處理    |
| 面罩材質 | 白色無光點PC罩  |
| 色號   | RAL9003   |

### ◆ 標準配備 STANDARD ACCESSORIES

#### 型材組件 Profile Components

型材 L3000\*W16\*H80 mm

面罩

堵頭\*2

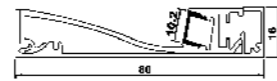
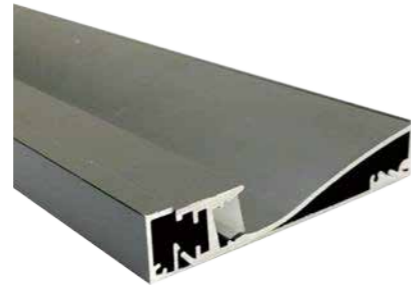

### ◆ 選購配備 OPTIONAL ACCESSORIES

#### 安裝配件 Installation Accessories

安裝卡扣

#### 光源配件 Lighting Source

適用 2835 120燈/米 12w/ 3000K / 4000K / 6000K / 5mm / CRI>90  
適用 2835 182燈/米 15w/ 3000K / 4000K / 6000K / 10mm / CRI>90

## SL-T12017

- 可應用於各種間照設計
- 零光斑 · 出光均勻柔和
- 高品質表面處理 · 高品質PC擴散面罩
- 型材、面罩長度一致 · 一刀完成切割

### ◆ 基本參數 BASIC PARAMETERS

|      |           |
|------|-----------|
| 鋁材質  | AL6063-T5 |
| 表面工藝 | 氧化亞銀處理    |
| 面罩材質 | 白色無光點PC罩  |
| 色號   | RAL9003   |

### ◆ 標準配備 STANDARD ACCESSORIES

#### 型材組件 Profile Components

型材 L3000\*W125\*H17.3 mm

面罩

堵頭\*2

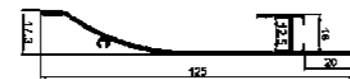
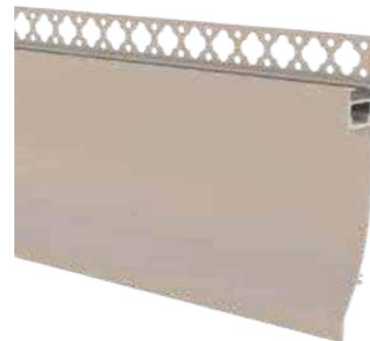

### ◆ 選購配備 OPTIONAL ACCESSORIES

#### 安裝配件 Installation Accessories

安裝卡扣

#### 光源配件 Lighting Source

適用 2835 120燈/米 12w/ 3000K / 4000K / 6000K / 5mm / CRI>90  
適用 2835 182燈/米 15w/ 3000K / 4000K / 6000K / 10mm / CRI>90

## SL-T1749

- 可應用於各種間照設計
- 零光斑 · 出光均勻柔和
- 高品質表面處理 · 高品質PC擴散面罩
- 型材、面罩長度一致 · 一刀完成切割

### ◆ 基本參數 BASIC PARAMETERS

|      |           |
|------|-----------|
| 鋁材質  | AL6063-T5 |
| 表面工藝 | 氧化亞銀處理    |
| 面罩材質 | 白色無光點PC罩  |
| 色號   | RAL9003   |

### ◆ 標準配備 STANDARD ACCESSORIES

#### 型材組件 Profile Components

型材 L3000\*W17\*H49 mm

面罩

堵頭\*2

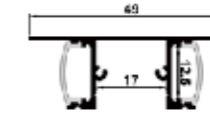

### ◆ 選購配備 OPTIONAL ACCESSORIES

#### 安裝配件 Installation Accessories

安裝卡扣

#### 光源配件 Lighting Source

適用 2835 120燈/米 12w/ 3000K / 4000K / 6000K / 5mm / CRI>90  
適用 2835 182燈/米 15w/ 3000K / 4000K / 6000K / 10mm / CRI>90

## SL-T13350

- 可應用於各種間照設計
- 零光斑 · 出光均勻柔和
- 高品質表面處理 · 高品質PC擴散面罩
- 型材、面罩長度一致 · 一刀完成切割

### ◆ 基本參數 BASIC PARAMETERS

|      |           |
|------|-----------|
| 鋁材質  | AL6063-T5 |
| 表面工藝 | 氧化亞銀處理    |
| 面罩材質 | 白色無光點PC罩  |
| 色號   | RAL9003   |

### ◆ 標準配備 STANDARD ACCESSORIES

#### 型材組件 Profile Components

型材 L3000\*W133.22\*H51.04 mm

面罩

堵頭\*2

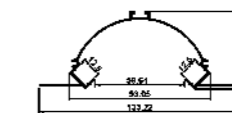

### ◆ 選購配備 OPTIONAL ACCESSORIES

#### 安裝配件 Installation Accessories

安裝卡扣

#### 光源配件 Lighting Source

適用 2835 120燈/米 12w/ 3000K / 4000K / 6000K / 5mm / CRI>90  
適用 2835 182燈/米 15w/ 3000K / 4000K / 6000K / 10mm / CRI>90

## SL-R9151

- 可應用於各種間照設計
- 零光斑 · 出光均勻柔和
- 高品質表面處理 · 高品質PC擴散面罩
- 型材、面罩長度一致 · 一刀完成切割

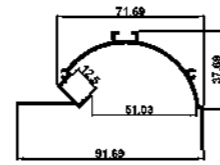

### ◆ 基本參數 BASIC PARAMETERS

|      |           |
|------|-----------|
| 鋁材質  | AL6063-T5 |
| 表面工藝 | 氧化亞銀處理    |
| 面罩材質 | 白色無光點PC罩  |
| 色號   | RAL9003   |

### ◆ 標準配備 STANDARD ACCESSORIES

#### 型材組件 Profile Components

型材 L3000\*W91.69\*H37.69 mm



面罩



堵頭\*2

### ◆ 選購配備 OPTIONAL ACCESSORIES

#### 安裝配件 Installation Accessories

安裝卡扣



#### 光源配件 Lighting Source

適用 2835 120燈/米 12w/ 3000K / 4000K / 6000K / 5mm / CRI>90  
適用 2835 182燈/米 15w/ 3000K / 4000K / 6000K / 10mm / CRI>90

## SL-R1742

- 可應用於各種間照設計
- 零光斑 · 出光均勻柔和
- 高品質表面處理 · 高品質PC擴散面罩
- 型材、面罩長度一致 · 一刀完成切割

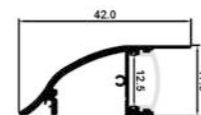

### ◆ 基本參數 BASIC PARAMETERS

|      |           |
|------|-----------|
| 鋁材質  | AL6063-T5 |
| 表面工藝 | 氧化亞銀處理    |
| 面罩材質 | 白色無光點PC罩  |
| 色號   | RAL9003   |

### ◆ 標準配備 STANDARD ACCESSORIES

#### 型材組件 Profile Components

型材 L3000\*W17.3\*H42 mm



面罩



堵頭\*2

### ◆ 選購配備 OPTIONAL ACCESSORIES

#### 安裝配件 Installation Accessories

安裝卡扣



#### 光源配件 Lighting Source

適用 2835 120燈/米 12w/ 3000K / 4000K / 6000K / 5mm / CRI>90  
適用 2835 182燈/米 15w/ 3000K / 4000K / 6000K / 10mm / CRI>90

## SL-R4168

- 可應用於各種間照設計
- 零光斑 · 出光均勻柔和
- 高品質表面處理 · 高品質PC擴散面罩
- 型材、面罩長度一致 · 一刀完成切割

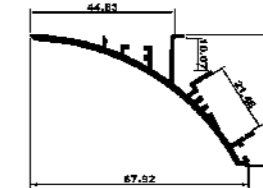

### ◆ 基本參數 BASIC PARAMETERS

|      |           |
|------|-----------|
| 鋁材質  | AL6063-T5 |
| 表面工藝 | 氧化亞銀處理    |
| 面罩材質 | 白色無光點PC罩  |
| 色號   | RAL9003   |

### ◆ 標準配備 STANDARD ACCESSORIES

#### 型材組件 Profile Components

型材 L3000\*W40.76\*H67.92 mm



面罩



堵頭\*2



### ◆ 選購配備 OPTIONAL ACCESSORIES

#### 安裝配件 Installation Accessories

安裝卡扣

#### 光源配件 Lighting Source

適用 2835 120燈/米 12w/ 3000K / 4000K / 6000K / 5mm / CRI>90  
適用 2835 182燈/米 15w/ 3000K / 4000K / 6000K / 10mm / CRI>90

## SL-R8115

- 可應用於各種間照設計
- 零光斑 · 出光均勻柔和
- 高品質表面處理 · 高品質PC擴散面罩
- 型材、面罩長度一致 · 一刀完成切割



### ◆ 基本參數 BASIC PARAMETERS

|      |           |
|------|-----------|
| 鋁材質  | AL6063-T5 |
| 表面工藝 | 氧化亞銀處理    |
| 面罩材質 | 白色無光點PC罩  |
| 色號   | RAL9003   |

### ◆ 標準配備 STANDARD ACCESSORIES

#### 型材組件 Profile Components

型材 L3000\*W81.4\*H15.7 mm



面罩



堵頭\*2



### ◆ 選購配備 OPTIONAL ACCESSORIES

#### 安裝配件 Installation Accessories

安裝卡扣

#### 光源配件 Lighting Source

適用 2835 120燈/米 12w/ 3000K / 4000K / 6000K / 5mm / CRI>90  
適用 2835 182燈/米 15w/ 3000K / 4000K / 6000K / 10mm / CRI>90

## SL-R44108

- 可應用於各種間照設計
- 零光斑，出光均勻柔和
- 高品質表面處理，高品質PC擴散面罩
- 型材、面罩長度一致，一刀完成切割

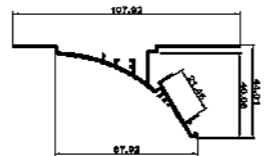

### ◆ 基本參數 BASIC PARAMETERS

|      |           |
|------|-----------|
| 鋁材質  | AL6063-T5 |
| 表面工藝 | 氧化亞銀處理    |
| 面罩材質 | 白色無光點PC罩  |
| 色號   | RAL9003   |

### ◆ 標準配備 STANDARD ACCESSORIES

#### 型材組件 Profile Components

|    |                         |
|----|-------------------------|
| 型材 | L3000*W44.01*H107.92 mm |
|----|-------------------------|



面罩



堵頭\*2



### ◆ 選購配備 OPTIONAL ACCESSORIES

#### 安裝配件 Installation Accessories

安裝卡扣

#### 光源配件 Lighting Source

適用 2835 120燈/米 12w/ 3000K / 4000K / 6000K / 5mm / CRI>90  
適用 2835 182燈/米 15w/ 3000K / 4000K / 6000K / 10mm / CRI>90

## SL-G1218

- 可應用於各種間照設計
- 零光斑，出光均勻柔和
- 高品質表面處理，高品質PC擴散面罩
- 型材、面罩長度一致，一刀完成切割

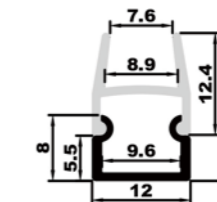

### ◆ 基本參數 BASIC PARAMETERS

|      |           |
|------|-----------|
| 鋁材質  | AL6063-T5 |
| 表面工藝 | 氧化亞銀處理    |
| 面罩材質 | 白色無光點PC罩  |
| 色號   | RAL9003   |

### ◆ 標準配備 STANDARD ACCESSORIES

#### 型材組件 Profile Components

|    |                  |
|----|------------------|
| 型材 | L2000*W12*H18 mm |
|----|------------------|



面罩



堵頭\*2



### ◆ 選購配備 OPTIONAL ACCESSORIES

#### 安裝配件 Installation Accessories

安裝卡扣

#### 光源配件 Lighting Source

適用 2835 120燈/米 12w/ 3000K / 4000K / 6000K / 5mm / CRI>90  
適用 2835 182燈/米 15w/ 3000K / 4000K / 6000K / 10mm / CRI>90

## SL-R7720

- 可應用於各種間照設計
- 零光斑，出光均勻柔和
- 高品質表面處理，高品質PC擴散面罩
- 型材、面罩長度一致，一刀完成切割

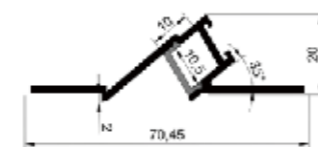

### ◆ 基本參數 BASIC PARAMETERS

|      |           |
|------|-----------|
| 鋁材質  | AL6063-T5 |
| 表面工藝 | 氧化亞銀處理    |
| 面罩材質 | 白色無光點PC罩  |
| 色號   | RAL9003   |

### ◆ 標準配備 STANDARD ACCESSORIES

#### 型材組件 Profile Components

|    |                     |
|----|---------------------|
| 型材 | L3000*W70.45*H20 mm |
|----|---------------------|



面罩



堵頭\*2



### ◆ 選購配備 OPTIONAL ACCESSORIES

#### 安裝配件 Installation Accessories

安裝卡扣

#### 光源配件 Lighting Source

適用 2835 120燈/米 12w/ 3000K / 4000K / 6000K / 5mm / CRI>90  
適用 2835 182燈/米 15w/ 3000K / 4000K / 6000K / 10mm / CRI>90

## SL-G2111

- 可應用於各種間照設計
- 零光斑，出光均勻柔和
- 高品質表面處理，高品質PC擴散面罩
- 型材、面罩長度一致，一刀完成切割

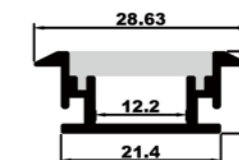

### ◆ 基本參數 BASIC PARAMETERS

|      |           |
|------|-----------|
| 鋁材質  | AL6063-T5 |
| 表面工藝 | 氧化亞銀處理    |
| 面罩材質 | 白色無光點PC罩  |
| 色號   | RAL9003   |

### ◆ 標準配備 STANDARD ACCESSORIES

#### 型材組件 Profile Components

|    |                    |
|----|--------------------|
| 型材 | L2000*W21.4*H11 mm |
|----|--------------------|



面罩



堵頭\*2



### ◆ 選購配備 OPTIONAL ACCESSORIES

#### 安裝配件 Installation Accessories

安裝卡扣



#### 光源配件 Lighting Source

適用 2835 120燈/米 12w/ 3000K / 4000K / 6000K / 5mm / CRI>90  
適用 2835 182燈/米 15w/ 3000K / 4000K / 6000K / 10mm / CRI>90

## SL-G1511

- 可應用於各種狹小空間
- 零光斑· 出光均勻柔和
- 高品質表面處理· 高品質PC擴散面罩
- 型材、面罩長度一致· 一刀完成切割

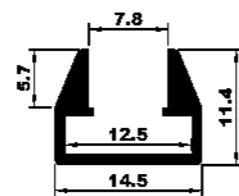

### ◆ 基本參數 BASIC PARAMETERS

|      |           |
|------|-----------|
| 鋁材質  | AL6063-T5 |
| 表面工藝 | 氧化亞銀處理    |
| 面罩材質 | 白色無光點PC罩  |
| 色號   | RAL9003   |

### ◆ 標準配備 STANDARD ACCESSORIES

#### 型材組件 Profile Components

|    |                      |
|----|----------------------|
| 型材 | L3000*W14.5*H11.4 mm |
|----|----------------------|



面罩



堵頭\*2

### ◆ 選購配備 OPTIONAL ACCESSORIES

#### 安裝配件 Installation Accessories

安裝卡扣

#### 光源配件 Lighting Source

適用 2835 120燈/米 12w/ 3000K / 4000K / 6000K / 5mm / CRI>90  
適用 2835 182燈/米 15w/ 3000K / 4000K / 6000K / 10mm / CRI>90

## SL-G2126

- 可應用於各種狹小空間
- 零光斑· 出光均勻柔和
- 高品質表面處理· 高品質PC擴散面罩
- 型材、面罩長度一致· 一刀完成切割

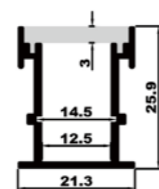

### ◆ 基本參數 BASIC PARAMETERS

|      |           |
|------|-----------|
| 鋁材質  | AL6063-T5 |
| 表面工藝 | 氧化亞銀處理    |
| 面罩材質 | 白色無光點PC罩  |
| 色號   | RAL9003   |

### ◆ 標準配備 STANDARD ACCESSORIES

#### 型材組件 Profile Components

|    |                      |
|----|----------------------|
| 型材 | L2000*W21.3*H25.9 mm |
|----|----------------------|



面罩



堵頭\*2



### ◆ 選購配備 OPTIONAL ACCESSORIES

#### 安裝配件 Installation Accessories

安裝卡扣



#### 光源配件 Lighting Source

適用 2835 120燈/米 12w/ 3000K / 4000K / 6000K / 5mm / CRI>90  
適用 2835 182燈/米 15w/ 3000K / 4000K / 6000K / 10mm / CRI>90

## SL-H1530

- 可應用於各種狹小空間
- 零光斑· 出光均勻柔和
- 高品質表面處理· 高品質PC擴散面罩
- 型材、面罩長度一致· 一刀完成切割

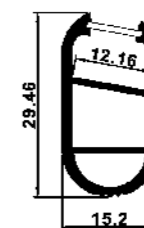

### ◆ 基本參數 BASIC PARAMETERS

|      |           |
|------|-----------|
| 鋁材質  | AL6063-T5 |
| 表面工藝 | 氧化亞銀處理    |
| 面罩材質 | 白色無光點PC罩  |
| 色號   | RAL9003   |

### ◆ 標準配備 STANDARD ACCESSORIES

#### 型材組件 Profile Components

|    |                       |
|----|-----------------------|
| 型材 | L3000*W15.2*H29.46 mm |
|----|-----------------------|



面罩



堵頭\*2



### ◆ 選購配備 OPTIONAL ACCESSORIES

#### 安裝配件 Installation Accessories

安裝卡扣



#### 光源配件 Lighting Source

適用 2835 120燈/米 12w/ 3000K / 4000K / 6000K / 5mm / CRI>90  
適用 2835 182燈/米 15w/ 3000K / 4000K / 6000K / 10mm / CRI>90

## SL-H1834

- 零光斑· 出光均勻柔和
- 高品質表面處理· 高品質PC擴散面罩
- 型材、面罩長度一致· 一刀完成切割

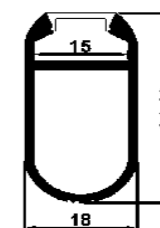

### ◆ 基本參數 BASIC PARAMETERS

|      |           |
|------|-----------|
| 鋁材質  | AL6063-T5 |
| 表面工藝 | 氧化亞銀處理    |
| 面罩材質 | 白色無光點PC罩  |
| 色號   | RAL9003   |

### ◆ 標準配備 STANDARD ACCESSORIES

#### 型材組件 Profile Components

|    |                     |
|----|---------------------|
| 型材 | L3000*W18*H34.19 mm |
|----|---------------------|



面罩



堵頭\*2



### ◆ 選購配備 OPTIONAL ACCESSORIES

#### 安裝配件 Installation Accessories

安裝卡扣



#### 光源配件 Lighting Source

適用 2835 120燈/米 12w/ 3000K / 4000K / 6000K / 5mm / CRI>90  
適用 2835 182燈/米 15w/ 3000K / 4000K / 6000K / 10mm / CRI>90

## SL-S6725

- 零光斑，出光均勻柔和
- 高品質表面處理，高品質PC擴散面罩
- 型材、面罩長度一致，一刀完成切割



### ◆ 基本參數 BASIC PARAMETERS

|      |           |
|------|-----------|
| 鋁材質  | AL6063-T5 |
| 表面工藝 | 氧化亞銀處理    |
| 面罩材質 | 白色無光點PC罩  |
| 色號   | RAL9003   |

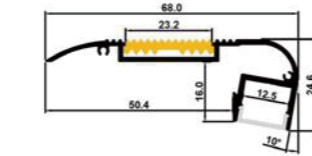

### ◆ 標準配備 STANDARD ACCESSORIES

#### 型材組件 Profile Components

|      |                    |  |
|------|--------------------|--|
| 型材   | L3000*W68*H24.6 mm |  |
| 面罩   |                    |  |
| 堵頭*2 |                    |  |

### ◆ 選購配備 OPTIONAL ACCESSORIES

#### 安裝配件 Installation Accessories

安裝卡扣

#### 光源配件 Lighting Source

適用 2835 120燈/米 12w/ 3000K / 4000K / 6000K / 5mm / CRI>90  
 適用 2835 182燈/米 15w/ 3000K / 4000K / 6000K / 10mm / CRI>90

## SL-S6826

- 零光斑，出光均勻柔和
- 高品質表面處理，高品質PC擴散面罩
- 型材、面罩長度一致，一刀完成切割



### ◆ 基本參數 BASIC PARAMETERS

|      |           |
|------|-----------|
| 鋁材質  | AL6063-T5 |
| 表面工藝 | 氧化亞銀處理    |
| 面罩材質 | 白色無光點PC罩  |
| 色號   | RAL9003   |

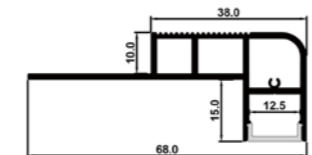

### ◆ 標準配備 STANDARD ACCESSORIES

#### 型材組件 Profile Components

|      |                    |  |
|------|--------------------|--|
| 型材   | L3000*W68*H26.3 mm |  |
| 面罩   |                    |  |
| 堵頭*2 |                    |  |

### ◆ 選購配備 OPTIONAL ACCESSORIES

#### 安裝配件 Installation Accessories

安裝卡扣

#### 光源配件 Lighting Source

適用 2835 120燈/米 12w/ 3000K / 4000K / 6000K / 5mm / CRI>90  
 適用 2835 182燈/米 15w/ 3000K / 4000K / 6000K / 10mm / CRI>90

# 環形照明方案





### 安裝應用方式



吊掛安裝



吸頂安裝



嵌入安裝

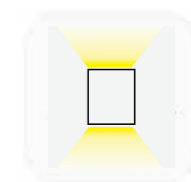

上下發光

### 鋁材表面處理

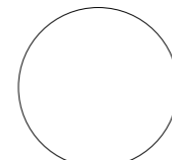

白色

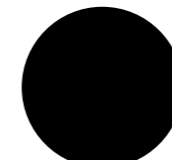

黑色



灰色



金色

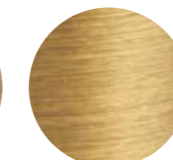

拉絲金色

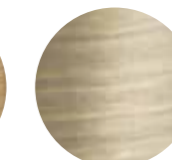

古銅色

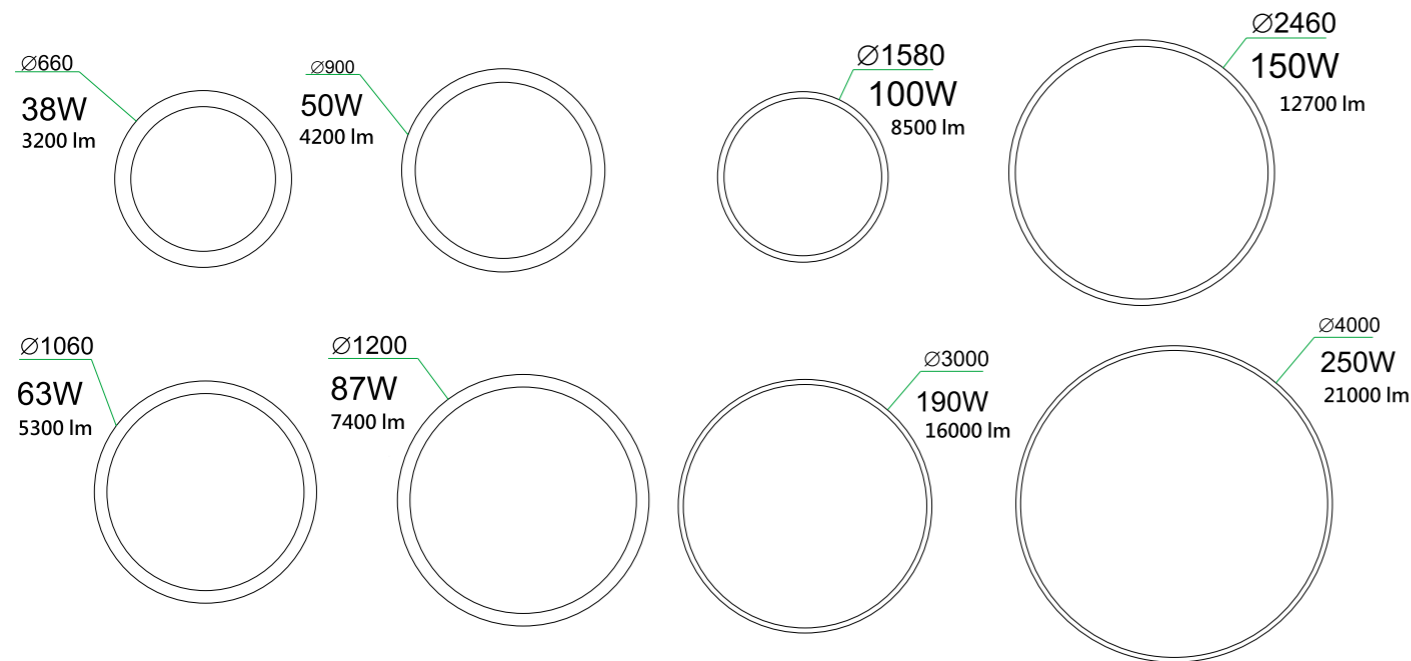

### 安裝應用方式



### 鋁材表面處理

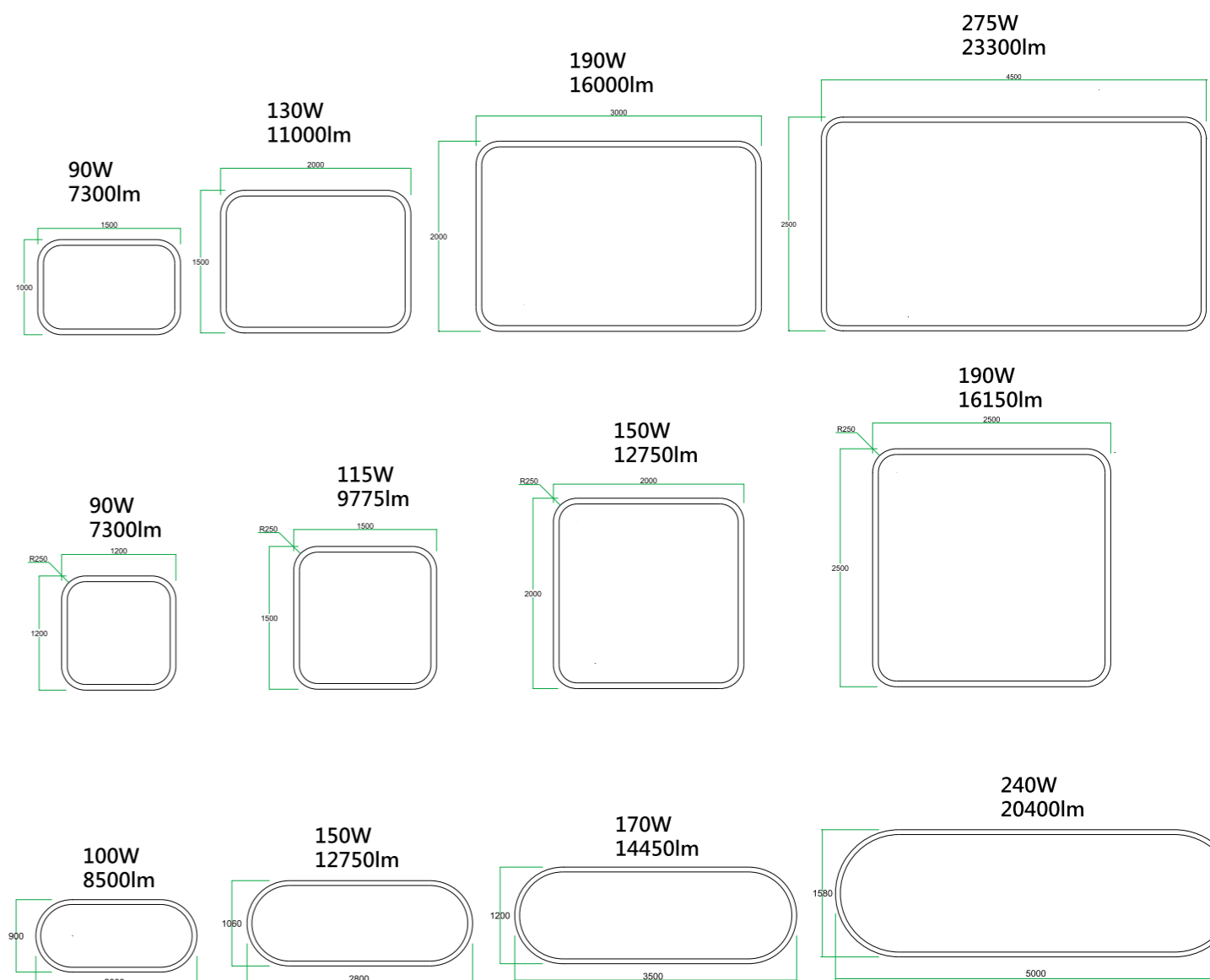

## SL6068 環型吊燈

- 吊掛安裝
- 零光斑 · 出光均勻柔和
- 高品質表面處理 · 高品質PC擴散面罩
- 型材、面罩長度一致 · 一刀完成切割

適用 2835 120燈/米 13w/ 3000K / 4000K / 6000K / 10mm / CRI>90

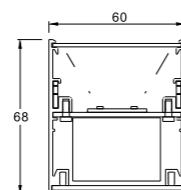
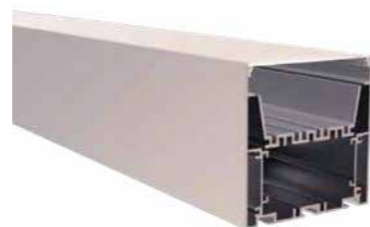

### ◆ 基本參數 BASIC PARAMETERS

|      |           |
|------|-----------|
| 鋁材質  | AL6063-T5 |
| 表面工藝 | 氧化亞銀處理    |
| 面罩材質 | 白色無光點PC罩  |
| 型材表面 |           |

### ◆ 標準配備 STANDARD ACCESSORIES

#### 型材組件 Profile Components

|      |           |  |
|------|-----------|--|
| 型材   | W60*H68mm |  |
| 面罩   |           |  |
| 堵頭*2 |           |  |

### ◆ 選購配備 OPTIONAL ACCESSORIES

#### 安裝配件 Installation Accessories

| 安裝卡扣                        |     |         |         |         |            |
|-----------------------------|-----|---------|---------|---------|------------|
| <b>光源配件 Lighting Source</b> |     |         |         |         |            |
| 型號                          | 電壓  | 光通量     | 最大功率    | 每米燈珠    | 最小裁剪       |
| L1120                       | 24v | 640LM/m | 10.2W/m | 120LEDs | 25mm/3LEDs |



## SL3535 環型

- 吊掛安裝
- 零光斑 · 出光均勻柔和
- 高品質表面處理 · 高品質PC擴散面罩
- 型材、面罩長度一致 · 一刀完成切割

適用 2835 120燈/米 13w/ 3000K / 4000K / 6000K / 10mm / CRI>90

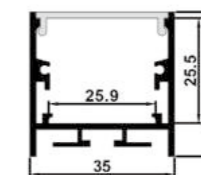

### ◆ 基本參數 BASIC PARAMETERS

|      |           |
|------|-----------|
| 鋁材質  | AL6063-T5 |
| 表面工藝 | 氧化亞銀處理    |
| 面罩材質 | 白色無光點PC罩  |
| 型材表面 |           |

### ◆ 標準配備 STANDARD ACCESSORIES

#### 型材組件 Profile Components

|      |           |  |
|------|-----------|--|
| 型材   | W35*H35mm |  |
| 面罩   |           |  |
| 堵頭*2 |           |  |

### ◆ 選購配備 OPTIONAL ACCESSORIES

#### 安裝配件 Installation Accessories

|      |  |
|------|--|
| 安裝卡扣 |  |
|------|--|





# 弧線照明方案



### 安裝應用方式



吊掛安裝



吸頂安裝



嵌入安裝



上下發光

### 鋁材表面處理

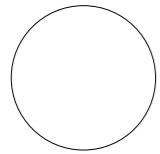

白色

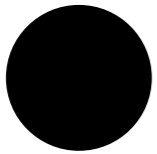

黑色



灰色



金色



拉絲金色

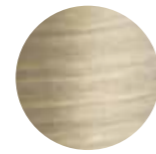

古銅色

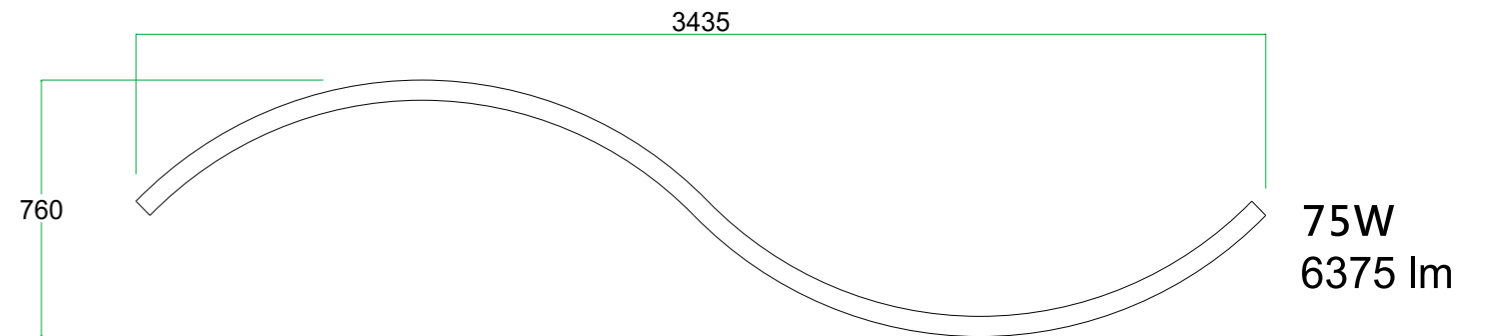
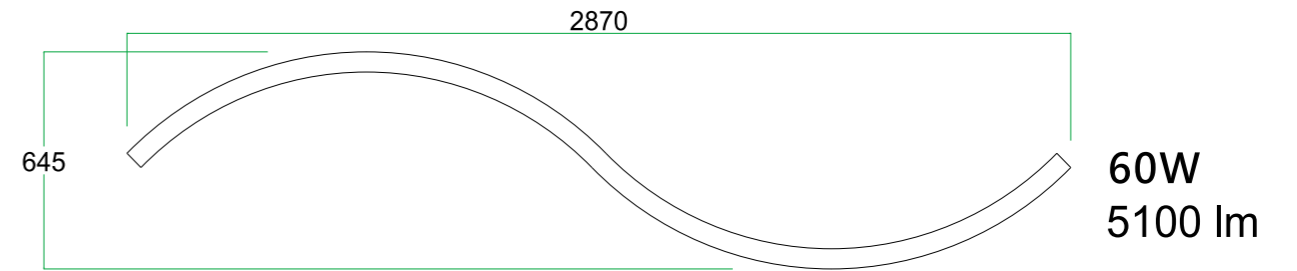
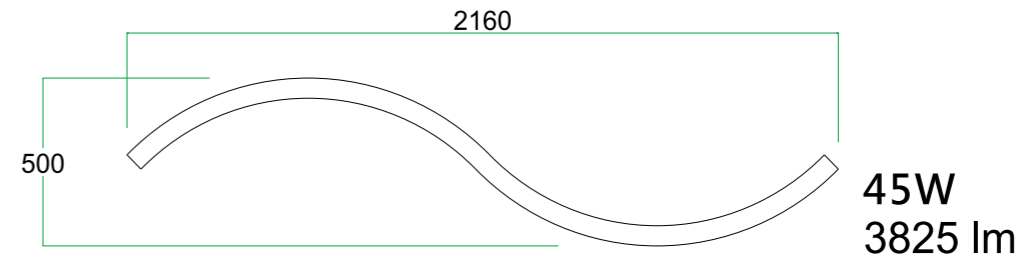
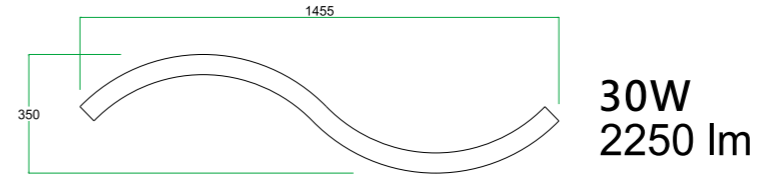
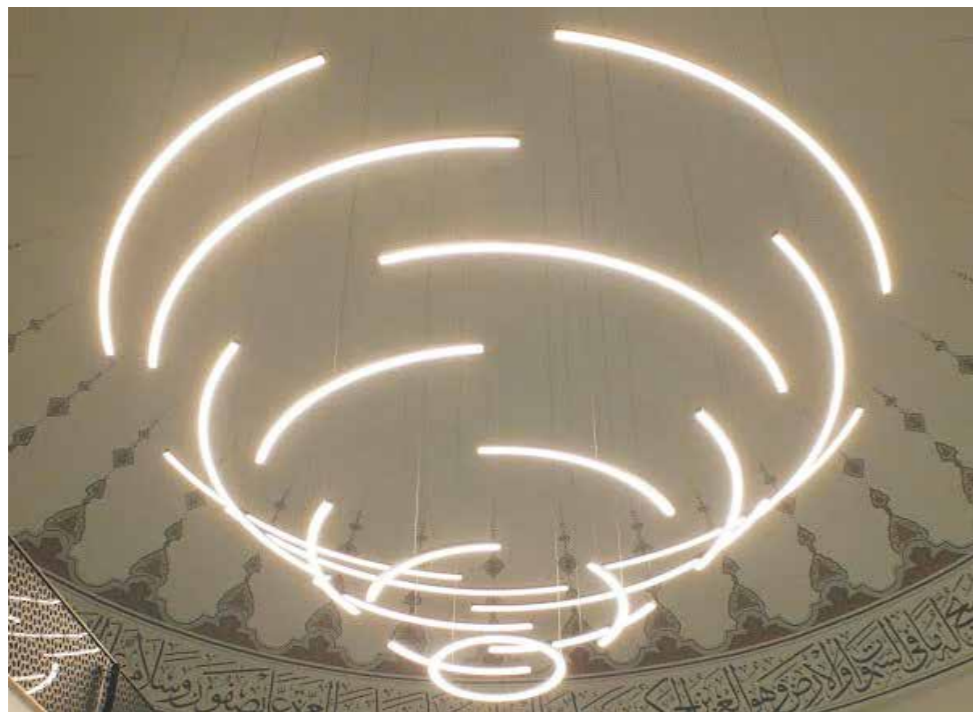

## SL6068 環型吊燈

- 吊掛安裝
- 零光斑 · 出光均勻柔和
- 高品質表面處理 · 高品質PC擴散面罩
- 型材、面罩長度一致 · 一刀完成切割

適用 2835 120燈/米 13w/ 3000K / 4000K / 6000K / 10mm / CRI>90

### ◆ 基本參數 BASIC PARAMETERS

|      |           |
|------|-----------|
| 鋁材質  | AL6063-T5 |
| 表面工藝 | 氧化亞銀處理    |
| 面罩材質 | 白色無光點PC罩  |
| 型材表面 |           |

### ◆ 標準配備 STANDARD ACCESSORIES

#### 型材組件 Profile Components

|      |           |  |
|------|-----------|--|
| 型材   | W60*H68mm |  |
| 面罩   |           |  |
| 堵頭*2 |           |  |

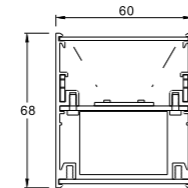
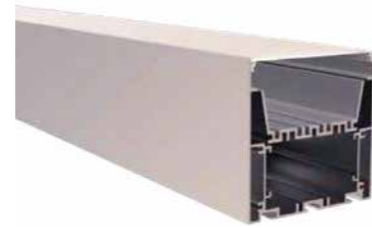

### ◆ 選購配備 OPTIONAL ACCESSORIES

#### 安裝配件 Installation Accessories

鋼繩

#### 光源配件 Lighting Source

| 型號    | 電壓  | 光通量     | 最大功率    | 每米燈珠    | 最小裁剪       |
|-------|-----|---------|---------|---------|------------|
| L1120 | 24v | 640LM/m | 10.2W/m | 120LEDs | 25mm/3LEDs |



## SL3535 環型

- 吊掛安裝
- 零光斑 · 出光均勻柔和
- 高品質表面處理 · 高品質PC擴散面罩
- 型材、面罩長度一致 · 一刀完成切割

適用 2835 120燈/米 13w/ 3000K / 4000K / 6000K / 10mm / CRI>90

### ◆ 基本參數 BASIC PARAMETERS

|      |           |
|------|-----------|
| 鋁材質  | AL6063-T5 |
| 表面工藝 | 氧化亞銀處理    |
| 面罩材質 | 白色無光點PC罩  |
| 型材表面 |           |

### ◆ 標準配備 STANDARD ACCESSORIES

#### 型材組件 Profile Components

|      |           |  |
|------|-----------|--|
| 型材   | W35*H35mm |  |
| 面罩   |           |  |
| 堵頭*2 |           |  |

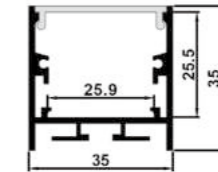

### ◆ 選購配備 OPTIONAL ACCESSORIES

#### 安裝配件 Installation Accessories

安裝卡扣



# 矽膠霓虹燈條

Neon Flex contains silicone neon and PU neon, silicone neon is IP65/IP67, used indoor or outdoor. PU neon is ture IP68, used underwater.

Silicone Neon, is made by adopting three-color silicone integrated extrusion shaping process, and it's protection grade reaches up to IP65/IP67, featuring resistances to saline solutions, acid & alkali, corrosive gases, fire and UV, applying to indoor and outdoor molding decoration, building outlines,city night scenes illuminating and so forth for the sake of the effect of decorative lighting.PU Neon, is made by

TPU U shape milky tube and filling with opal PU glue, it's protection grade reaches up to IP68, UV resistant and saltwater resistant, used for underwater decorative lighting.



# Neon Flex 線性照明方案

線性照明方案

線性照明方案

出線

標準端蓋

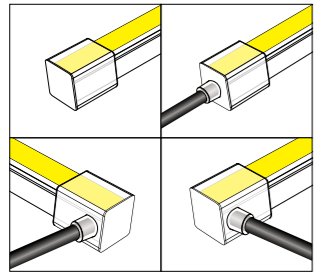

不斷光接頭方案

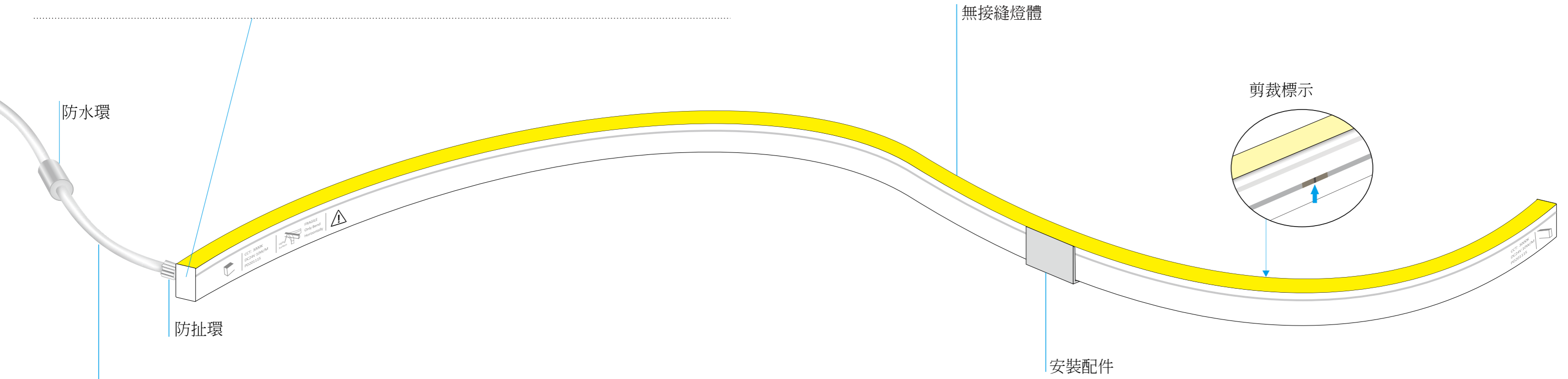
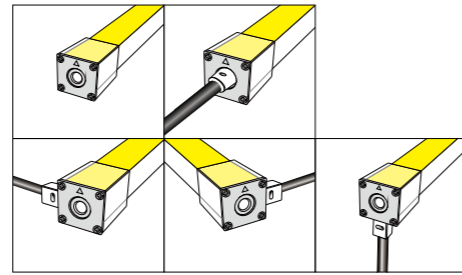
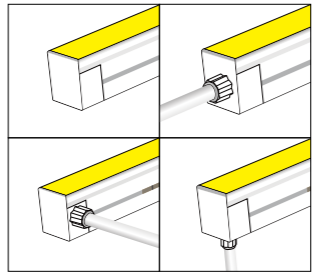

IP65/67 防水接頭

公頭



16mm

42mm

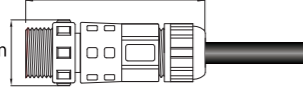

母頭

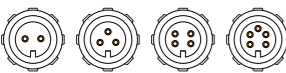

16mm

41mm

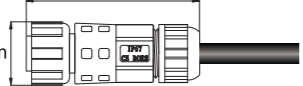

夾扣

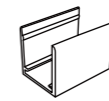

鋁條

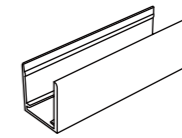

龍骨架



# 防水等級

IP65

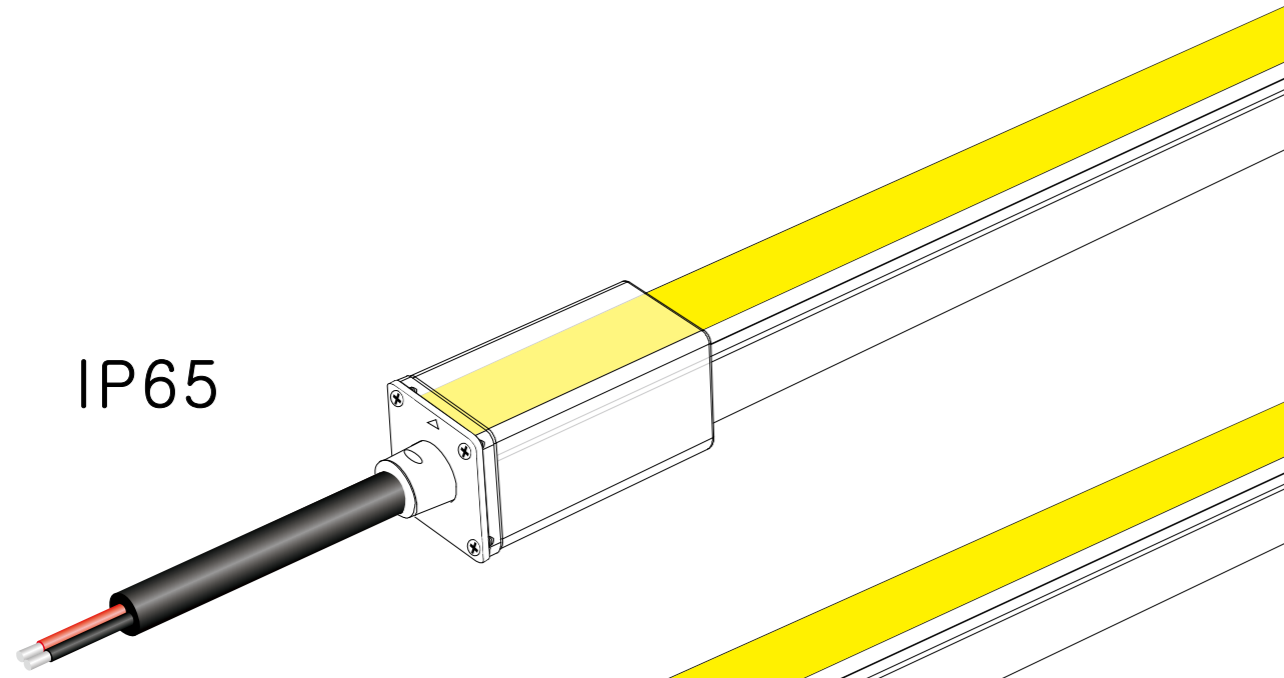

IP67

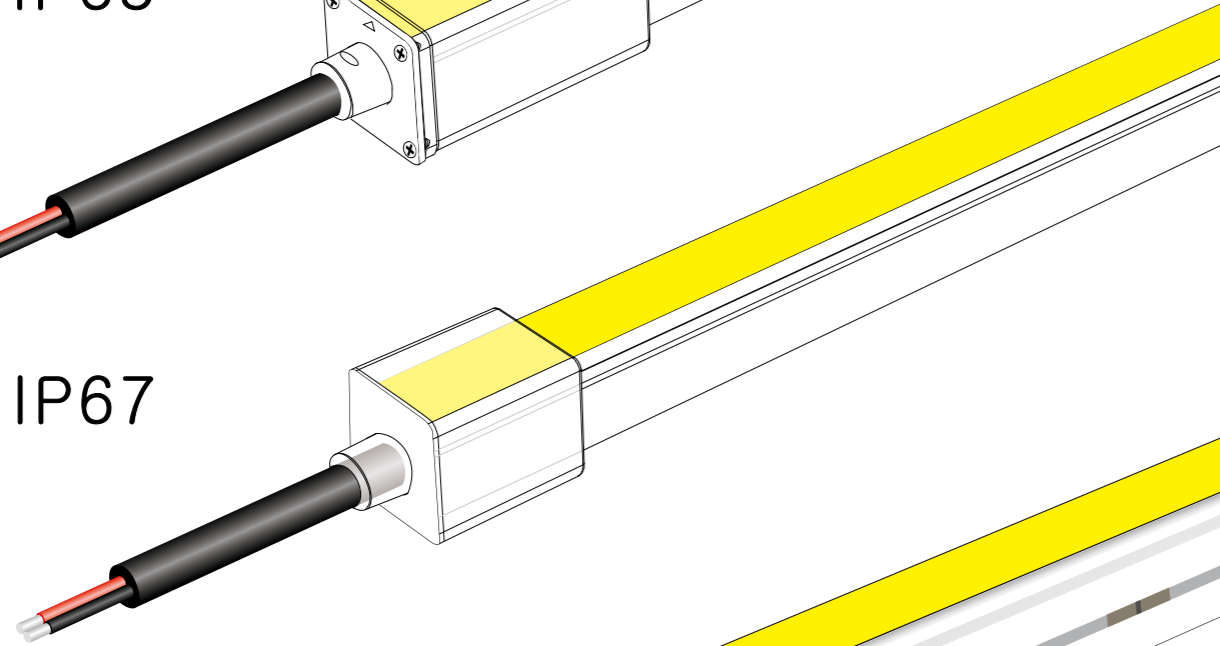

IP67

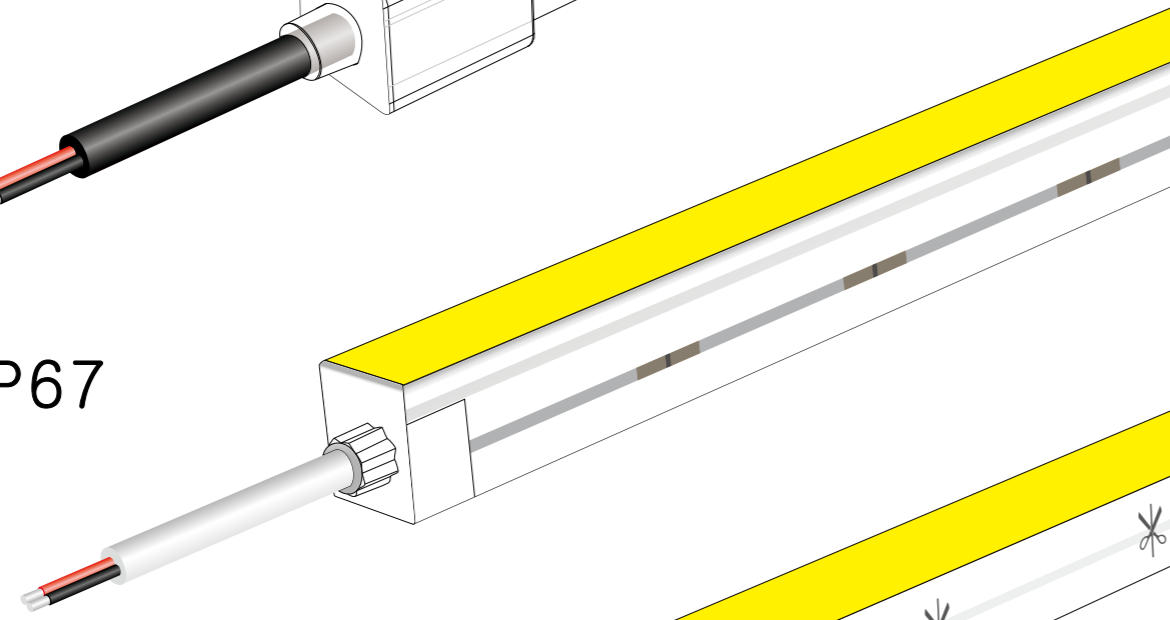

IP68

(PU NEON)

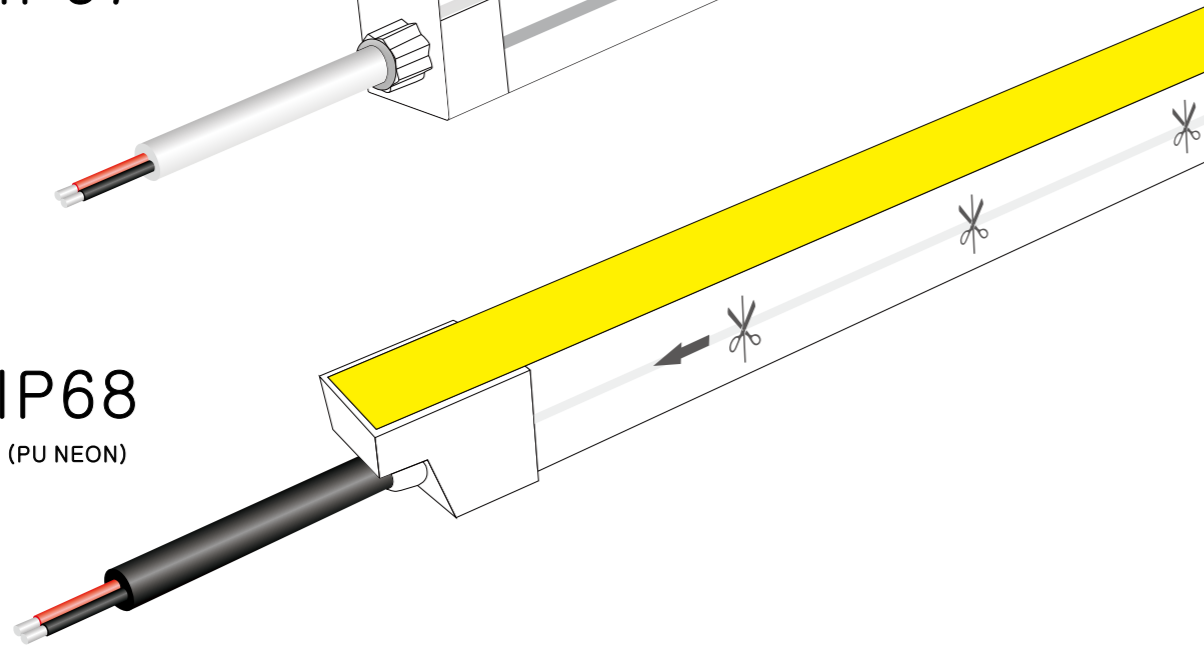

## 防水結構

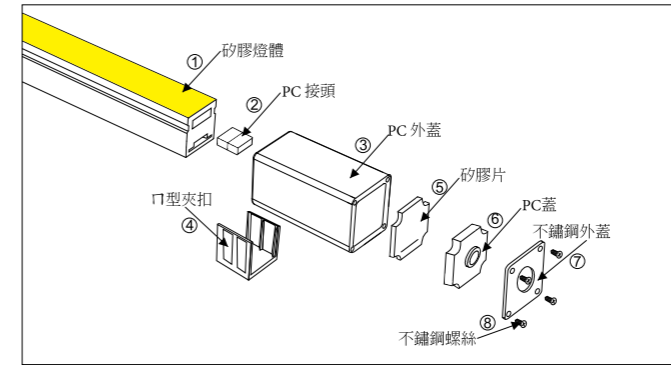

IP67 無縫接頭

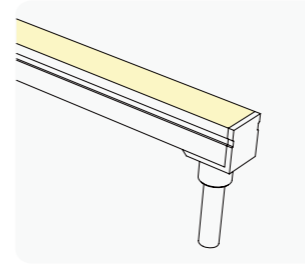

可不斷光對接

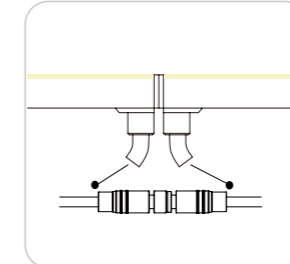

側發光環型對接

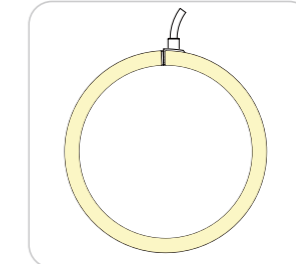

正發光環型對接

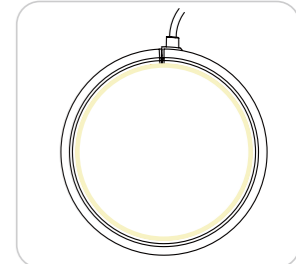

IP68 專用防水接頭

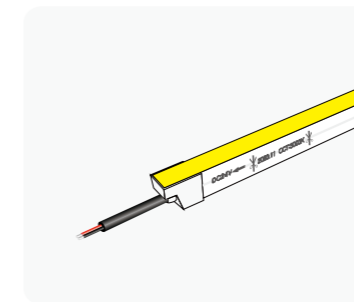

水下3米防水



# 側發光 S0408 NEON

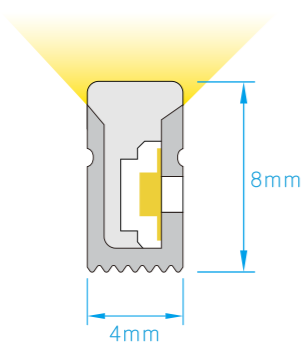

3000K - 6000K



## 尺寸

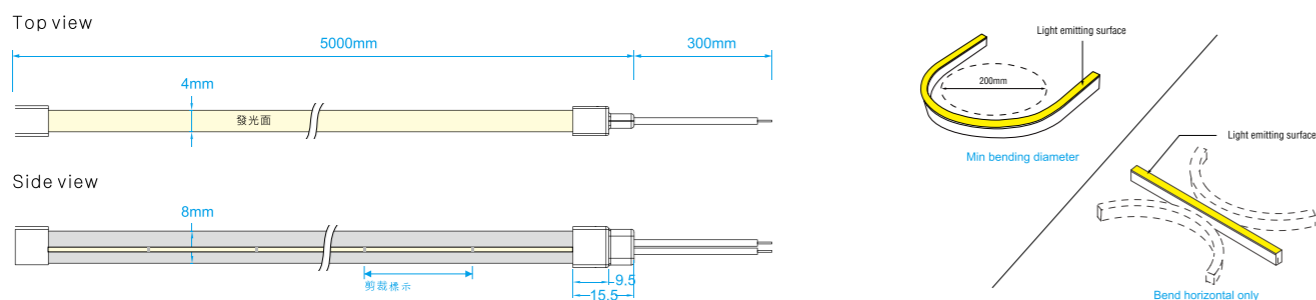

## 規格參數

|        |            |
|--------|------------|
| 輸入電壓   | DC24 V     |
| 演色性/Ra | >90        |
| 環境溫度   | -25°C~45°C |

## 配光曲線

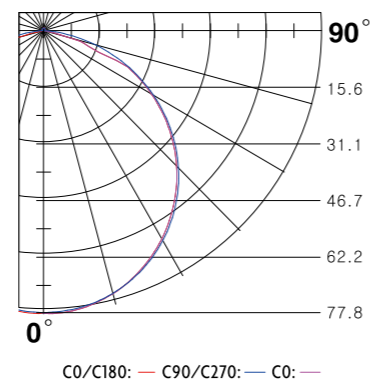

# 側發光 S0612 NEON

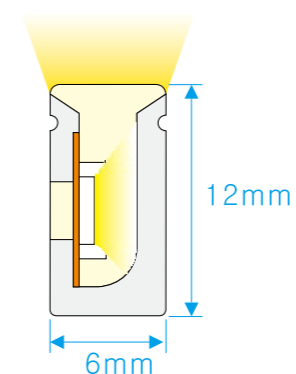

3000K - 6000K



## 尺寸

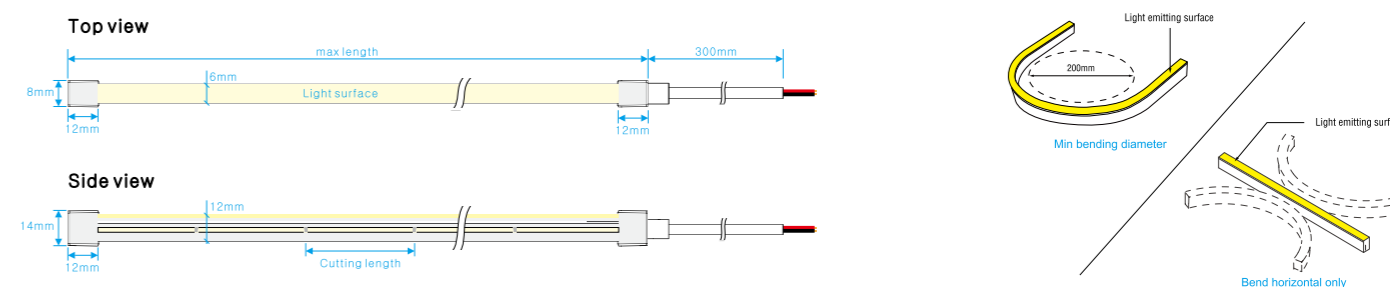

## 規格參數

|        |            |
|--------|------------|
| 輸入電壓   | DC24 V     |
| 演色性/Ra | >90        |
| 環境溫度   | -25°C~45°C |

## 配光曲線

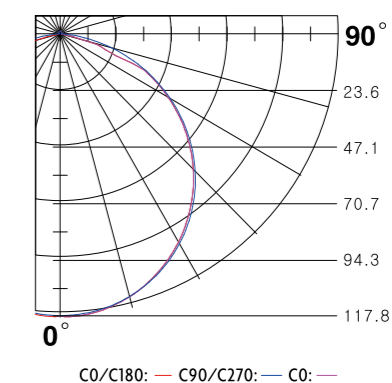

# 側發光 S1023 NEON

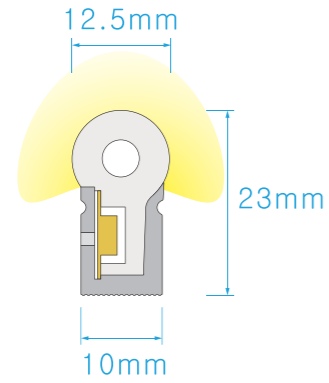

3000K - 6000K



## 尺寸

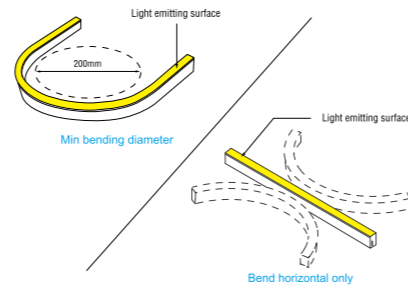
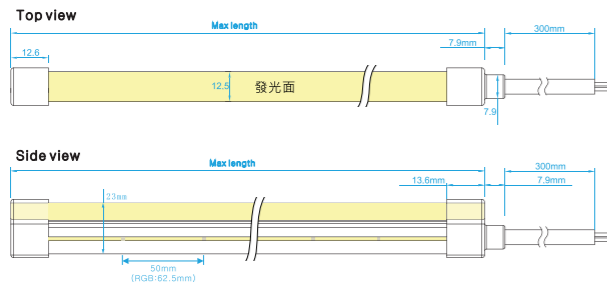

## 規格參數

|        |            |
|--------|------------|
| 輸入電壓   | DC24 V     |
| 演色性/Ra | >90        |
| 環境溫度   | -25°C~45°C |

## 配光曲線

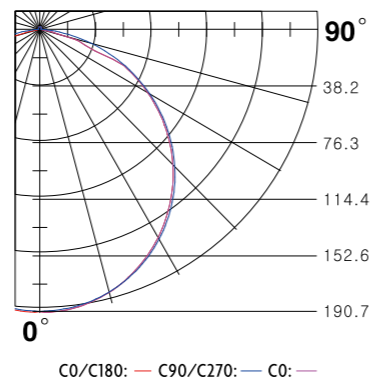

# 側發光 S1225 NEON

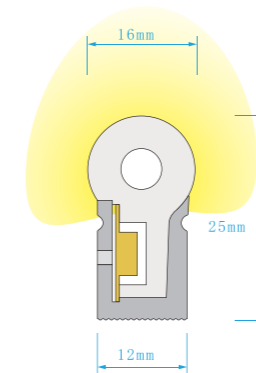

3000K - 6000K



## 尺寸

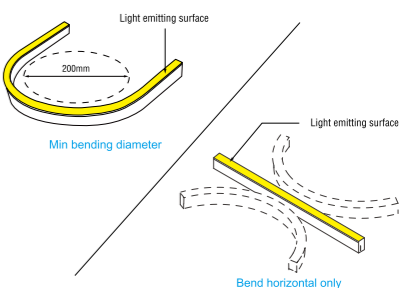
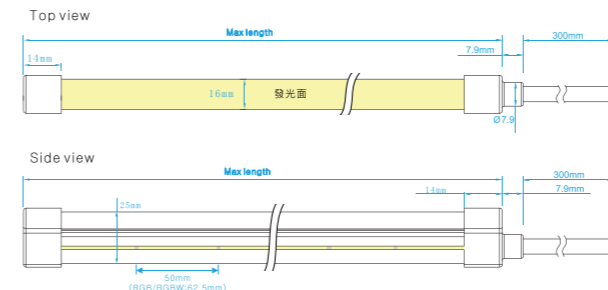

## 規格參數

|        |            |
|--------|------------|
| 輸入電壓   | DC24 V     |
| 演色性/Ra | >90        |
| 環境溫度   | -25°C~45°C |

## 配光曲線

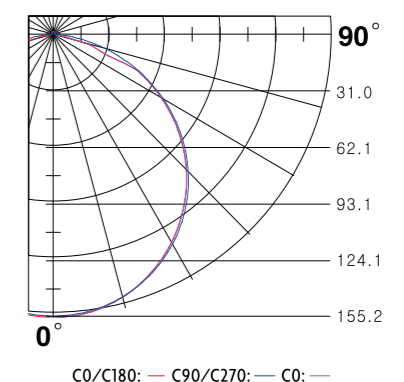



# 側發光 S0817 NEON

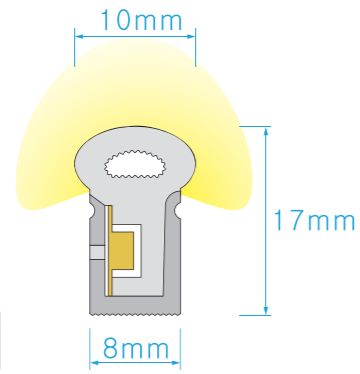

3000K - 6000K



## 尺寸

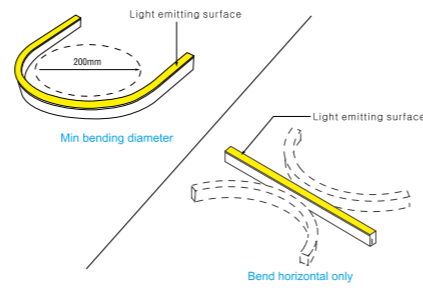
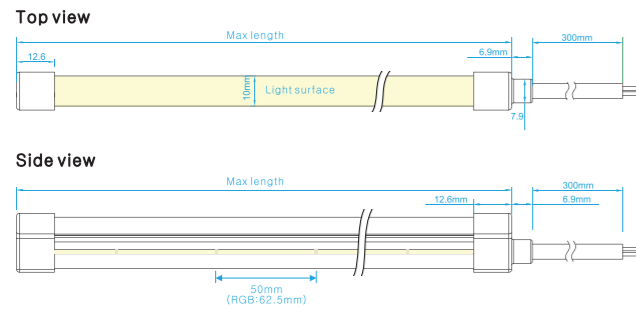

## 規格參數

|        |            |
|--------|------------|
| 輸入電壓   | DC24 V     |
| 演色性/Ra | >90        |
| 環境溫度   | -25°C~45°C |

## 配光曲線 (The data base on 10W 4000K)

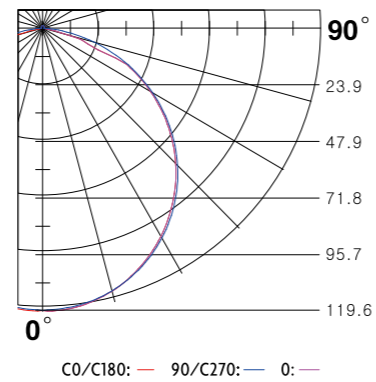

# 側發光 S1018 NEON

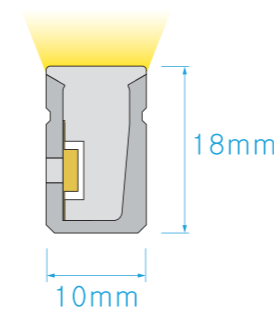

3000K - 6000K



## 尺寸

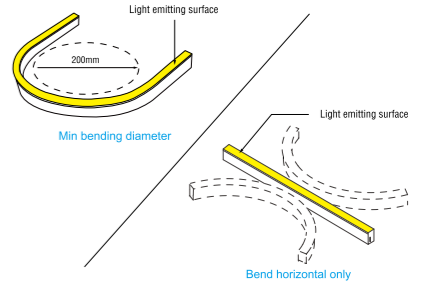
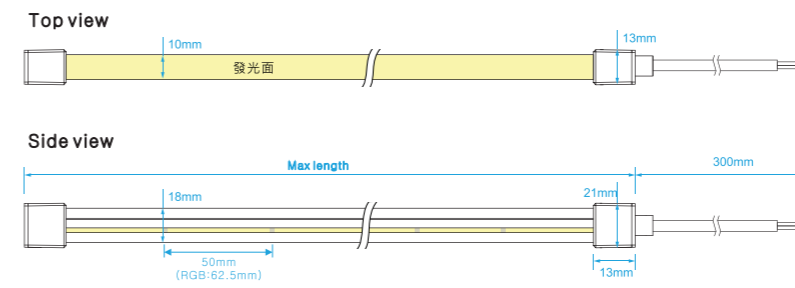

## 規格參數

|        |            |
|--------|------------|
| 輸入電壓   | DC24 V     |
| 演色性/Ra | >90        |
| 環境溫度   | -25°C~45°C |

## 配光曲線

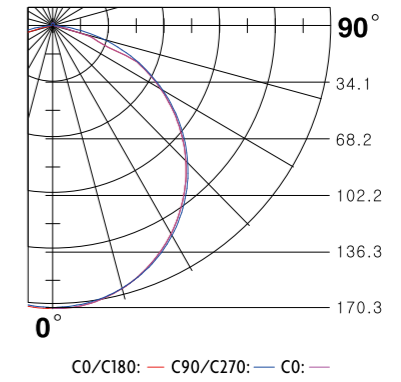

# 側發光 S1220 NEON

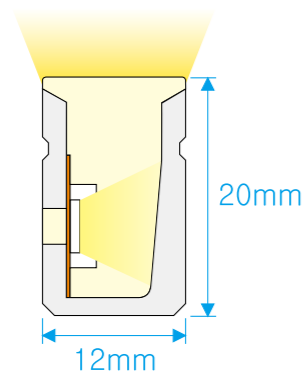

3000K - 6000K



## 尺寸

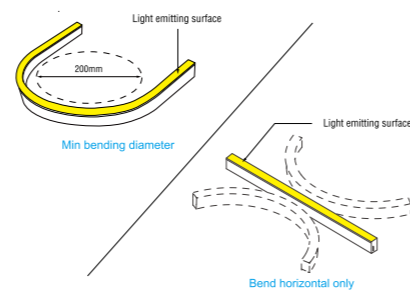
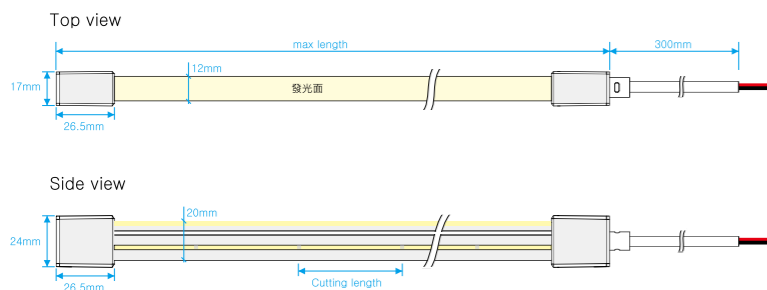

## 規格產數

|        |            |
|--------|------------|
| 輸入電壓   | DC24 V     |
| 演色性/Ra | >90        |
| 環境溫度   | -25°C~45°C |

## 配光曲線

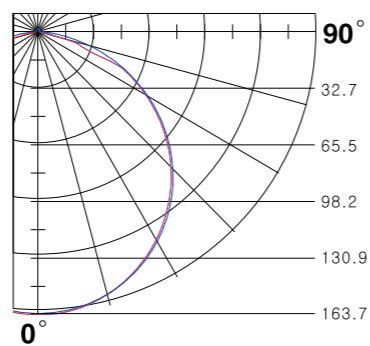

C0/C180: — C90/C270: — C0: —

# 側發光 T1616 NEON

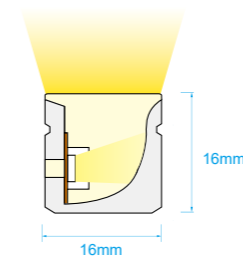

3000K - 6000K



## 尺寸

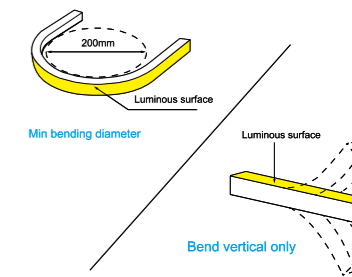
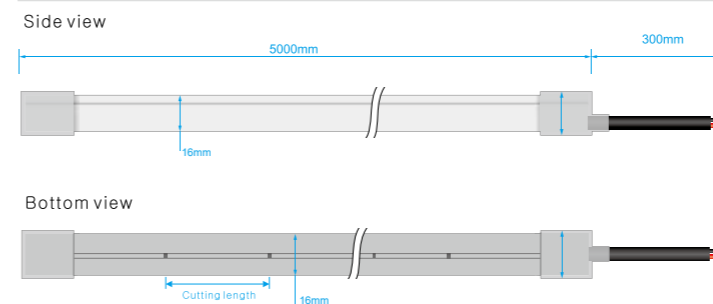

## 規格參數

|        |            |
|--------|------------|
| 輸入電壓   | DC24 V     |
| 演色性/Ra | >90        |
| 環境溫度   | -25°C~45°C |

## 配光曲線

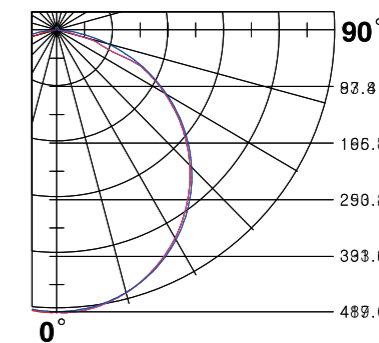

C0/C180: — C90/C270: — C0: —

# 側發光 T2020 NEON

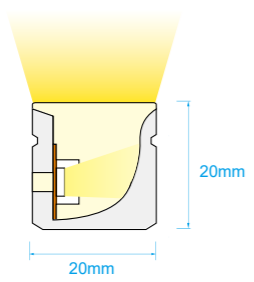

3000K - 6000K

- One Bin
- CRI >90
- Solvent resistant
- Saltwater resistant
- UV protected
- Cuttable
- 50000 Hours Lifetime
- LM80 Compliant

## 尺寸

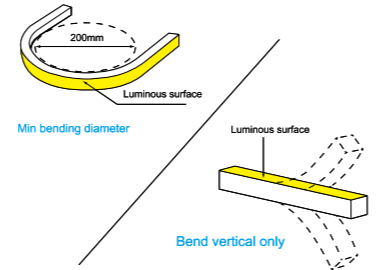
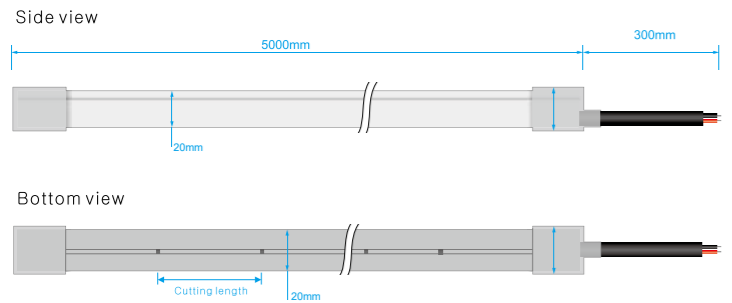

## 規格參數

|        |            |
|--------|------------|
| 輸入電壓   | DC24 V     |
| 演色性/Ra | >90        |
| 環境溫度   | -25°C~45°C |

## 配光曲線

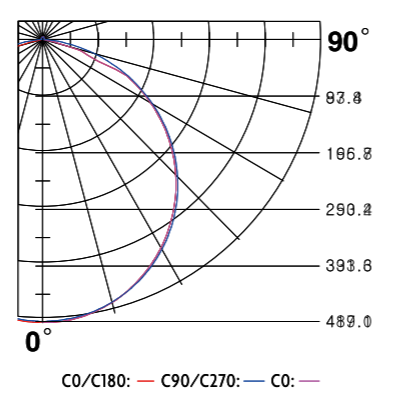

# 側發光 S1225B NEON



3000K - 6000K



## 尺寸

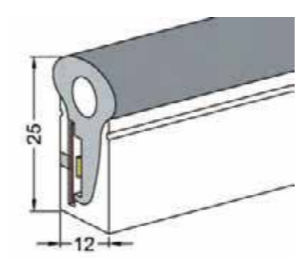

## 規格參數

|        |            |
|--------|------------|
| 輸入電壓   | DC24 V     |
| 演色性/Ra | >90        |
| 環境溫度   | -25°C~45°C |

## 配光曲線

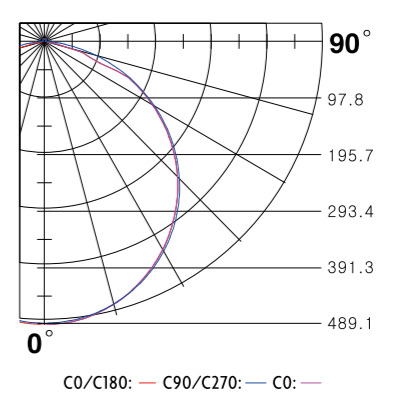

# 側發光 S0410 NEON

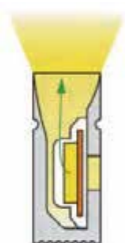

3000K - 6000K

尺寸

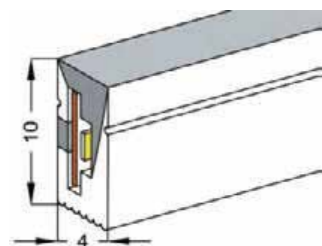

## 規格參數

|        |            |
|--------|------------|
| 輸入電壓   | DC24V      |
| 演色性/Ra | >90        |
| 環境溫度   | -25°C~45°C |

## 配光曲線

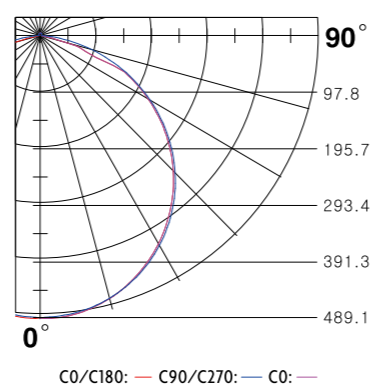

# 側發光 S0612B NEON

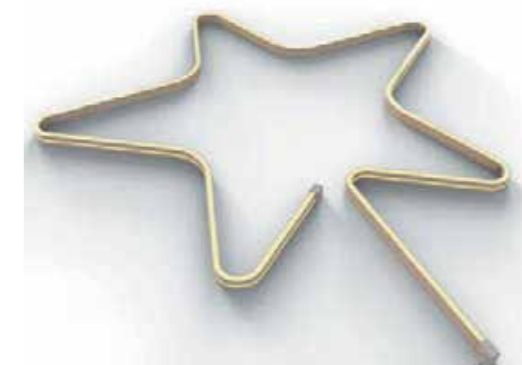

3000K - 6000K

尺寸

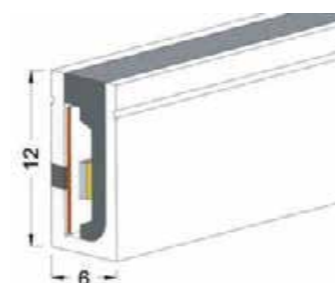

## 規格參數

|        |            |
|--------|------------|
| 輸入電壓   | DC24V      |
| 演色性/Ra | >90        |
| 環境溫度   | -25°C~45°C |

## 配光曲線

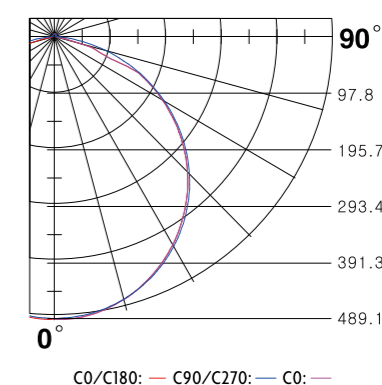

# 側發光 S0613 NEON

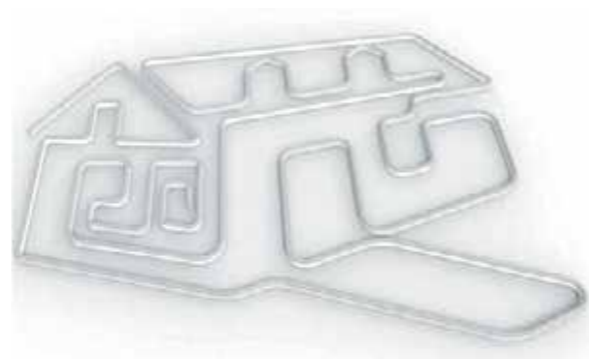

3000K - 6000K

尺寸

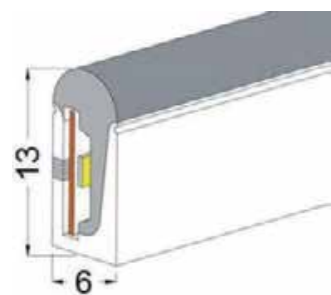

## 規格參數

|        |            |
|--------|------------|
| 輸入電壓   | DC24 V     |
| 演色性/Ra | >90        |
| 環境溫度   | -25°C~45°C |

## 配光曲線

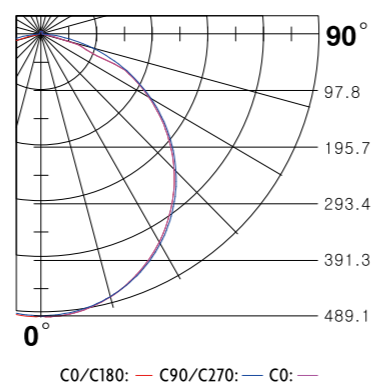

# 側發光 S1220B NEON

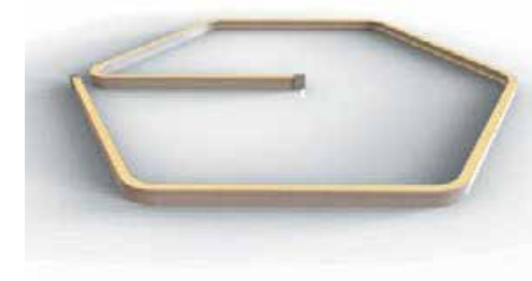

3000K - 6000K

尺寸

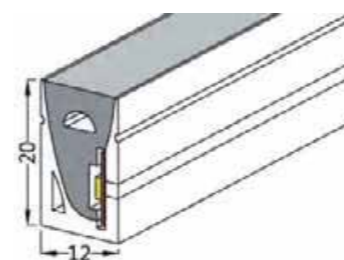

## 規格參數

|        |            |
|--------|------------|
| 輸入電壓   | DC24 V     |
| 演色性/Ra | >90        |
| 環境溫度   | -25°C~45°C |

## 配光曲線

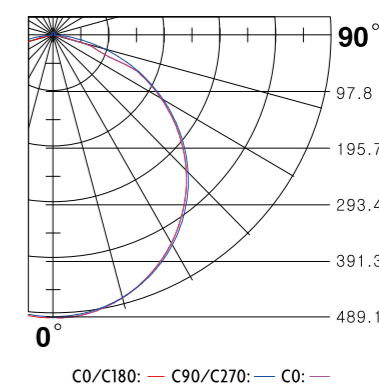

# 側發光 S1220B NEON

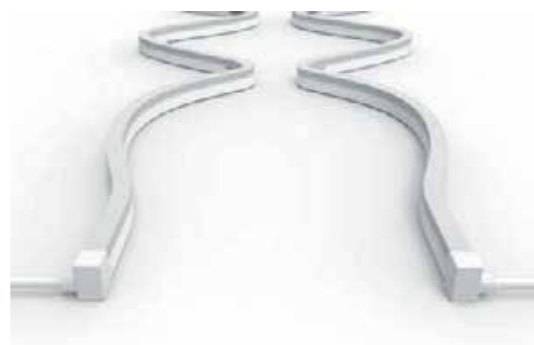
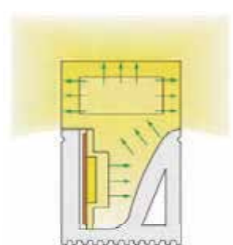

3000K - 6000K

尺寸

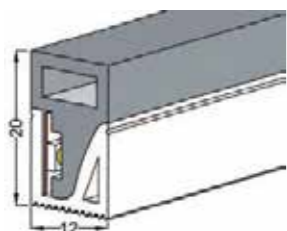

## 規格參數

|        |            |
|--------|------------|
| 輸入電壓   | DC24 V     |
| 演色性/Ra | >90        |
| 環境溫度   | -25°C~45°C |

## 配光曲線

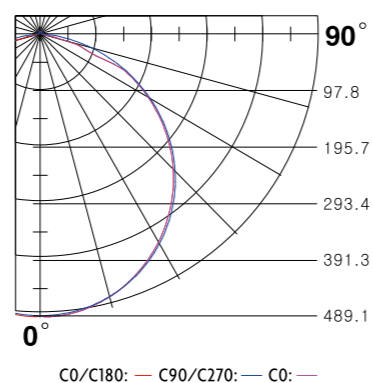

# 側發光 S1018B NEON

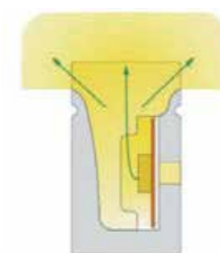

3000K - 6000K

尺寸

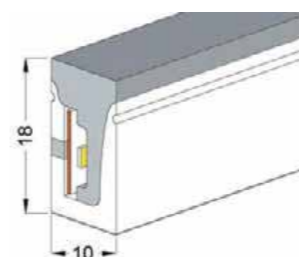

## 規格參數

|        |            |
|--------|------------|
| 輸入電壓   | DC24 V     |
| 演色性/Ra | >90        |
| 環境溫度   | -25°C~45°C |

## 配光曲線

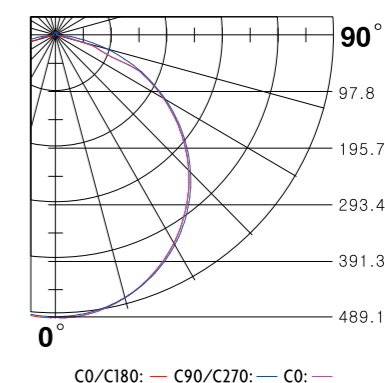

# 側發光 S3032 NEON



3000K - 6000K

尺寸

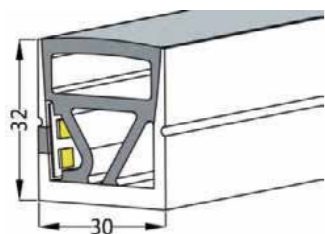

## 規格參數

|        |            |
|--------|------------|
| 輸入電壓   | DC24 V     |
| 演色性/Ra | >90        |
| 環境溫度   | -25°C~45°C |

## 配光曲線

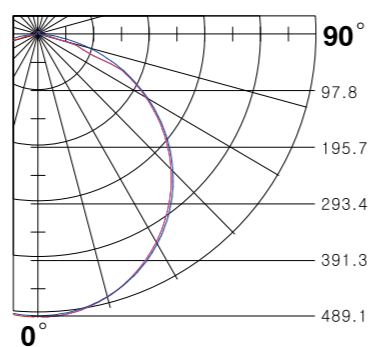

C0/C180: — C90/C270: — C0: —

# 側發光 S0815 NEON

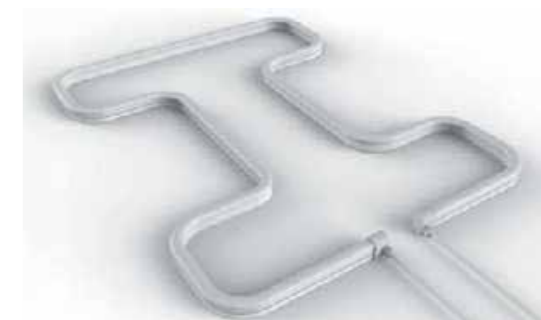
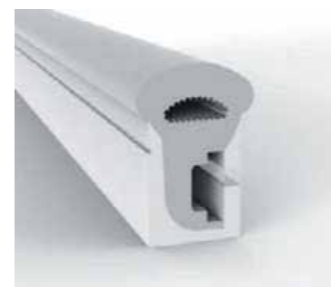

3000K - 6000K

尺寸

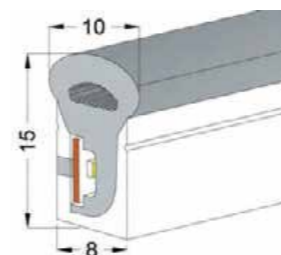

## 規格參數

|        |            |
|--------|------------|
| 輸入電壓   | DC24 V     |
| 演色性/Ra | >90        |
| 環境溫度   | -25°C~45°C |

## 配光曲線

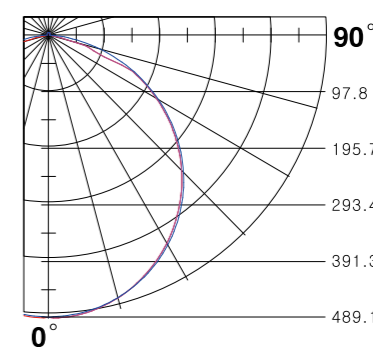

C0/C180: — C90/C270: — C0: —

# 側發光 S0817 NEON

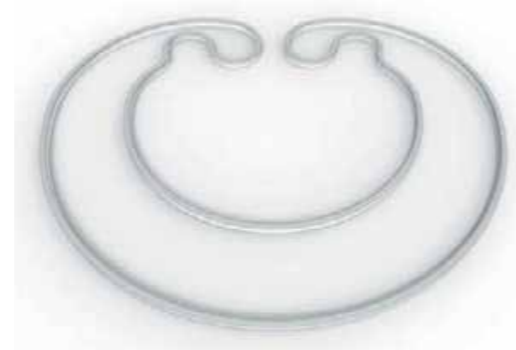
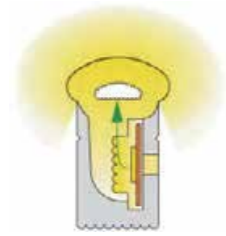

3000K - 6000K

尺寸

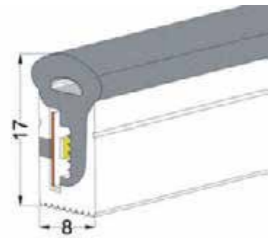

規格參數

|        |            |
|--------|------------|
| 輸入電壓   | DC24 V     |
| 演色性/Ra | >90        |
| 環境溫度   | -25°C~45°C |

配光曲線

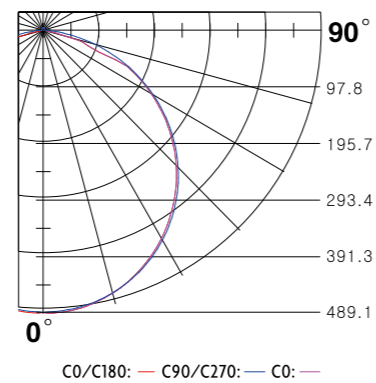

# 側發光 S1023 NEON

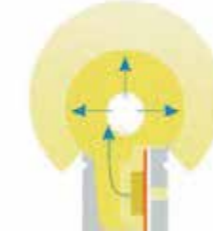

3000K - 6000K

尺寸

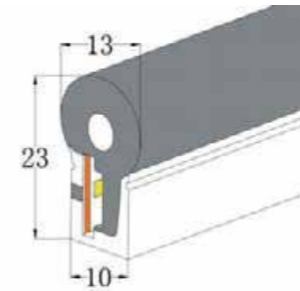

規格參數

|        |            |
|--------|------------|
| 輸入電壓   | DC24 V     |
| 演色性/Ra | >90        |
| 環境溫度   | -25°C~45°C |

配光曲線

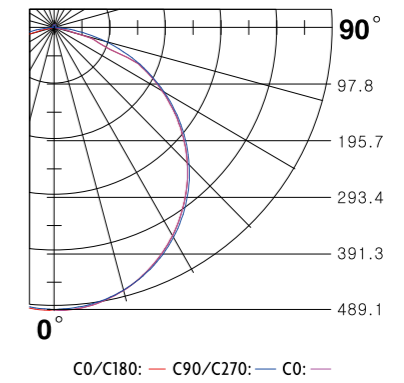



# 正發光 T1105 NEON

線性照明方案

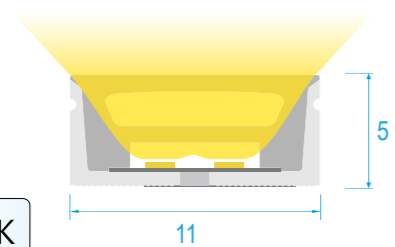

3000K - 6000K



## 尺寸

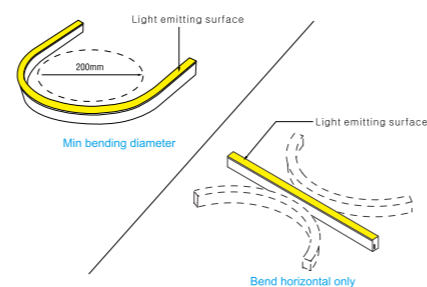
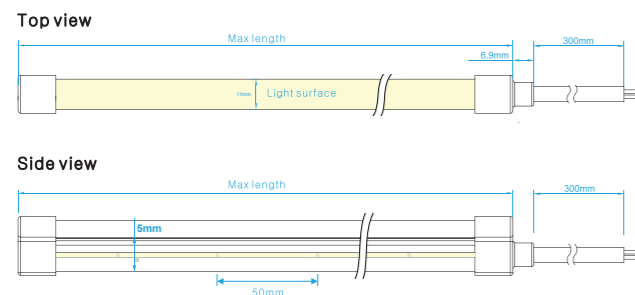

## 規格參數

|        |            |
|--------|------------|
| 輸入電壓   | DC24 V     |
| 演色性/Ra | >90        |
| 環境溫度   | -25°C~45°C |

## 配光曲線 (The data base on 10W 4000K)

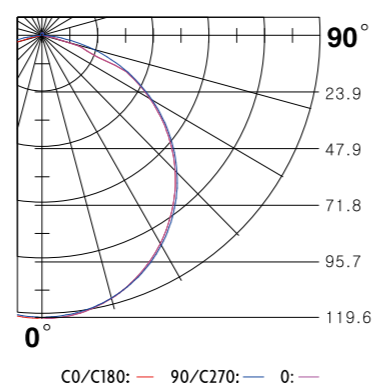

# 正發光 T1305 NEON

線性照明方案

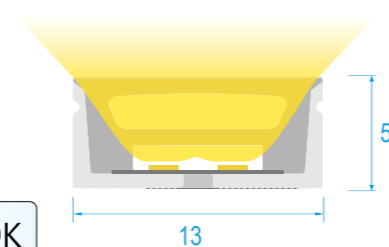

3000K - 6000K



## 尺寸

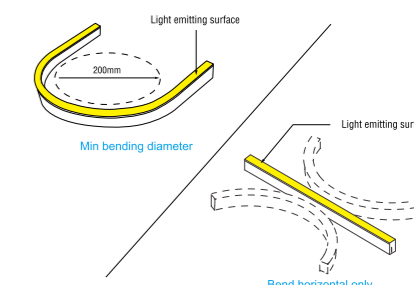
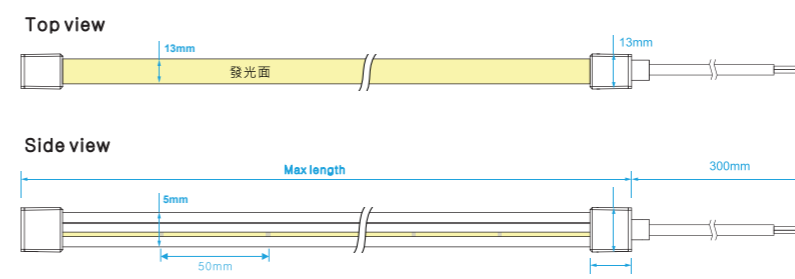

## 規格參數

|        |            |
|--------|------------|
| 輸入電壓   | DC24 V     |
| 演色性/Ra | >90        |
| 環境溫度   | -25°C~45°C |

## 配光曲線

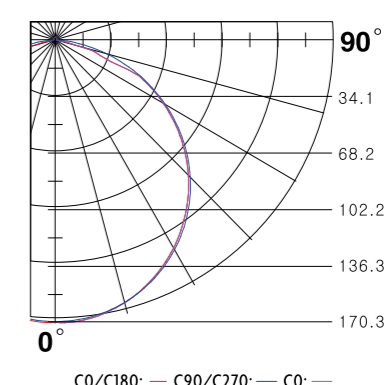

# 正發光 T1505 NEON

線性照明方案

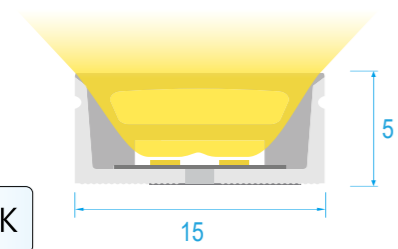

3000K - 6000K



## 尺寸

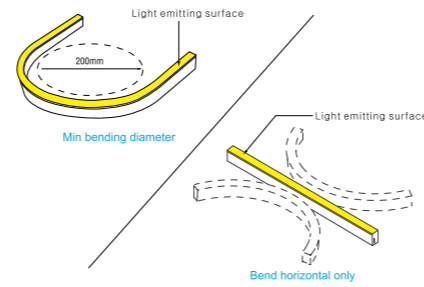
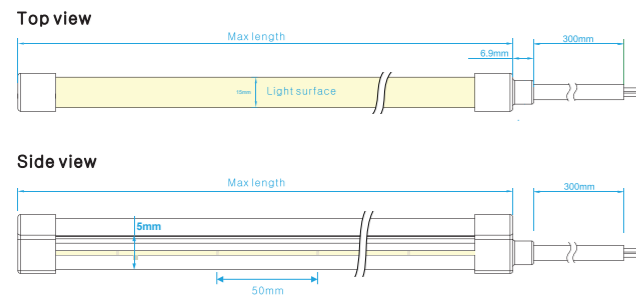

## 規格參數

|        |            |
|--------|------------|
| 輸入電壓   | DC24 V     |
| 演色性/Ra | >90        |
| 環境溫度   | -25°C~45°C |

## 配光曲線 (The data base on 10W 4000K)

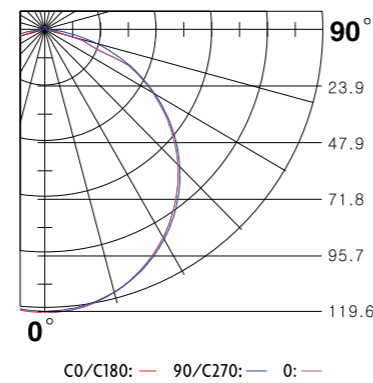

# 正發光 T0606 NEON

線性照明方案

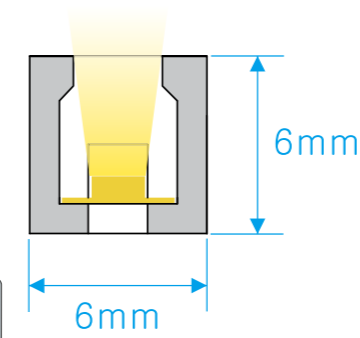

3000K - 6000K



## 尺寸

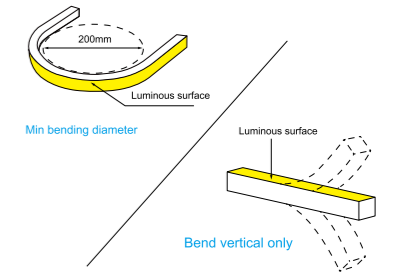
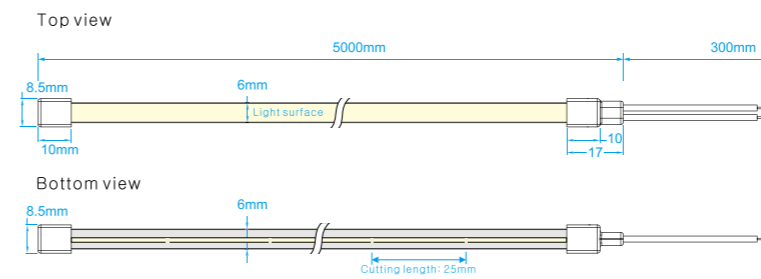

## 規格參數

|        |            |
|--------|------------|
| 輸入電壓   | DC24 V     |
| 演色性/Ra | >90        |
| 環境溫度   | -25°C~45°C |

## 配光曲線

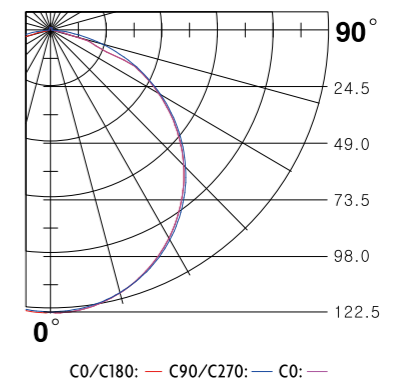

# 正發光 T1010 NEON

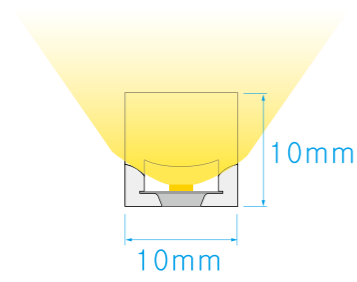

3000K - 6000K



## 尺寸

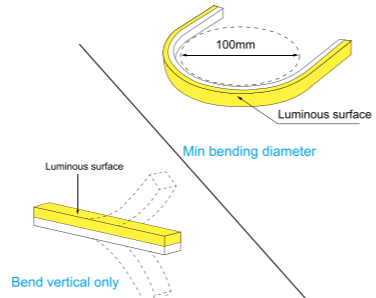
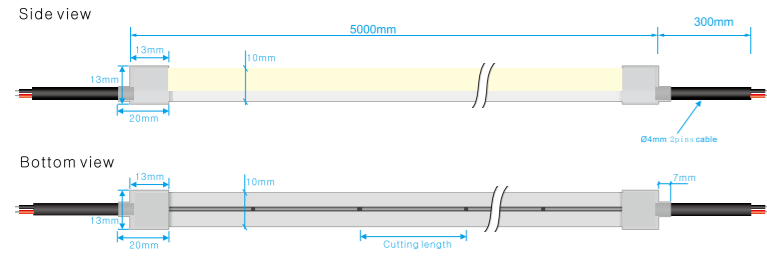

## 規格參數

|        |            |
|--------|------------|
| 輸入電壓   | DC24 V     |
| 演色性/Ra | >90        |
| 環境溫度   | -25°C~45°C |

## 配光曲線

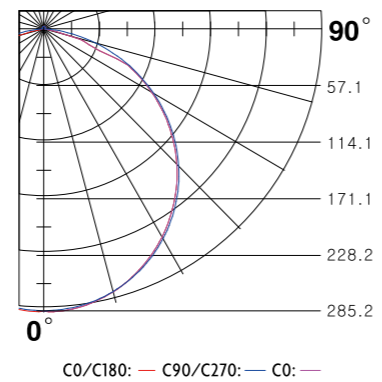

# 正發光 T1212 NEON

線性照明方案

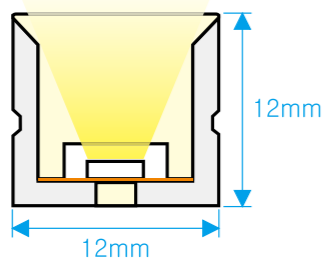

3000K - 6000K



## 尺寸

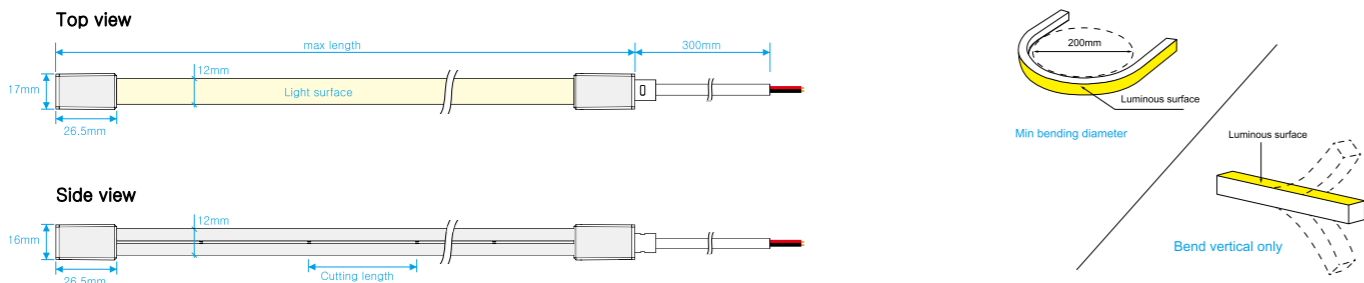

## 規格參數

|        |            |
|--------|------------|
| 輸入電壓   | DC24 V     |
| 演色性/Ra | >90        |
| 環境溫度   | -25°C~45°C |

## 配光曲線

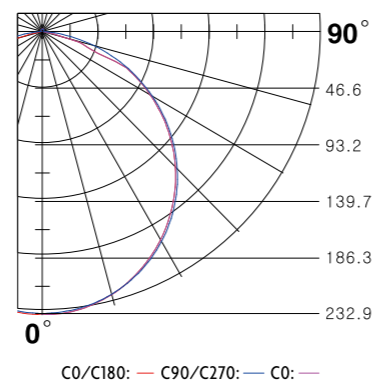

# 正發光 T1615 NEON

線性照明方案

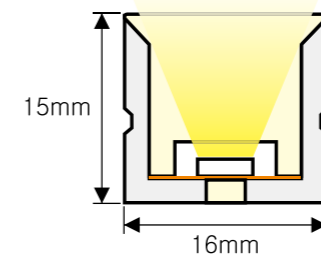

3000K - 6000K

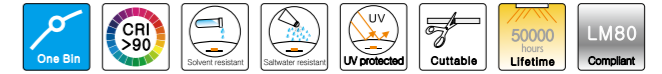

## 尺寸

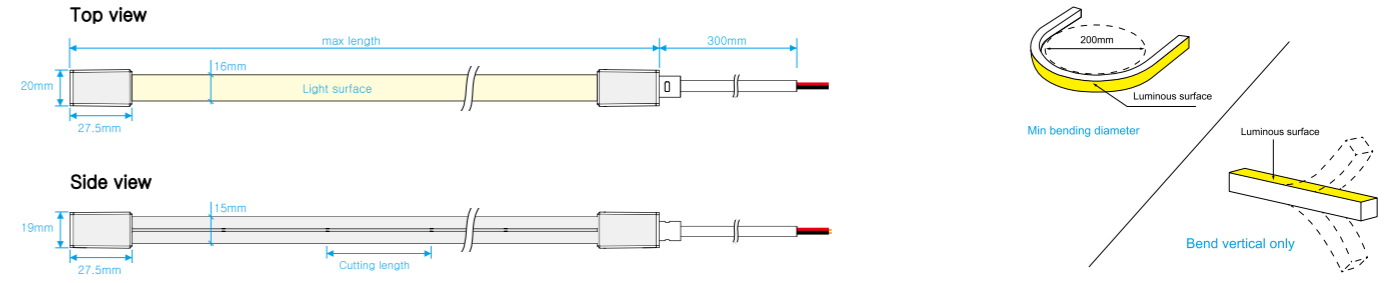

## 規格參數

|        |            |
|--------|------------|
| 輸入電壓   | DC24 V     |
| 演色性/Ra | >90        |
| 環境溫度   | -25°C~45°C |

## 配光曲線

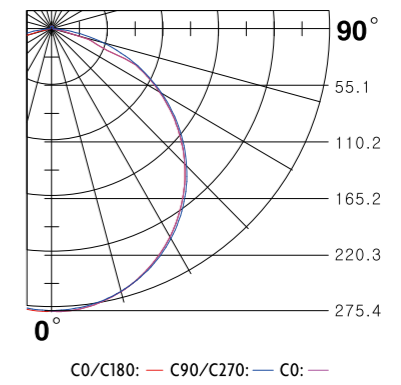

# 正發光 T1420 NEON

線性照明方案



## 尺寸

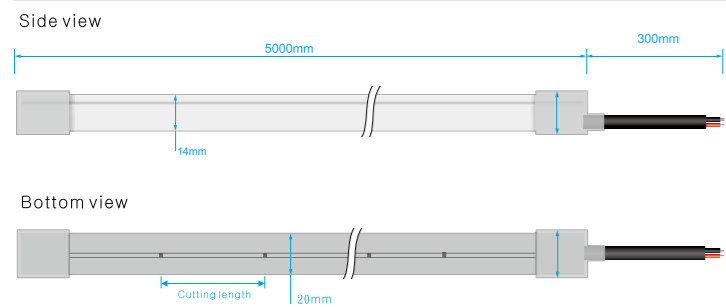

## 規格參數

|        |            |
|--------|------------|
| 輸入電壓   | DC24 V     |
| 演色性/Ra | >90        |
| 環境溫度   | -25°C~45°C |

## 配光曲線

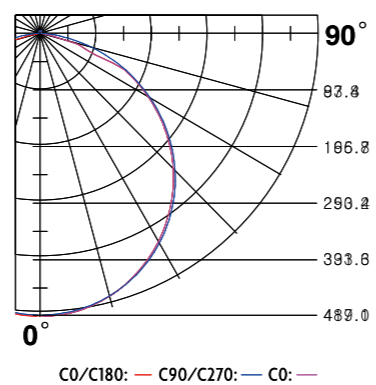

# 正發光 T1420 NEON 三面光

線性照明方案

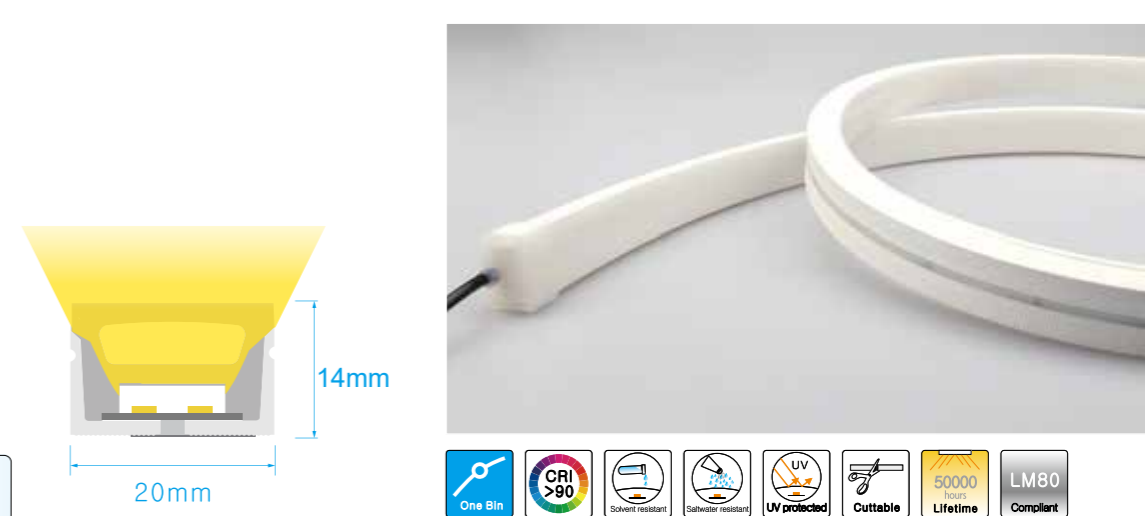

## 尺寸

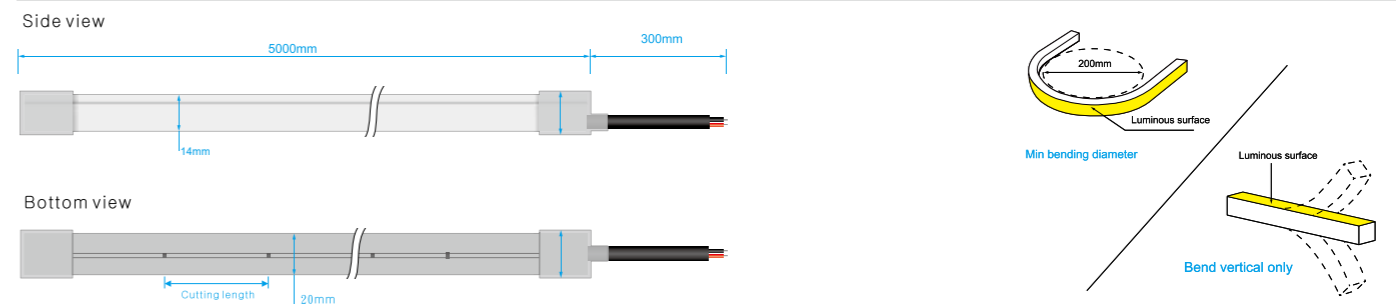

## 規格參數

|        |            |
|--------|------------|
| 輸入電壓   | DC24 V     |
| 演色性/Ra | >90        |
| 環境溫度   | -25°C~45°C |

## 配光曲線

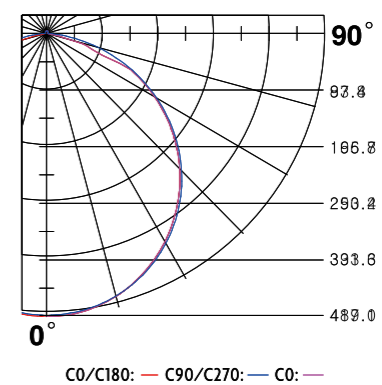

# 正發光 T1620 NEON

線性照明方案

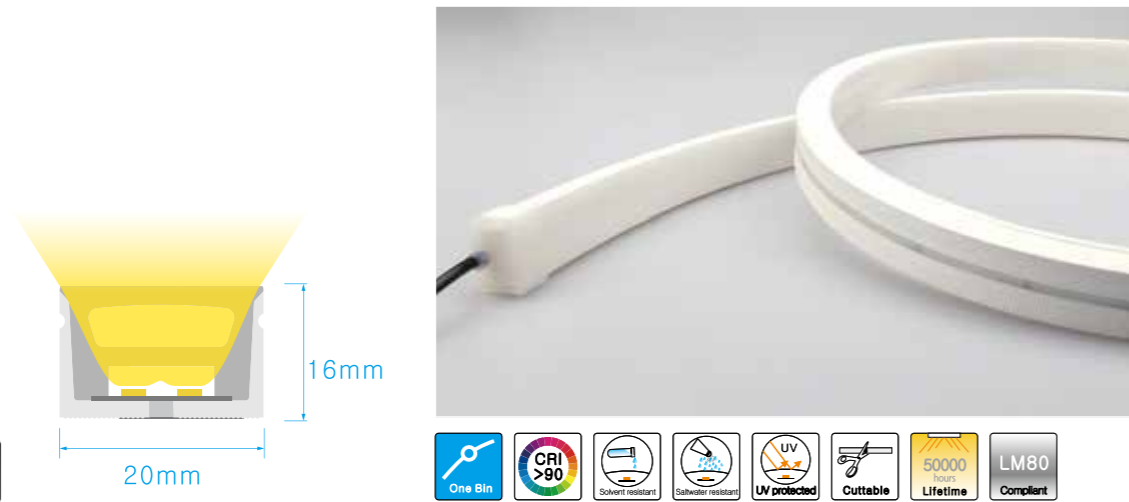

3000K - 6000K



## 尺寸

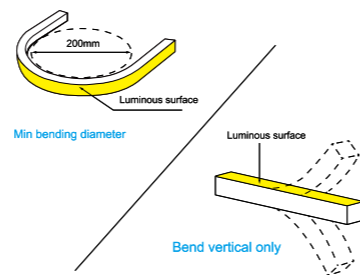
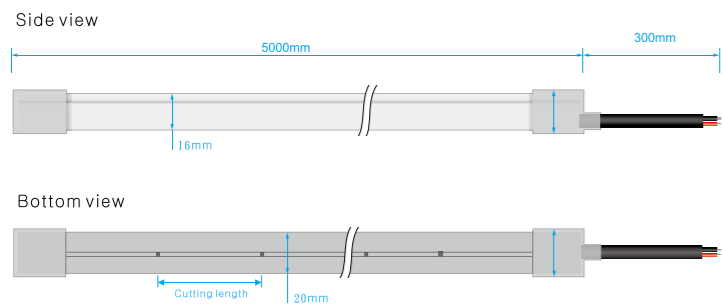

## 規格參數

|        |            |
|--------|------------|
| 輸入電壓   | DC24 V     |
| 演色性/Ra | >90        |
| 環境溫度   | -25°C~45°C |

## 配光曲線

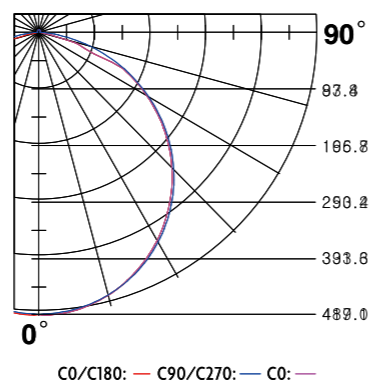

# 正發光 T2020 NEON

線性照明方案

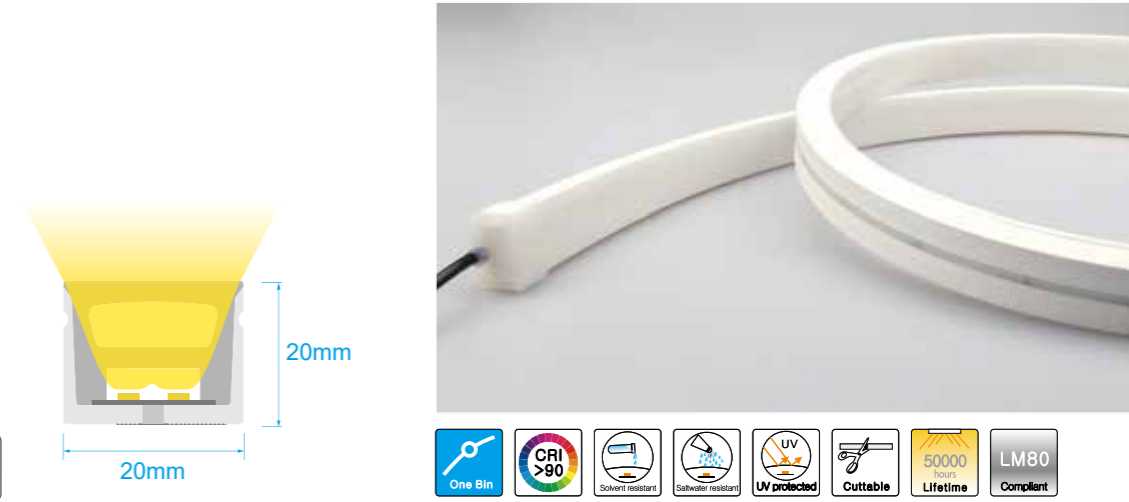

3000K - 6000K

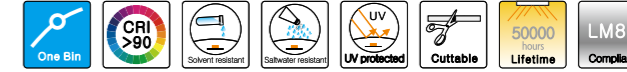

## 尺寸

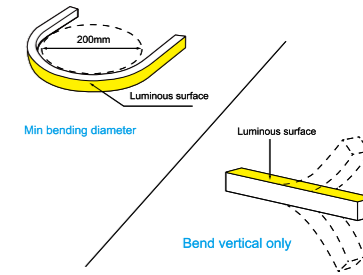
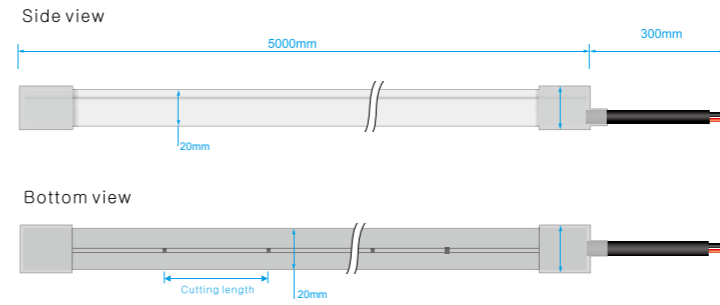

## 規格參數

|        |            |
|--------|------------|
| 輸入電壓   | DC24 V     |
| 演色性/Ra | >90        |
| 環境溫度   | -25°C~45°C |

## 配光曲線

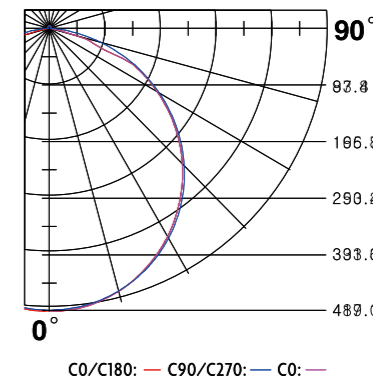

# 正發光

## T3020 NEON

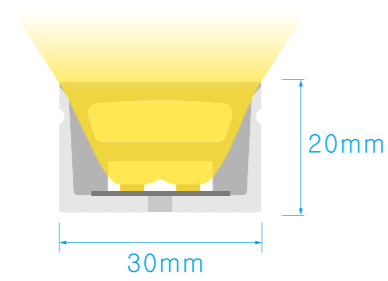

3000K - 6000K



### 尺寸

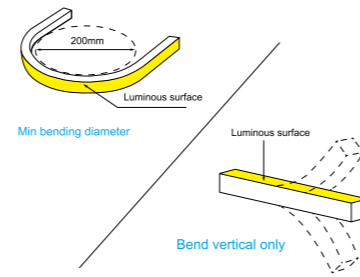
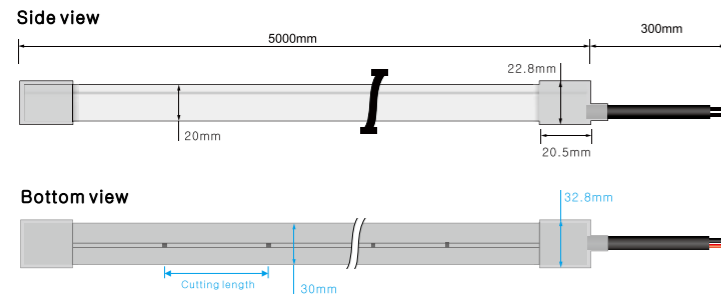

### 規格參數

|        |            |
|--------|------------|
| 輸入電壓   | DC24 V     |
| 演色性/Ra | >90        |
| 環境溫度   | -25°C~45°C |

### 配光曲線

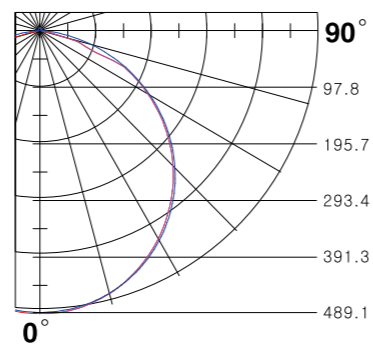

C0/C180: — C90/C270: — C0: —

# 正發光

## T4025 NEON

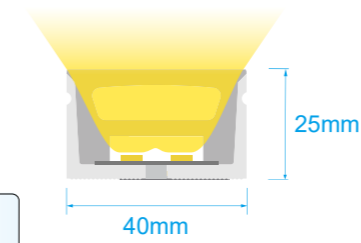

3000K - 6000K



### 尺寸

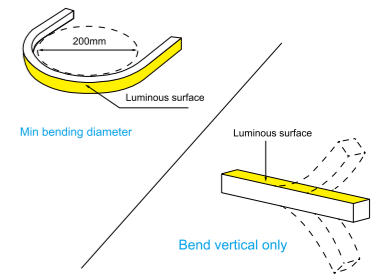
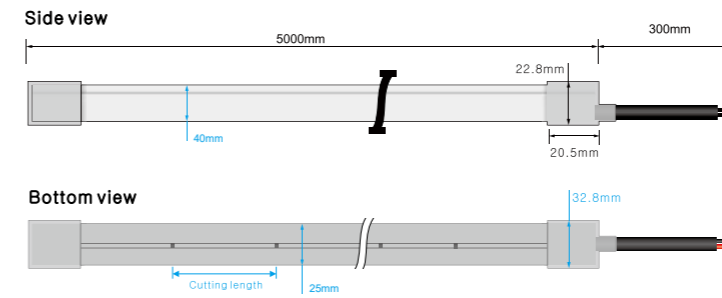

### 規格參數

|        |            |
|--------|------------|
| 輸入電壓   | DC24 V     |
| 演色性/Ra | >90        |
| 環境溫度   | -25°C~45°C |

### 配光曲線

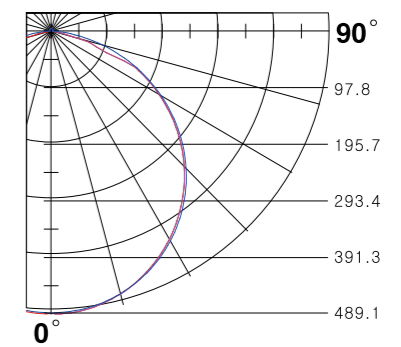

C0/C180: — C90/C270: — C0: —

# 正發光 T5025 NEON

線性照明方案

線性照明方案

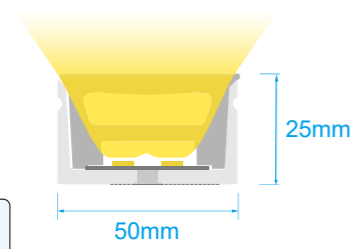

3000K - 6000K



## 尺寸

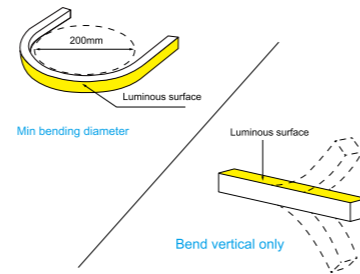
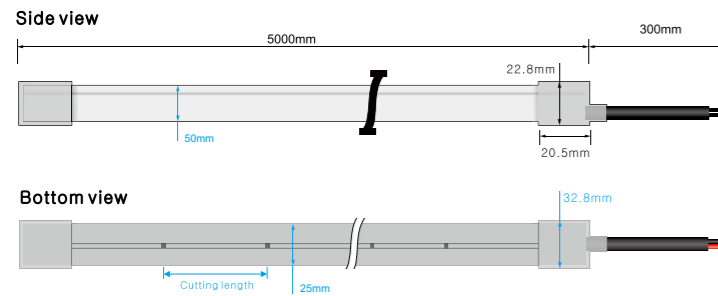

## 規格參數

|        |            |
|--------|------------|
| 輸入電壓   | DC24 V     |
| 演色性/Ra | >90        |
| 環境溫度   | -25°C~45°C |

## 配光曲線

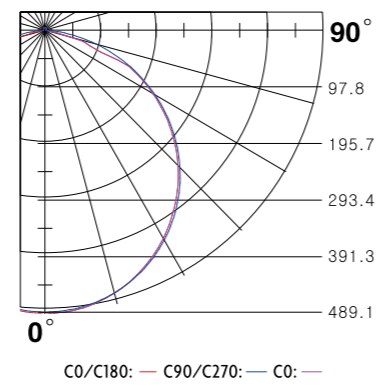

# 矽膠霓虹燈帶

## 特殊外型應用

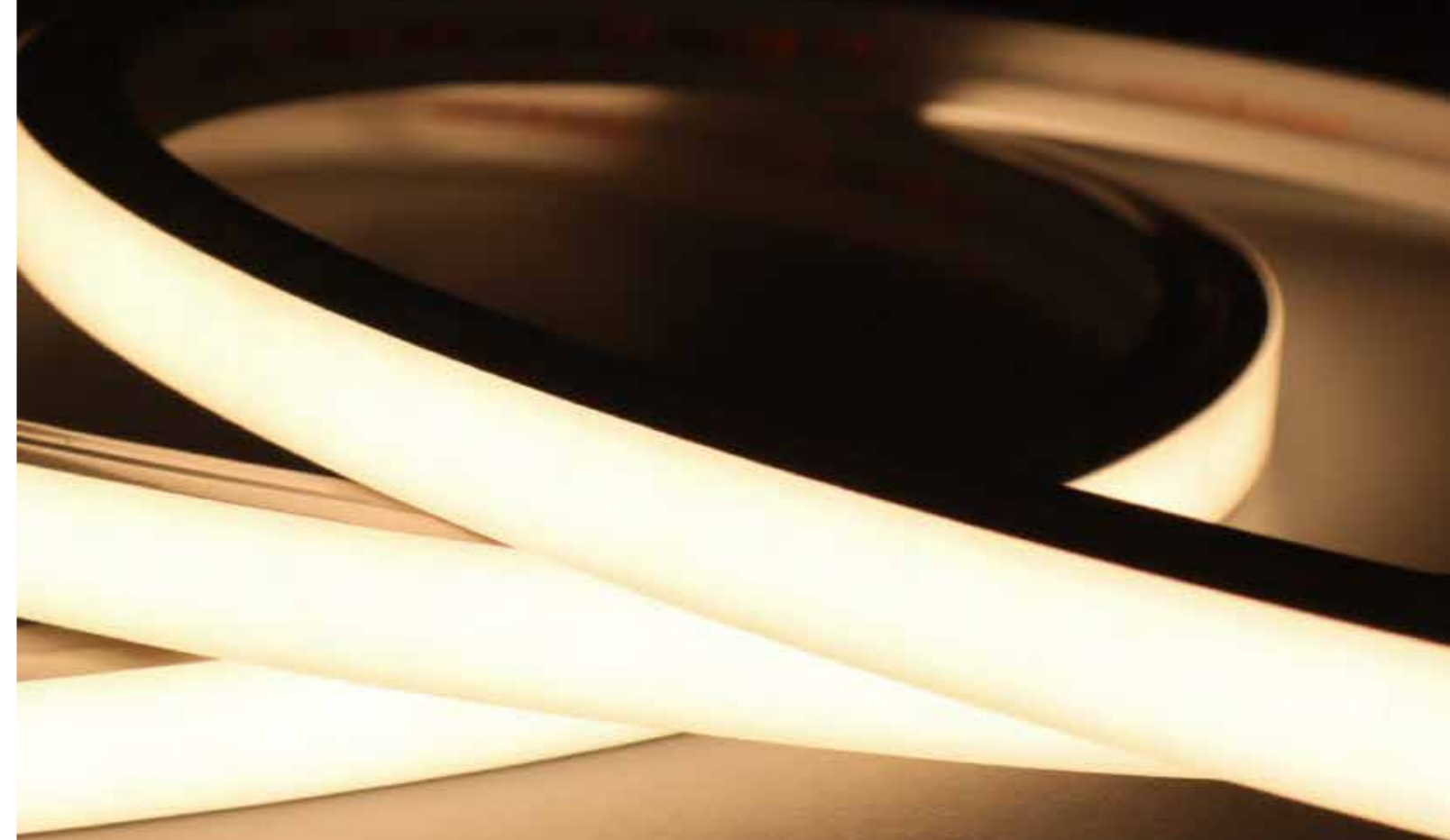



# 正發光 T2016 NEON



3000K - 6000K

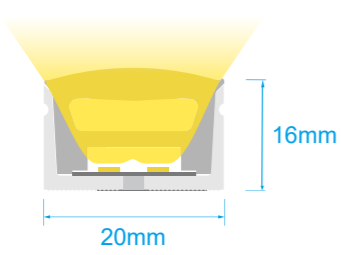

## 尺寸

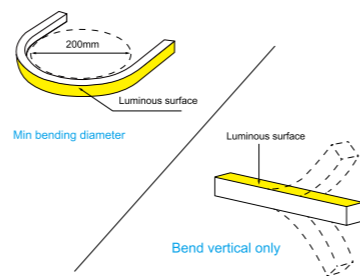
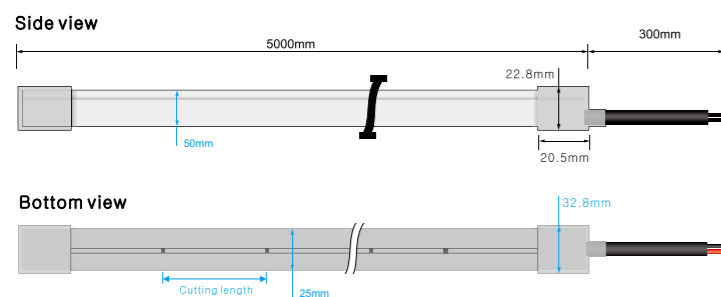

## 規格參數

|        |            |
|--------|------------|
| 輸入電壓   | DC24 V     |
| 演色性/Ra | >90        |
| 環境溫度   | -25°C~45°C |

## 配光曲線

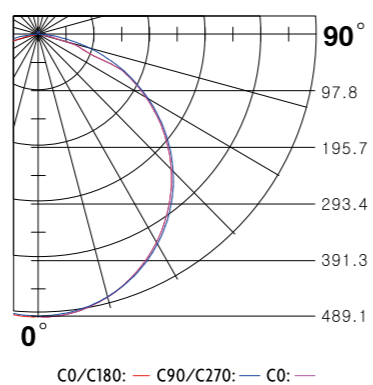

# 正發光 S1620 NEON

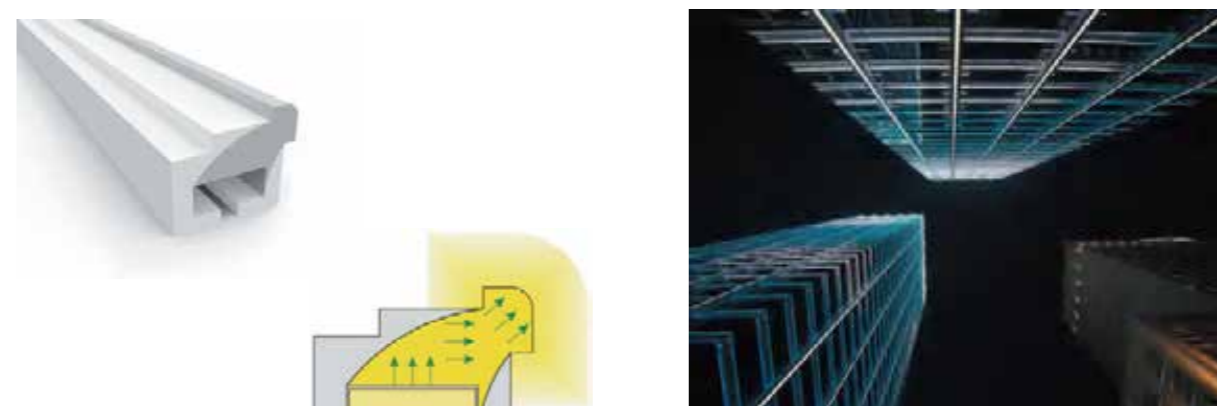

3000K - 6000K

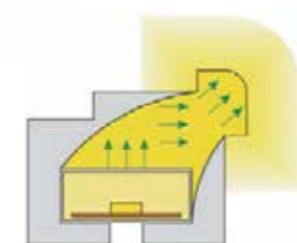

## 尺寸

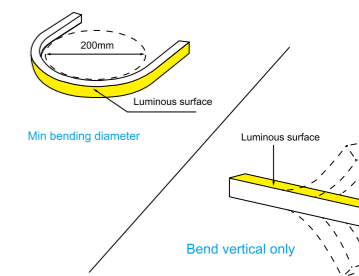
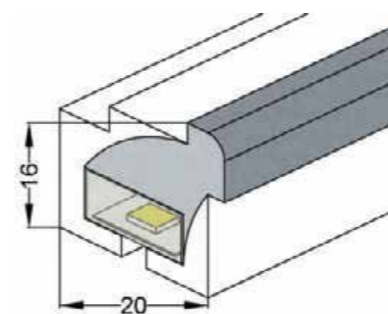

## 規格參數

|        |            |
|--------|------------|
| 輸入電壓   | DC24 V     |
| 演色性/Ra | >90        |
| 環境溫度   | -25°C~45°C |

## 配光曲線

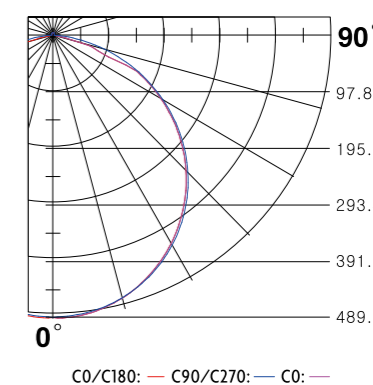

# 正發光 T1723 NEON



3000K - 6000K

尺寸

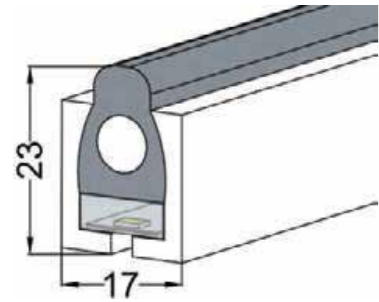

規格參數

|        |            |
|--------|------------|
| 輸入電壓   | DC24V      |
| 演色性/Ra | >90        |
| 環境溫度   | -25°C~45°C |

配光曲線

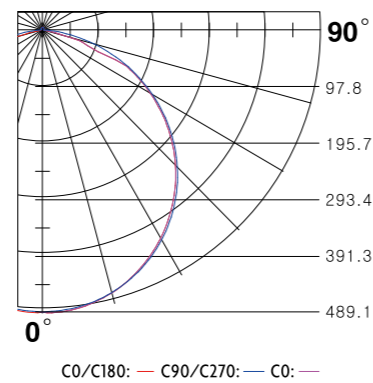

# 正發光 S1525 NEON



3000K - 6000K

尺寸

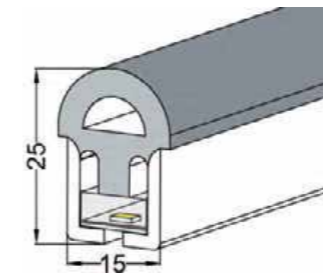

規格參數

|        |            |
|--------|------------|
| 輸入電壓   | DC24V      |
| 演色性/Ra | >90        |
| 環境溫度   | -25°C~45°C |

配光曲線

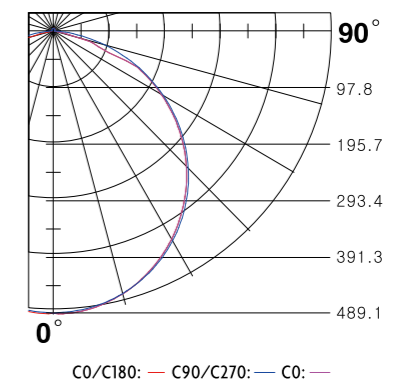

# 正發光 S1315 NEON



3000K - 6000K

尺寸

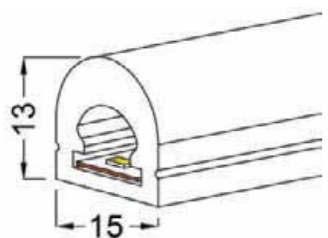

## 規格參數

|        |            |
|--------|------------|
| 輸入電壓   | DC24 V     |
| 演色性/Ra | >90        |
| 環境溫度   | -25°C~45°C |

## 配光曲線

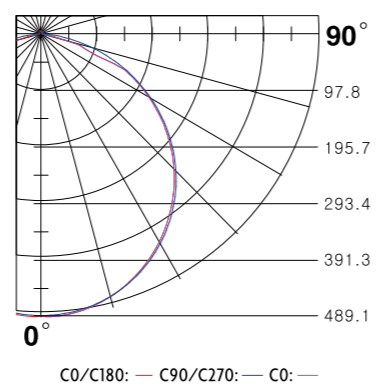

# 正發光 S1313 NEON



3000K - 6000K

尺寸

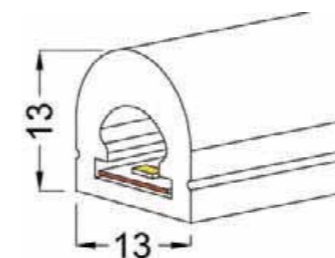

## 規格參數

|        |            |
|--------|------------|
| 輸入電壓   | DC24 V     |
| 演色性/Ra | >90        |
| 環境溫度   | -25°C~45°C |

## 配光曲線

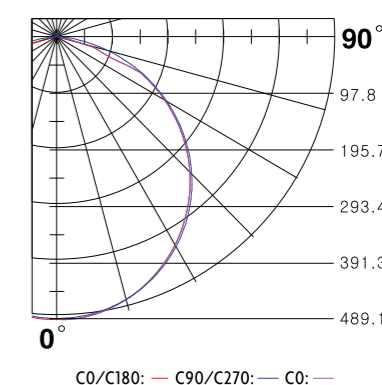

# 全發光 $\phi 13(\text{mm})360^\circ$ NEON



3000K - 6000K

尺寸

Regular product size

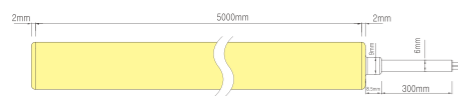

Hanging product size

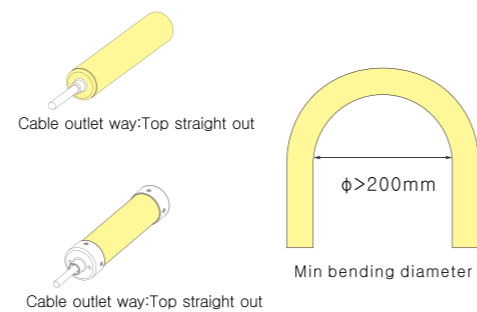
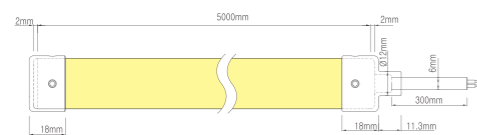

配光曲線

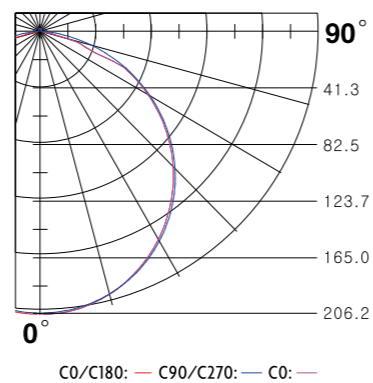

規格參數

|        |            |
|--------|------------|
| 輸入電壓   | DC24 V     |
| 演色性/Ra | >90        |
| 環境溫度   | -25°C~45°C |

# 全發光 $\phi 22(\text{mm})360^\circ$

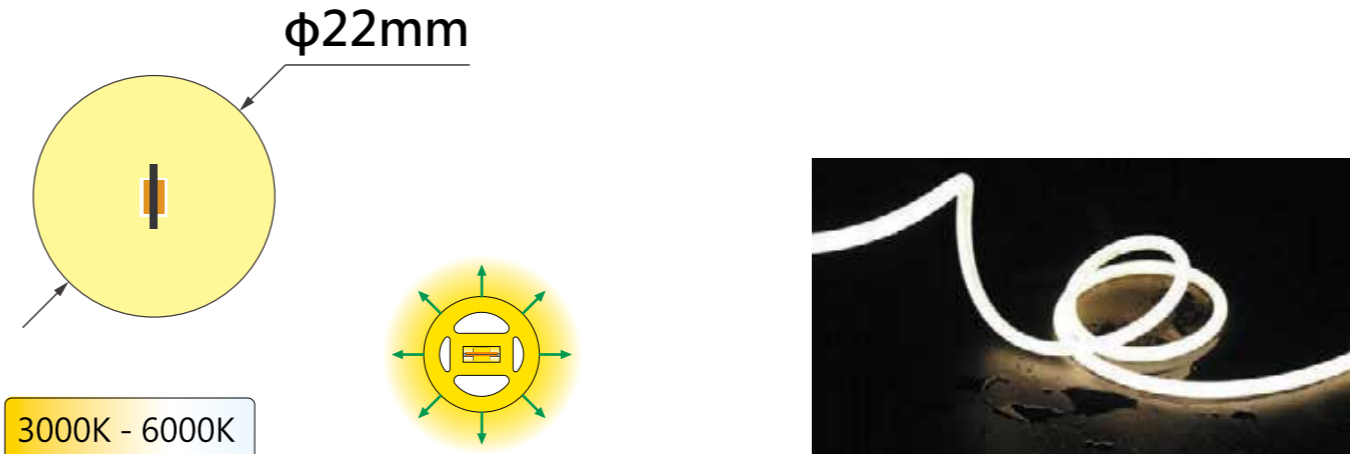

3000K - 6000K

尺寸

Regular product size



Hanging product size

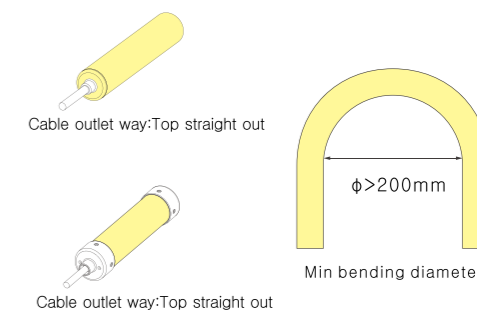
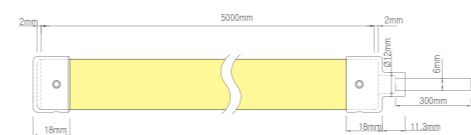

配光曲線

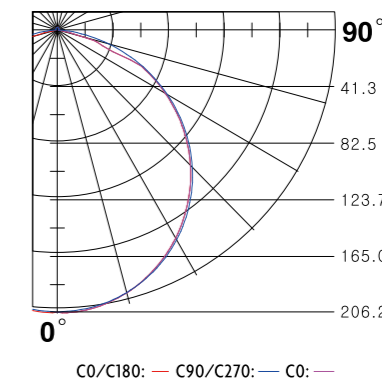

規格參數

|        |            |
|--------|------------|
| 輸入電壓   | DC24 V     |
| 演色性/Ra | >90        |
| 環境溫度   | -25°C~45°C |

# 全發光 $\phi 25(\text{mm})360^\circ$

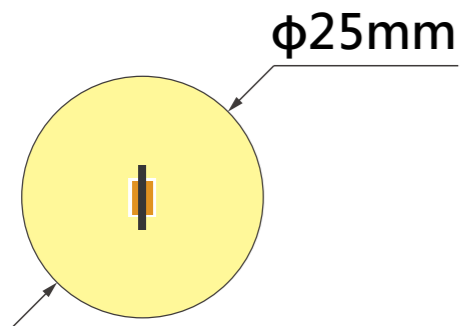

一體成形，無法出廠後剪裁



## 尺寸

### Regular product size



### Hanging product size

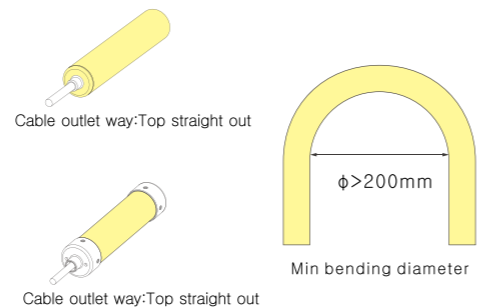
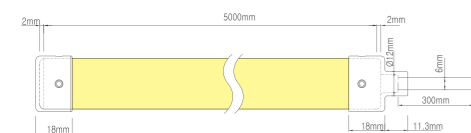

## 規格參數

|        |            |
|--------|------------|
| 輸入電壓   | DC24 V     |
| 演色性/Ra | >90        |
| 環境溫度   | -25°C~45°C |

## 配光曲線

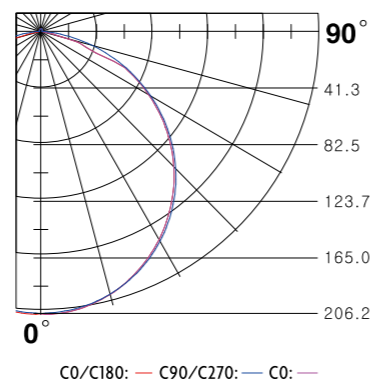

# 全發光 $\phi 40(\text{mm})360^\circ$

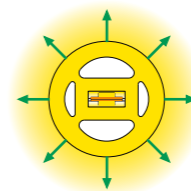
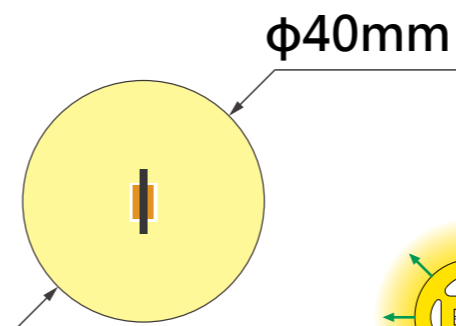

3000K - 6000K



## 尺寸

### Regular product size



### Hanging product size

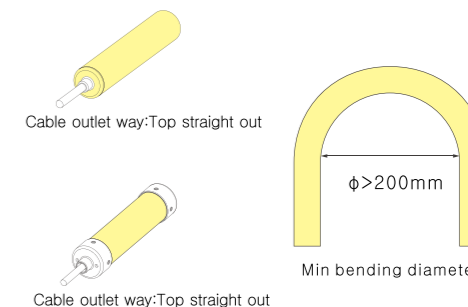
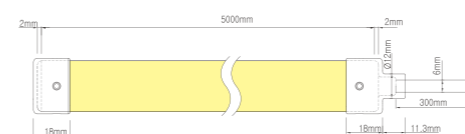

## 規格參數

|        |            |
|--------|------------|
| 輸入電壓   | DC24 V     |
| 演色性/Ra | >90        |
| 環境溫度   | -25°C~45°C |

## 配光曲線

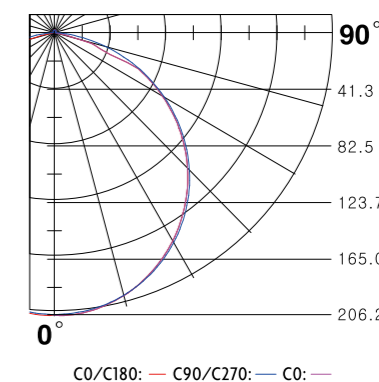

# 全發光 $\phi 20(\text{mm})360^\circ$

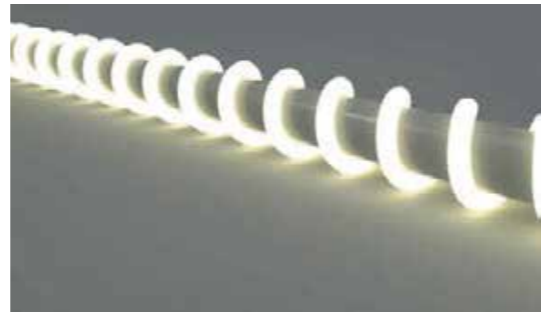
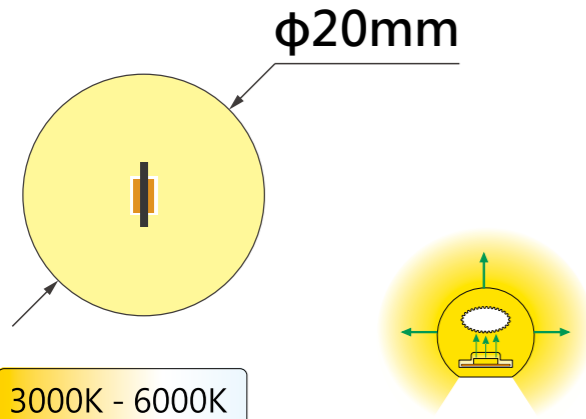

## 尺寸

Regular product size

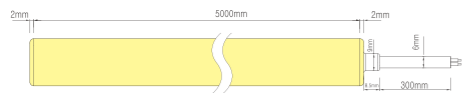

Hanging product size

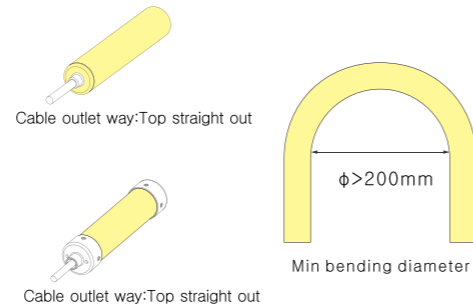
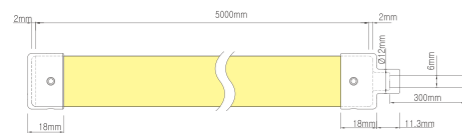

## 規格參數

|        |            |
|--------|------------|
| 輸入電壓   | DC24 V     |
| 演色性/Ra | >90        |
| 環境溫度   | -25°C~45°C |

## 配光曲線

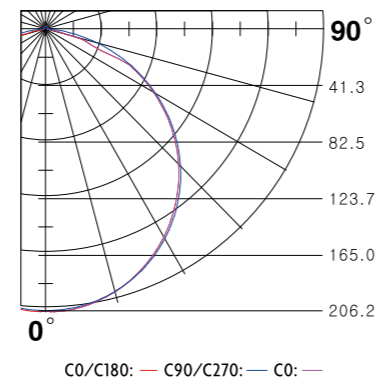

# PU 水下型 NEON

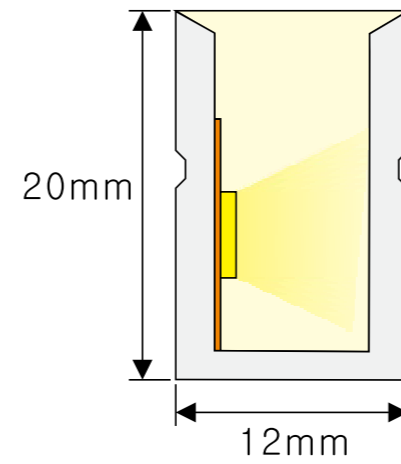

## 尺寸

Side view

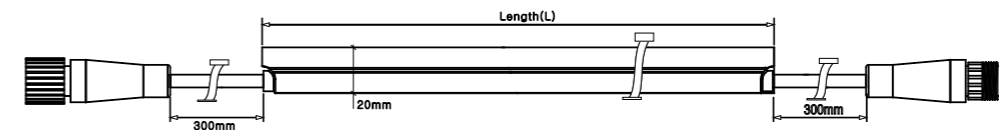

Top view

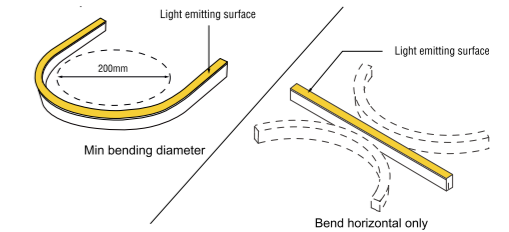
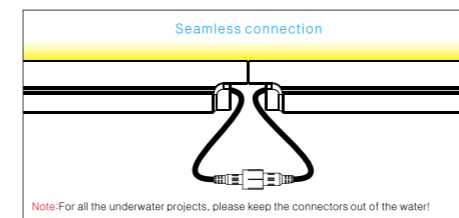
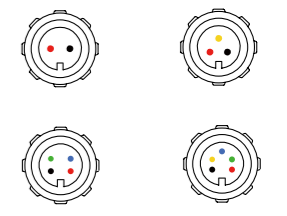
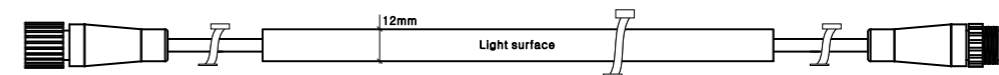

## 注意事項

### 尺寸訂制範圍

Single color:  $L_{\text{min}}=152.1\pm 11\text{mm}$ ;  $L_{\text{max}}=5027\pm 19\text{mm}$ ; in 41.7mm increments  
 Tunable color:  $L_{\text{min}}=177\pm 11\text{mm}$ ;  $L_{\text{max}}=5027\pm 19\text{mm}$ ; in 50mm increments  
 RGB/RGBW:  $L_{\text{min}}=241.29\pm 11\text{mm}$ ;  $L_{\text{max}}=5027\pm 19\text{mm}$ ; in 71.43mm increments

|        |            |
|--------|------------|
| 輸入電壓   | DC24 V     |
| 演色性/Ra | >80        |
| 環境溫度   | -25°C~60°C |

# SKYLINE LINEAR LIGHT

天際線 線性照明





選用2835燈帶 / 24V  
燈帶長度 10公尺  
最小剪裁 1公分

燈具外型圖  
Dimension drawing

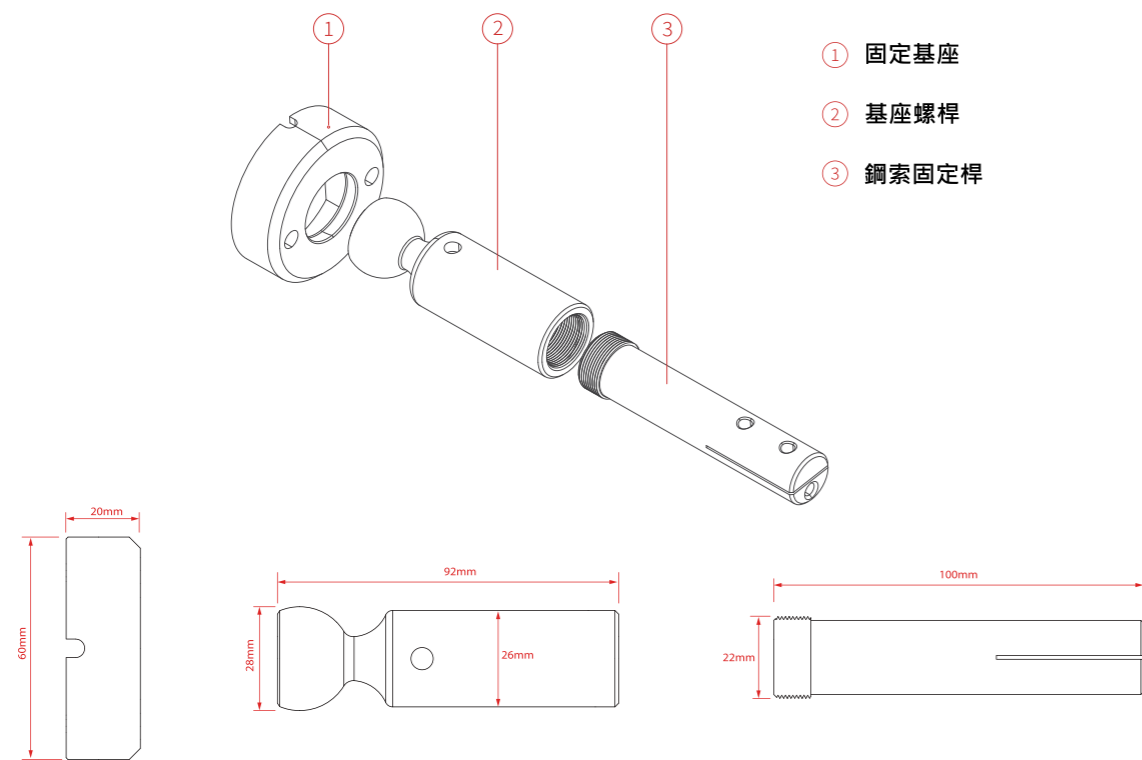

accessories



① 鋼片  
SY-SC10



工具包  
TOOL KIT



安裝說明

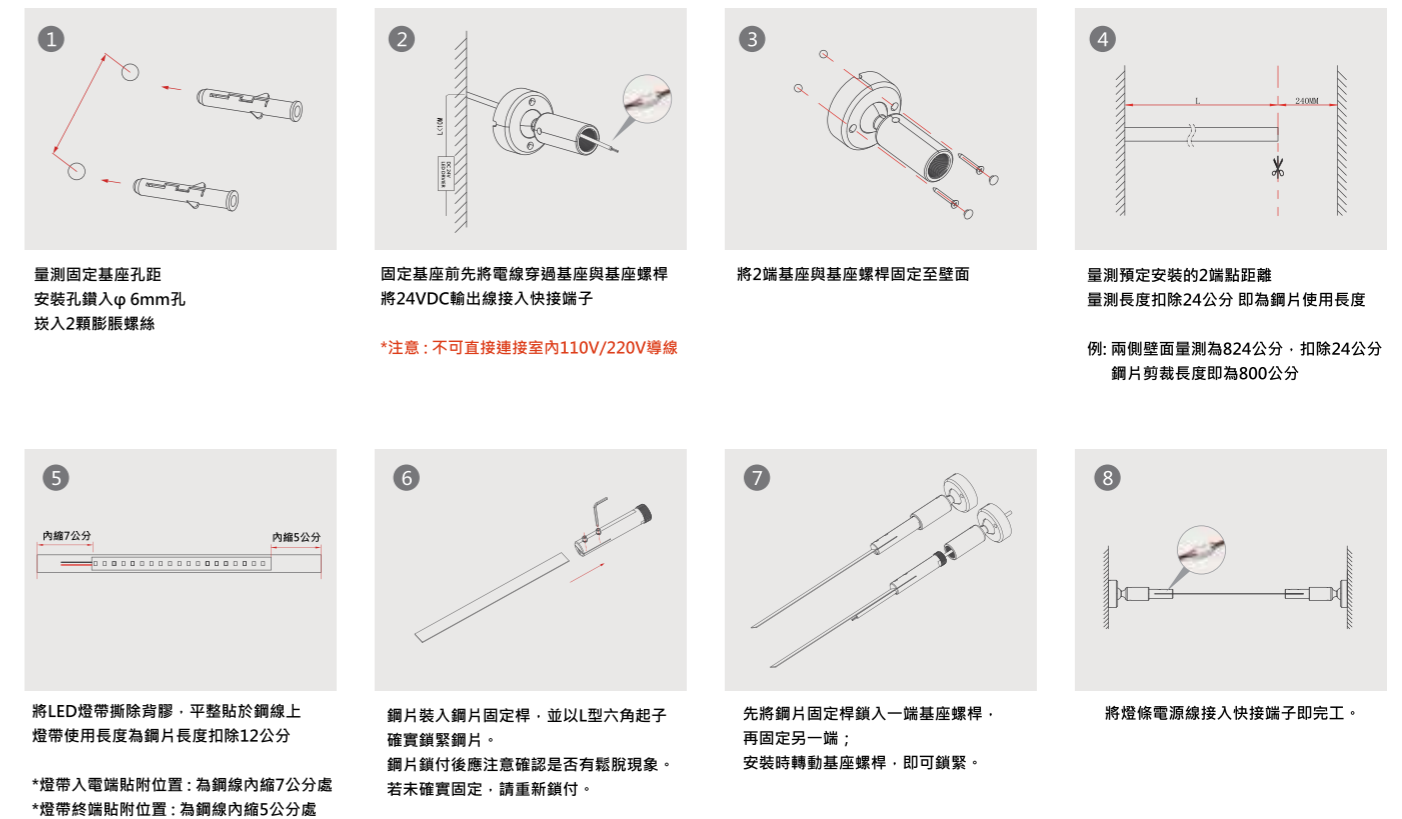



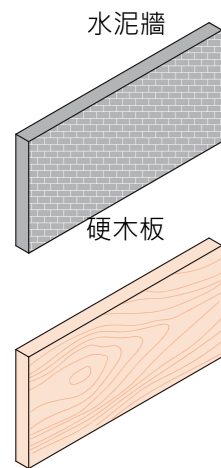
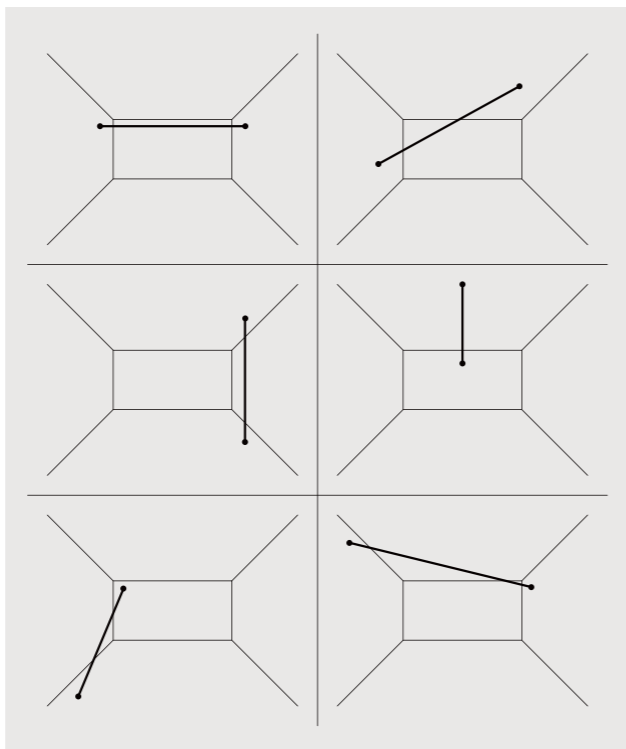
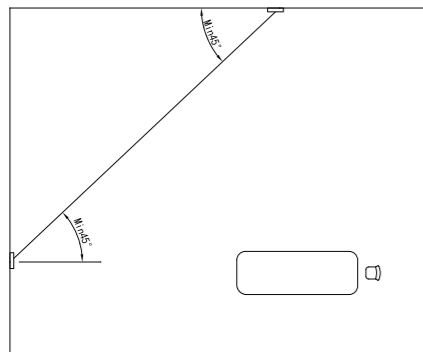
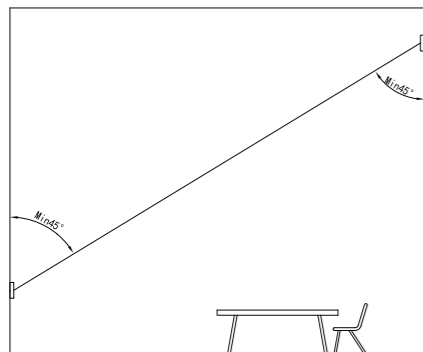

DC 24V  
LED DRIVER

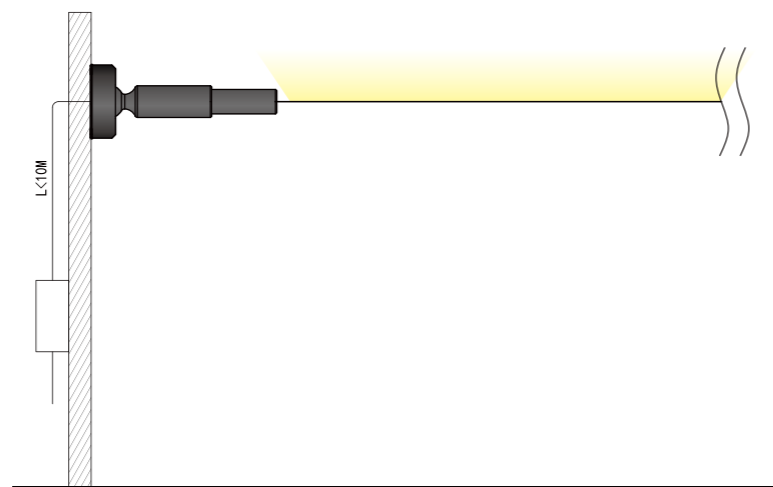

**注意**

1. 安裝面須為堅固表面，如硬木板、水泥牆、磚牆等；請勿安裝於石膏牆或中空牆面等無法牢固鎖付的材質。
2. 安裝或剪裁鋼片時，請穿著護目鏡、工作手套等護具。鋼片具彈性，安裝或拆卸時，慎防彈出割傷。

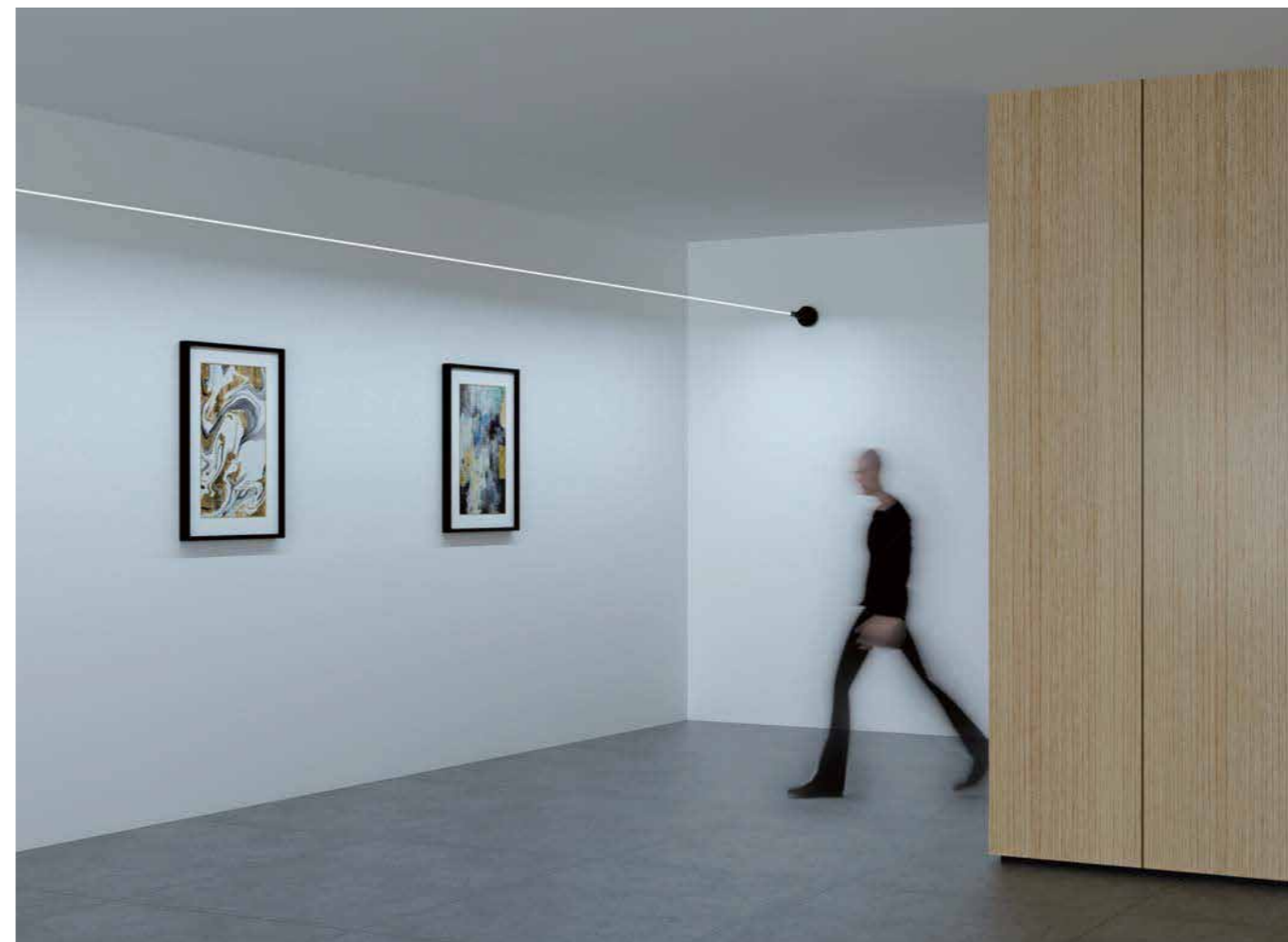

## SY-8131-3

- 應用各種間照設計
- 鋁壓鑄成型
- 高演色性光源
- 防眩設計

適用光源：LED MR16 6W

### ◆ 材質參數 MATERIAL DESCRIPTION

|      |      |
|------|------|
| 材質   | 金屬   |
| 表面處理 | 表面烤漆 |
| 外框顏色 | 白色   |

### ◆ 規格參數 SPECIFICATION

| 參數   | FIXTURE PROFILE |
|------|-----------------|
| 尺寸   | W105 x H35mm    |
| 光源數  | LED MR16 *1     |
| 燈具嵌孔 | ⌀95mm           |

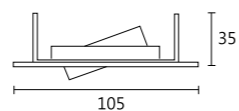

單位：mm

### ◆ 光源配備 OPTIONAL LAMP

| MR16光源 | LED MR16          |
|--------|-------------------|
|        | 3000K、4000K、6500K |

## SY-8154-1

- 應用各種間照設計
- 鋁壓鑄成型
- 高演色性光源
- 防眩設計

適用光源：COB 7.5W模組

### ◆ 材質參數 MATERIAL DESCRIPTION

|      |      |
|------|------|
| 材質   | 金屬   |
| 表面處理 | 表面烤漆 |
| 外框顏色 | 黑色   |

### ◆ 規格參數 SPECIFICATION

| 參數   | FIXTURE PROFILE |
|------|-----------------|
| 尺寸   | W76xH40mm       |
| 光源數  | LED MR16 *1     |
| 燈具嵌孔 | ⌀58mm           |

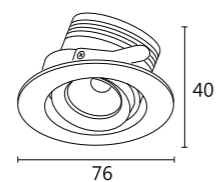

單位：mm

### ◆ 光源配備 OPTIONAL LAMP

| COB光源 | LED COB MODULE    |
|-------|-------------------|
|       | 3000K、4000K、5000K |

## SY-8139-2

- 應用各種間照設計
- 鋁壓鑄成型
- 高演色性光源
- 防眩設計

適用光源：LED MR16 6W

### ◆ 材質參數 MATERIAL DESCRIPTION

|      |      |
|------|------|
| 材質   | 金屬   |
| 表面處理 | 表面烤漆 |
| 外框顏色 | 白色   |

### ◆ 規格參數 SPECIFICATION

| 參數   | FIXTURE PROFILE |
|------|-----------------|
| 尺寸   | W80xH95mm       |
| 光源數  | LED MR16 *1     |
| 燈具嵌孔 | ⌀75mm           |

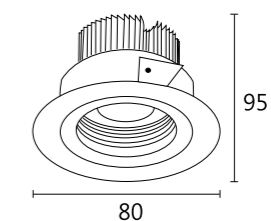

單位：mm

### ◆ 光源配備 OPTIONAL LAMP

| MR16光源 | LED MR16          |
|--------|-------------------|
|        | 3000K、4000K、6500K |

## SY-8154-2

- 應用各種間照設計
- 鋁壓鑄成型
- 高演色性光源
- 防眩設計

適用光源：COB 7.5W模組

### ◆ 材質參數 MATERIAL DESCRIPTION

|      |      |
|------|------|
| 材質   | 金屬   |
| 表面處理 | 表面烤漆 |
| 外框顏色 | 白色   |

### ◆ 規格參數 SPECIFICATION

| 參數   | FIXTURE PROFILE |
|------|-----------------|
| 尺寸   | W76xH40mm       |
| 光源數  | LED COB模組       |
| 燈具嵌孔 | ⌀58mm           |

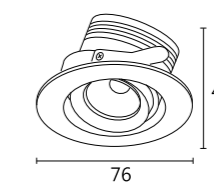

單位：mm

### ◆ 光源配備 OPTIONAL LAMP

| COB 模組 | LED COB MODULE    |
|--------|-------------------|
|        | 3000K、4000K、5000K |

## SY-8131-1

- 應用各種間照設計
- 鋁壓鑄成型
- 高演色性光源
- 防眩設計

適用光源：LED MR16 6W

### ◆ 材質參數 MATERIAL DESCRIPTION

|      |      |
|------|------|
| 材質   | 金屬   |
| 表面處理 | 表面烤漆 |
| 外框顏色 | 白色   |



單位：mm

### ◆ 規格參數 SPECIFICATION

| 參數   | FIXTURE PROFILE |
|------|-----------------|
| 尺寸   | W90xH95mm       |
| 光源數  | LED MR16 *1     |
| 燈具嵌孔 | ⌀80mm           |

### ◆ 光源配備 OPTIONAL LAMP

| MR16光源 | LED MR16          |
|--------|-------------------|
|        | 3000K、4000K、6500K |



## SY-8131-2

- 應用各種間照設計
- 鋁壓鑄成型
- 高演色性光源
- 防眩設計

適用光源：LED MR16 6W

### ◆ 材質參數 MATERIAL DESCRIPTION

|      |      |
|------|------|
| 材質   | 金屬   |
| 表面處理 | 表面烤漆 |
| 外框顏色 | 白色   |

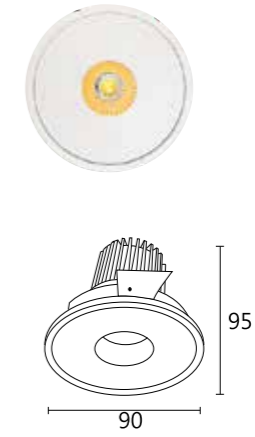

單位：mm

### ◆ 規格參數 SPECIFICATION

| 參數   | FIXTURE PROFILE |
|------|-----------------|
| 尺寸   | W90xH95mm       |
| 光源數  | LED MR16 *1     |
| 燈具嵌孔 | ⌀80mm           |

### ◆ 光源配備 OPTIONAL LAMP

| MR16光源 | LED MR16          |
|--------|-------------------|
|        | 3000K、4000K、6500K |



## SY-8009-1

- 應用各種間照設計
- 鐵框 鋼材沖壓一體成型
- 高演色性 CRI90 COB光源
- 簡易嵌入安裝

適用光源：LED AR111 42W / 32W / 22W / 12W

### ◆ 材質參數 MATERIAL DESCRIPTION

|      |      |
|------|------|
| 材質   | 金屬   |
| 表面處理 | 表面烤漆 |
| 外框顏色 | 白色   |
| 內框顏色 | 黑色   |

### ◆ 規格參數 SPECIFICATION

| 參數   | FIXTURE PROFILE  |
|------|------------------|
| 尺寸   | L482xW182xH150mm |
| 光源數  | LED AR111 *3     |
| 燈具嵌孔 | 160x460mm        |

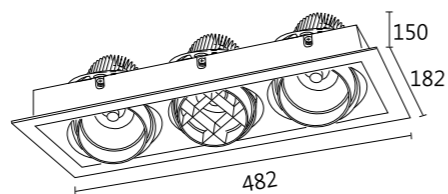

單位：mm

### ◆ 光源配備 OPTIONAL LAMP

| COB光源模組   | LED COB MODULE  |
|---|---|
|    |   |
|  |  |
| AR111 COB 42W   | AR111 COB 32W   |
| AR111 COB 22W   | AR111 COB 12W   |

## SY-8009-3

- 應用各種間照設計
- 出光均勻
- 高演色性 CRI90 COB光源
- 簡易嵌入安裝

適用光源：LED AR111 42W / 32W / 22W / 12W

### ◆ 材質參數 MATERIAL DESCRIPTION

|      |      |
|------|------|
| 材質   | 金屬   |
| 表面處理 | 表面烤漆 |
| 外框顏色 | 白色   |
| 內框顏色 | 黑色   |

### ◆ 規格參數 SPECIFICATION

| 參數   | FIXTURE PROFILE  |
|------|------------------|
| 尺寸   | L182xW182xH150mm |
| 光源數  | LED AR111 *1     |
| 燈具嵌孔 | 160x160mm        |

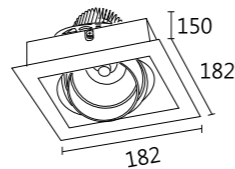

單位：mm

### ◆ 光源配備 OPTIONAL LAMP

| COB光源模組   | LED COB MODULE  |
|---|---|
|    |   |
|  |  |
| AR111 COB 42W   | AR111 COB 32W   |
| AR111 COB 22W   | AR111 COB 12W   |

## SY-8009-2

- 應用各種間照設計
- 鐵框 鋼材沖壓一體成型
- 高演色性 CRI90 COB光源
- 簡易嵌入安裝

適用光源：LED AR111 42W / 32W / 22W / 12W

### ◆ 材質參數 MATERIAL DESCRIPTION

|      |      |
|------|------|
| 材質   | 金屬   |
| 表面處理 | 表面烤漆 |
| 外框顏色 | 白色   |
| 內框顏色 | 黑色   |

### ◆ 規格參數 SPECIFICATION

| 參數   | FIXTURE PROFILE  |
|------|------------------|
| 尺寸   | L332xW182xH150mm |
| 光源數  | LED AR111 *2     |
| 燈具嵌孔 | 160x310mm        |

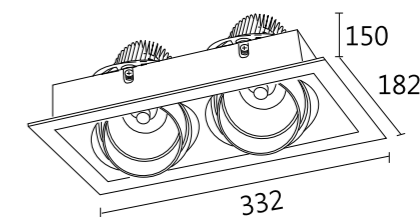

單位：mm

### ◆ 光源配備 OPTIONAL LAMP

| COB光源模組   | LED COB MODULE  |
|---|---|
|  |  |
|  |  |
| AR111 COB 42W   | AR111 COB 32W   |
| AR111 COB 22W   | AR111 COB 12W   |

## SY-8010-1

- 應用各種間照設計
- 鐵框 鋼材沖壓一體成型
- 高演色性 CRI90 COB光源
- 簡易嵌入安裝

適用光源：LED AR111 42W

### ◆ 材質參數 MATERIAL DESCRIPTION

|      |      |
|------|------|
| 材質   | 金屬   |
| 表面處理 | 表面烤漆 |
| 外框顏色 | 白色   |
| 內框顏色 | 黑色   |

### ◆ 規格參數 SPECIFICATION

| 參數   | FIXTURE PROFILE   |
|------|---|
| 尺寸   | L500xW180xH140mm  |
| 光源數  | LED AR111 *3  |
| 燈具嵌孔 |  160x475mm |

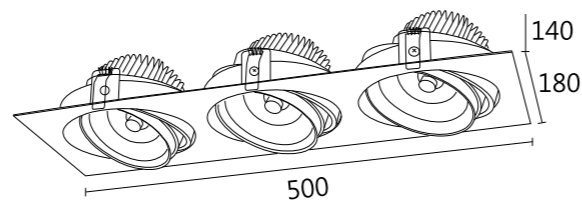

單位：mm

### ◆ 光源配備 OPTIONAL LAMP

| COB光源模組 | LED COB MODULE |
|---------|----------------|
|---------|----------------|



AR111 COB 42W

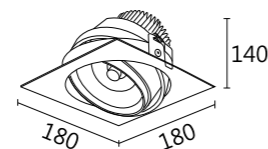

單位：mm

### ◆ 光源配備 OPTIONAL LAMP

| COB光源模組 | LED COB MODULE |
|---------|----------------|
|---------|----------------|



AR111 COB 42W



AR111 COB 32W



AR111 COB 22W



AR111 COB 12W

## SY-8011-1

- 應用各種間照設計
- 鐵框 鋼材沖壓一體成型
- 高演色性 CRI90 COB光源
- 簡易嵌入安裝

適用光源：LED AR111 42W / 32W / 22W / 12W

### ◆ 材質參數 MATERIAL DESCRIPTION

|      |      |
|------|------|
| 材質   | 金屬   |
| 表面處理 | 表面烤漆 |
| 外框顏色 | 白色   |
| 內框顏色 | 黑色   |

### ◆ 規格參數 SPECIFICATION

| 參數   | FIXTURE PROFILE   |
|------|---|
| 尺寸   | L340xW180xH140mm  |
| 光源數  | LED AR111 *2  |
| 燈具嵌孔 |  160x315mm |

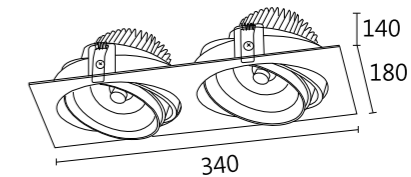

單位：mm

### ◆ 光源配備 OPTIONAL LAMP

| COB光源模組 | LED COB MODULE |
|---------|----------------|
|---------|----------------|



AR111 COB 42W



AR111 COB 32W



AR111 COB 22W



AR111 COB 12W

## SY-8011-2

- 應用各種間照設計
- 鐵框 鋼材沖壓一體成型
- 高演色性 CRI90 COB光源
- 簡易嵌入安裝

適用光源：LED AR111 42W / 32W / 22W / 12W

### ◆ 材質參數 MATERIAL DESCRIPTION

|      |      |
|------|------|
| 材質   | 金屬   |
| 表面處理 | 表面烤漆 |
| 外框顏色 | 白色   |
| 內框顏色 | 黑色   |

### ◆ 規格參數 SPECIFICATION

| 參數   | FIXTURE PROFILE   |
|------|---|
| 尺寸   | L180xW180xH140mm  |
| 光源數  | LED AR111 *1  |
| 燈具嵌孔 |  160x160mm |

## SY-8015-1

- 應用各種間照設計
- 鐵框 鋼材沖壓一體成型
- 高演色性 CRI90 COB光源
- 無邊框款式

適用光源：LED AR111 42W / 32W / 22W / 12W

## ◆ 材質參數 MATERIAL DESCRIPTION

|      |      |
|------|------|
| 材質   | 金屬   |
| 表面處理 | 表面烤漆 |
| 外框顏色 | 白色   |
| 內框顏色 | 黑色   |

## ◆ 規格參數 SPECIFICATION

| 參數   | FIXTURE PROFILE  |
|------|------------------|
| 尺寸   | L446xW149xH102mm |
| 光源數  | LED AR111 *3     |
| 燈具嵌孔 | 145x440mm        |

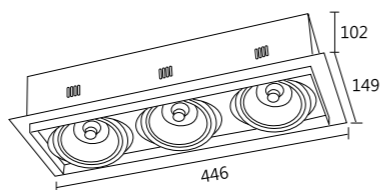

單位：mm

## ◆ 光源配備 OPTIONAL LAMP



## SY-8015-3

- 應用各種間照設計
- 出光均勻
- 高演色性 CRI90 COB光源
- 無邊框款式

適用光源：LED AR111 42W / 32W / 22W / 12W

## ◆ 材質參數 MATERIAL DESCRIPTION

|      |      |
|------|------|
| 材質   | 金屬   |
| 表面處理 | 表面烤漆 |
| 外框顏色 | 白色   |
| 內框顏色 | 黑色   |

## ◆ 規格參數 SPECIFICATION

| 參數   | FIXTURE PROFILE  |
|------|------------------|
| 尺寸   | L162xW149xH102mm |
| 光源數  | LED AR111 *1     |
| 燈具嵌孔 | 145x157mm        |

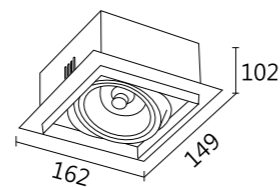

單位：mm

## ◆ 光源配備 OPTIONAL LAMP



## SY-8015-2

- 應用各種間照設計
- 鐵框 鋼材沖壓一體成型
- 高演色性 CRI90 COB光源
- 無邊框款式

適用光源：LED AR111 42W / 32W / 22W / 12W

## ◆ 材質參數 MATERIAL DESCRIPTION

|      |      |
|------|------|
| 材質   | 金屬   |
| 表面處理 | 表面烤漆 |
| 外框顏色 | 白色   |
| 內框顏色 | 黑色   |

## ◆ 規格參數 SPECIFICATION

| 參數   | FIXTURE PROFILE  |
|------|------------------|
| 尺寸   | L305xW149xH102mm |
| 光源數  | LED AR111 *2     |
| 燈具嵌孔 | 145x298mm        |

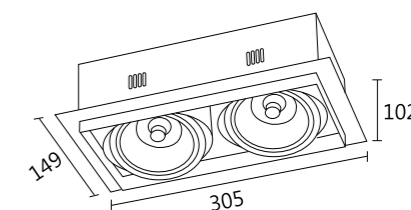

單位：mm

## ◆ 光源配備 OPTIONAL LAMP



## 無邊框安裝方式

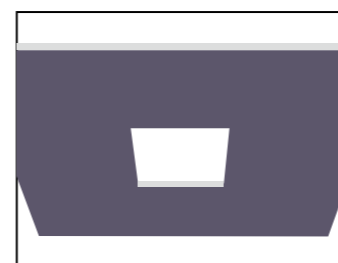

1. 準確開孔  
天花板須跟內框厚度相同



2. 對角放入內框

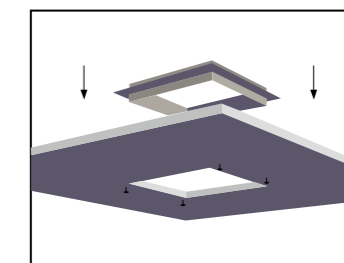

3. 往下壓平整

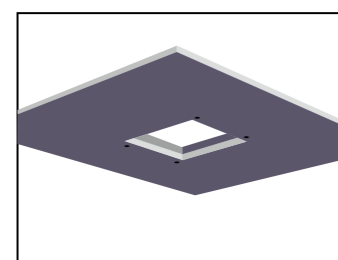

4. 固定內框

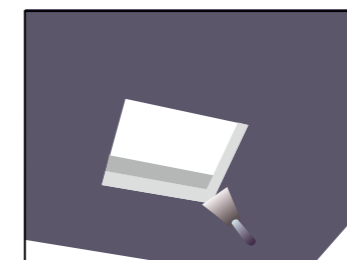

5. 修補縫隙

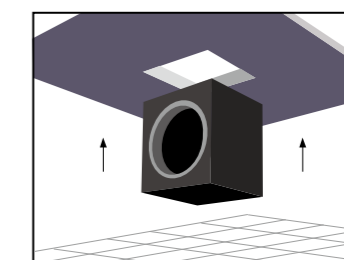

6. 放入燈具主體

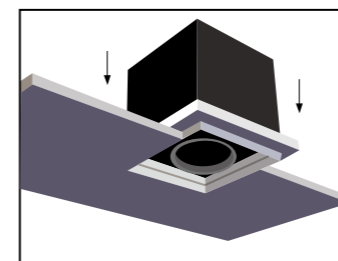

7. 燈具主體與內框結合

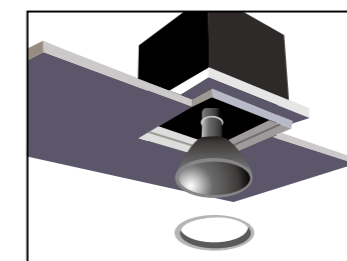

8. 旋下前罩裝入光源

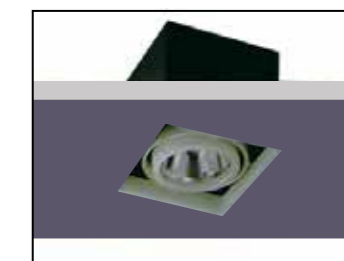

9. 完工示意圖

### SY-8016-1

- 應用各種間照設計
- 鐵框 鋼材沖壓一體成型
- 高演色性 CRI90 COB光源
- 無邊框款式

適用光源 : LED AR111 42W / 32W / 22W / 12W

#### ◆ 材質參數 MATERIAL DESCRIPTION

|      |      |
|------|------|
| 材質   | 金屬   |
| 表面處理 | 表面烤漆 |
| 外框顏色 | 白色   |
| 內框顏色 | 黑色   |

#### ◆ 規格參數 SPECIFICATION

| 參數   | FIXTURE PROFILE   |
|------|---|
| 尺寸   | L185xW185xH90mm   |
| 光源數  | LED AR111 *3  |
| 燈具嵌孔 |  165x165mm |

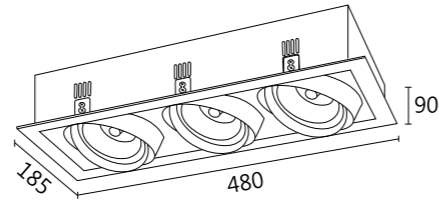

單位 : mm

#### ◆ 光源配備 OPTIONAL LAMP

| COB光源模組 | LED COB MODULE |
|---------|----------------|
|---------|----------------|



AR111 COB 12W

### SY-8016-3

- 應用各種間照設計
- 出光均勻
- 高演色性 CRI90 COB光源
- 無邊框款式

適用光源 : LED AR111 42W / 32W / 22W / 12W

#### ◆ 材質參數 MATERIAL DESCRIPTION

|      |      |
|------|------|
| 材質   | 金屬   |
| 表面處理 | 表面烤漆 |
| 外框顏色 | 白色   |
| 內框顏色 | 黑色   |

#### ◆ 規格參數 SPECIFICATION

| 參數   | FIXTURE PROFILE   |
|------|---|
| 尺寸   | L480xW185xH90mm   |
| 光源數  | LED AR111 *1  |
| 燈具嵌孔 |  160x450mm |

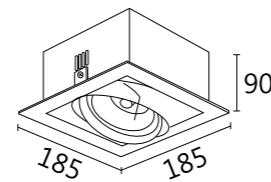

單位 : mm

#### ◆ 光源配備 OPTIONAL LAMP

| COB光源模組 | LED COB MODULE |
|---------|----------------|
|---------|----------------|



AR111 COB 12W

### SY-8016-2

- 應用各種間照設計
- 鐵框 鋼材沖壓一體成型
- 高演色性 CRI90 COB光源
- 無邊框款式

適用光源 : LED AR111 42W / 32W / 22W / 12W

#### ◆ 材質參數 MATERIAL DESCRIPTION

|      |      |
|------|------|
| 材質   | 金屬   |
| 表面處理 | 表面烤漆 |
| 外框顏色 | 白色   |
| 內框顏色 | 黑色   |

#### ◆ 規格參數 SPECIFICATION

| 參數   | FIXTURE PROFILE   |
|------|---|
| 尺寸   | L335xW185xH90mm   |
| 光源數  | LED AR111 *2  |
| 燈具嵌孔 |  160x310mm |

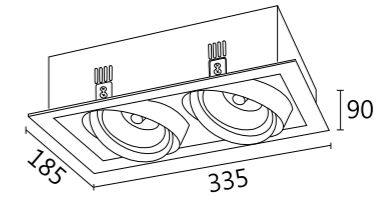

單位 : mm

#### ◆ 光源配備 OPTIONAL LAMP

| COB光源模組 | LED COB MODULE |
|---------|----------------|
|---------|----------------|



AR111 COB 12W



### SY-8017-1

- 應用各種間照設計
- 鐵框 鋼材沖壓一體成型
- 高演色性 CRI90 COB光源
- 無邊框款式

適用光源：LED AR111 42W / 32W / 22W / 12W

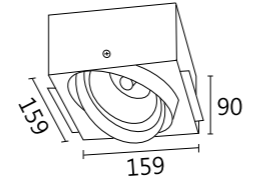

單位：mm

#### ◆ 材質參數 MATERIAL DESCRIPTION

|      |      |
|------|------|
| 材質   | 金屬   |
| 表面處理 | 表面烤漆 |
| 外框顏色 | 白色   |
| 內框顏色 | 黑色   |

#### ◆ 規格參數 SPECIFICATION

| 參數   | FIXTURE PROFILE |
|------|-----------------|
| 尺寸   | L159xW159xH90mm |
| 光源數  | LED AR111 *1    |
| 燈具嵌孔 | 160x160mm       |

#### ◆ 光源配備 OPTIONAL LAMP

| COB光源模組       | LED COB MODULE |
|---------------|----------------|
|               |                |
|               |                |
| AR111 COB 42W | AR111 COB 32W  |
| AR111 COB 22W | AR111 COB 12W  |

### SY-8017-3

- 應用各種間照設計
- 出光均勻
- 高演色性 CRI90 COB光源
- 無邊框款式

適用光源：LED AR111 42W / 32W / 22W / 12W

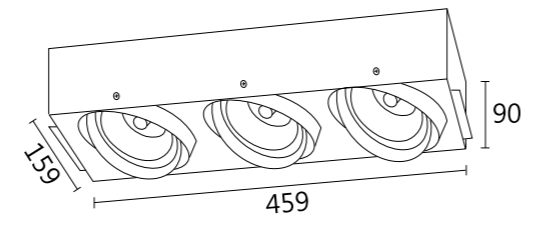

單位：mm

#### ◆ 材質參數 MATERIAL DESCRIPTION

|      |      |
|------|------|
| 材質   | 金屬   |
| 表面處理 | 表面烤漆 |
| 外框顏色 | 白色   |
| 內框顏色 | 黑色   |

#### ◆ 規格參數 SPECIFICATION

| 參數   | FIXTURE PROFILE |
|------|-----------------|
| 尺寸   | L459xW159xH90mm |
| 光源數  | LED AR111 *3    |
| 燈具嵌孔 | 160x460mm       |

#### ◆ 光源配備 OPTIONAL LAMP

| COB光源模組       | LED COB MODULE |
|---------------|----------------|
|               |                |
|               |                |
| AR111 COB 42W | AR111 COB 32W  |
| AR111 COB 22W | AR111 COB 12W  |

### SY-8017-2

- 應用各種間照設計
- 鐵框 鋼材沖壓一體成型
- 高演色性 CRI90 COB光源
- 無邊框款式

適用光源：LED AR111 42W / 32W / 22W / 12W

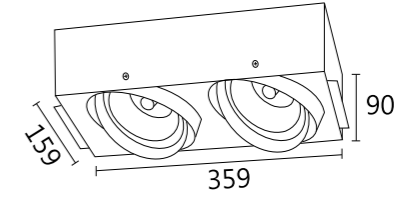

單位：mm

#### ◆ 材質參數 MATERIAL DESCRIPTION

|      |      |
|------|------|
| 材質   | 金屬   |
| 表面處理 | 表面烤漆 |
| 外框顏色 | 白色   |
| 內框顏色 | 黑色   |

#### ◆ 規格參數 SPECIFICATION

| 參數   | FIXTURE PROFILE |
|------|-----------------|
| 尺寸   | L359xW159xH90mm |
| 光源數  | LED AR111 *2    |
| 燈具嵌孔 | 160x310mm       |

#### ◆ 光源配備 OPTIONAL LAMP

| COB光源模組       | LED COB MODULE |
|---------------|----------------|
|               |                |
|               |                |
| AR111 COB 42W | AR111 COB 32W  |
| AR111 COB 22W | AR111 COB 12W  |





無光斑燈帶方案

# COB LED STRIP

Chip on FPCB, linear light, dot free  
Extremely flexible, high reliability



## COB 燈條 480CHIPS 5W 4mm PRO Version

- ▶ 發光角 180°
- ▶ 多種色溫選擇 2700K、3000K、4000K、6500K
- ▶ COB光源
- ▶ 4mm窄版燈條
- ▶ 高品質PCB；耐熱3M背膠條

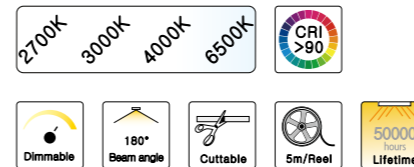

### 尺寸 DIMENSIONS

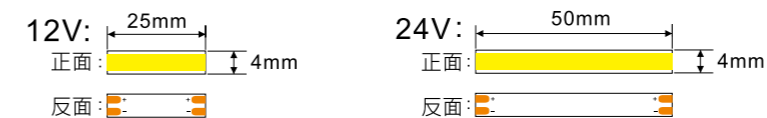
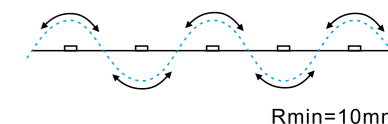
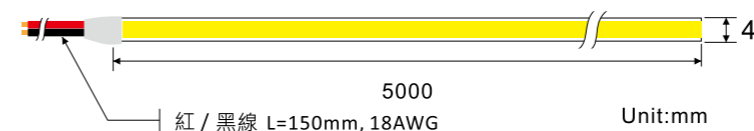

### 產品規格 SPECIFICATION

|                     |                       |
|---------------------|-----------------------|
| Dimension           | 5000mmx4mmx2mm        |
| Chip QTY.           | 480Chips/meter        |
| Step Chips          | 24pcs(24V)/12pcs(12V) |
| Step length         | 50mm(24V)/25mm(12V)   |
| Power(W/m)          | 5W                    |
| Voltage(V)          | DC24V/DC12V           |
| Current(A/m)        | 0.21A(24V)/0.42A(12V) |
| Copper foil         | 2oz                   |
| Ambient temperature | -20°C~+50°C           |

### 配光曲線

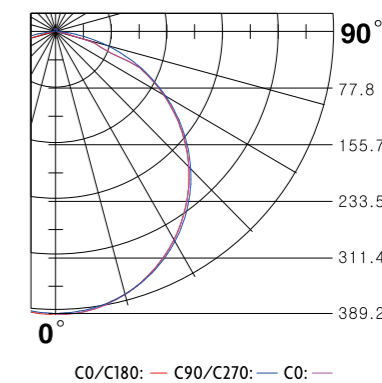

### 光學參數 (IP20 24V 測試數據)

| CCT (K)    | Lumen (lm/m) | Efficacy (lm/w) | CRI   | R9    | Rf (Fidelity) | Rg (Gamut) | EEL Class       |
|------------|--------------|-----------------|-------|-------|---------------|------------|-----------------|
| ▶ 2700±100 | 481.05       | 96.21           | 92.33 | 62.26 | 90.55         | 99.88      | A <sup>+</sup>  |
| ▶ 3000±100 | 512.80       | 102.56          | 93.25 | 64.51 | 92.36         | 100.39     | A <sup>+</sup>  |
| ▶ 4000±200 | 550.75       | 110.15          | 92.93 | 65.28 | 94.55         | 101.19     | A <sup>++</sup> |
| ▶ 6500±300 | 573.90       | 114.78          | 94.62 | 66.88 | 93.98         | 101.28     | A <sup>++</sup> |

# COB 燈條 480CHIPS 5W/10W/15W 8mm/10mm PRO Version

- ▶ 發光角 180°
- ▶ 多種色溫選擇 2700K、3000K、4000K、6500K
- ▶ COB光源
- ▶ 4mm窄版燈條
- ▶ 高品質PCB；耐熱3M背膠條

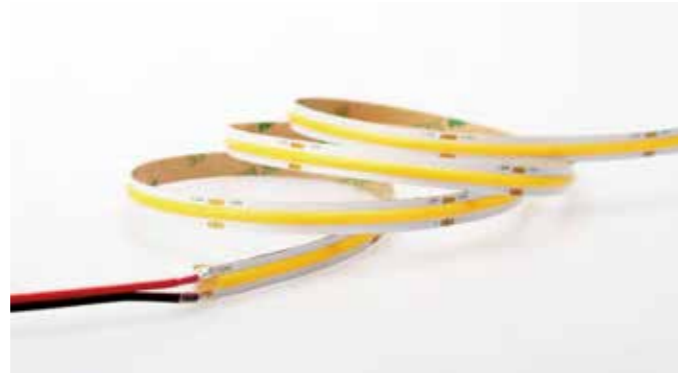
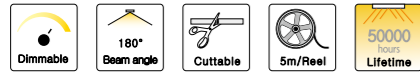
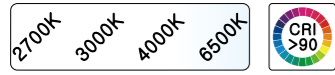

## 尺寸 DIMENSIONS

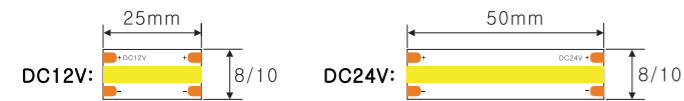
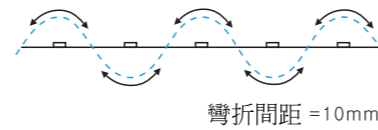
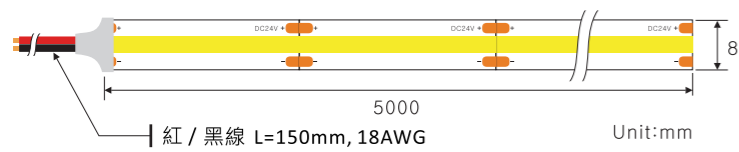

## 產品規格 SPECIFICATION

|                     |                                      |
|---------------------|--------------------------------------|
| Dimension           | 5000mmx8(10)mmx2mm                   |
| Chip QTY.           | 480Chips/meter                       |
| Step Chips          | 24pcs(24V)/12pcs(12V)                |
| Step length         | 50mm(24V)/25mm(12V)                  |
| Power(W/m)          | 5W/10W/15W                           |
| Voltage(V)          | DC24V/DC12V                          |
| Current(A/m)        | 0.21A,0.42A/0.42A,0.84A/0.625A,1.25A |
| Copper foil         | 2oz                                  |
| Ambient temperature | -20°C~+50°C                          |

## 配光曲線

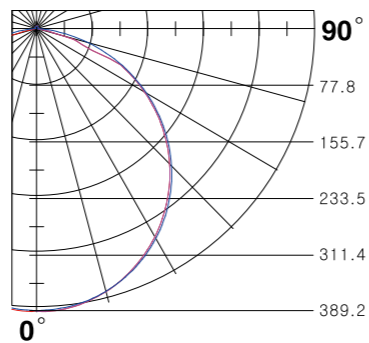

C0/C180: — C90/C270: — C0: —

## 光學參數 (IP20 24V 10mm 測試數據)

| CCT(Color)<br>(K) | Low power(5w/m) |                    | Low power(10w/m) |                    | Low power(15w/m) |                    | EEI Class<br>5w   10w   15w |
|-------------------|-----------------|--------------------|------------------|--------------------|------------------|--------------------|-----------------------------|
|                   | Lumen<br>(lm/m) | Efficacy<br>(lm/w) | Lumen<br>(lm/m)  | Efficacy<br>(lm/w) | Lumen<br>(lm/m)  | Efficacy<br>(lm/w) |                             |
| ▶ 2700±100        | 481.9           | 96.38              | 957.3            | 95.73              | 1418             | 94.53              | A*   A*   A*                |
| ▶ 3000±100        | 519.1           | 103.82             | 1029.0           | 102.90             | 1527             | 101.80             | A**   A*   A*               |
| ▶ 4000±200        | 575.0           | 115.00             | 1138.0           | 113.80             | 1690             | 112.67             | A**   A*   A*               |
| ▶ 6500±300        | 560.7           | 112.14             | 1124.0           | 112.40             | 1672             | 111.46             | A**   A*   A*               |

# COB 燈條 608CHIPS 20W 10mm TW Version

- ▶ 24V, flexible LED strip (16chips = 26.31mm) with 3M adhesive
- ▶ tape on the back for easy installed. 2009.8lm/m at 20W/m. 180° beam angle.
- ▶ Very good color reproduction with CRI>90. "One Bin Only" guarantees constant color temperature and high light quality at a lifetime of 54,000 hours (L70).
- ▶ Double-layer FPC(2Oz) for good heat dissipation.

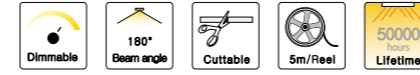
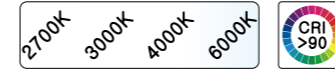

## 尺寸 DIMENSIONS

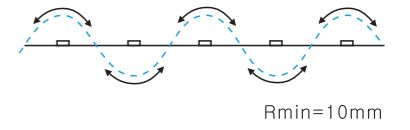
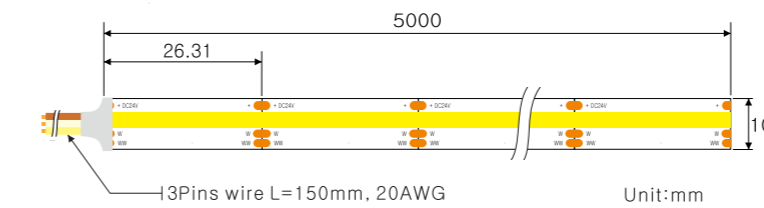

## 產品規格 SPECIFICATION

|              |                 |                       |            |
|--------------|-----------------|-----------------------|------------|
| Dimension    | 5000mmx10mmx2mm | Voltage(V)            | DC24V      |
| Chip Type    | COB             | Power(W/m)            | 20W        |
| Chip Density | 608pcb          | Current(A/m)          | 0.83A      |
| Step LEDs    | 16LEDs          | Beam Angle            | 180°       |
| Step length  | 26.31mm         | Operation Temperature | -20°C~50°C |

## 光學參數 (IP20 24V 測試數據)

| CCT<br>(K)          | Lumen<br>(lm/m) | POWER<br>W/M | Efficacy<br>(lm/w) | CRI<br>(>90) | R9    | TM-30-15         |               |
|---------------------|-----------------|--------------|--------------------|--------------|-------|------------------|---------------|
|                     |                 |              |                    |              |       | Rf<br>(Fidelity) | Rg<br>(Gamut) |
| ▶ 2700<br>only      | 958             | 10           | 95.80              | 90.19        | 76.83 | 92.95            | 101.86        |
| ▶ 6000<br>only      | 1075.8          | 10           | 107.58             | 93.55        | 95.85 | 91.94            | 102.94        |
| ▶ 2700+6000<br>both | 2009.8          | 20           | 110.49             | 95.51        | 98.83 | 92.96            | 104.91        |

# Tunable white series

This series is designed with dynamic color changes together with the possibility of modulating the CCT and brightness, offering important opportunities for designing and creating environments with a variety of styles in various spaces, such as home, casino and hotel.



## 可調色燈帶 2835SMD 120LEDs

- ▶ 2100K 至 6000K 可調色溫
- ▶ 可調光
- ▶ 高品質PCB；耐熱3M背膠條

2100K

2400K

2700K

3000K

4000K

6000K

CRI > 90

One Bin

Dimmable

120° Beam angle

Cutttable

5m/Reel

50000 Hour Lifetime

LM80 Compliant



### 尺寸 DIMENSIONS

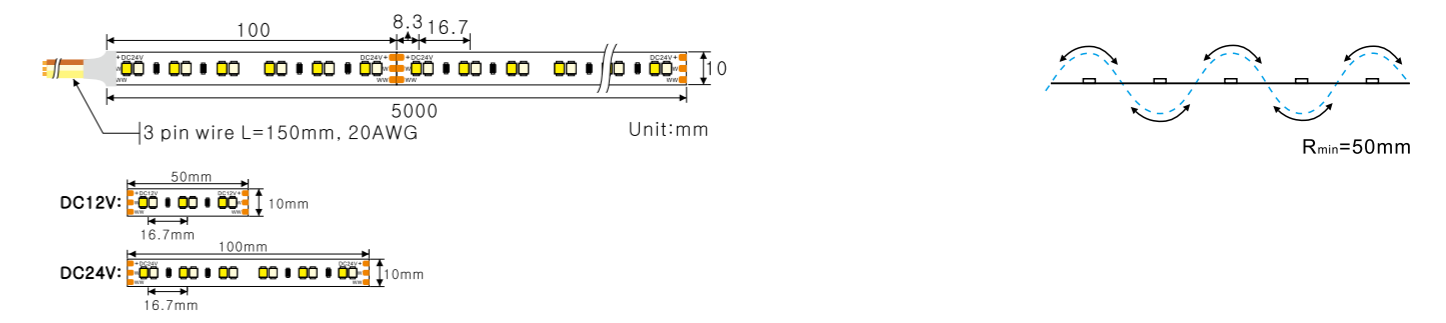

### 產品規格 SPECIFICATION

|                     |                         |
|---------------------|-------------------------|
| Dimension           | 5000mmx10mmx1.2mm       |
| Chip density        | 120LEDs/m, 16.7mm pitch |
| Step LEDs           | 12LEDs(24V)/6LEDs(12V)  |
| Step length         | 100mm(24V)/50mm(12V)    |
| Power(W)            | 24Watt/meter            |
| Voltage(V)          | DC24V/DC12V             |
| Current(A/m)        | 1A(24V)/2A(12V)         |
| Copper foil         | 2oz                     |
| Ambient temperature | -20°C~+50°C             |

### 配光曲線

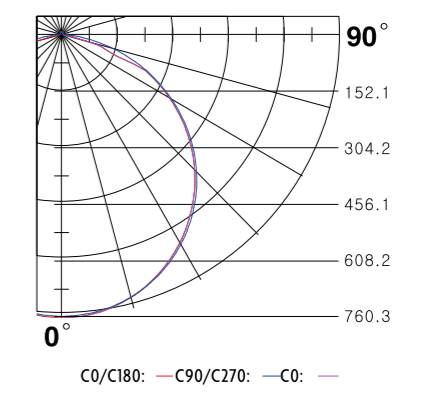

### 光學參數 (IP20 24V 測試數據)

| CCT (K)     | Lumen(lm/m)<br>CRI>90 CRI>80 | Efficacy(lm/w)<br>CRI>90 CRI>80 | CRI<br>CRI>90 CRI>80 | R9<br>CRI>90 CRI>80 | Rf(Fidelity)<br>CRI>90 CRI>80 | Rg(Gamut)<br>CRI>90 CRI>80 | EEL Class<br>CRI>90 CRI>80 |
|-------------|------------------------------|---------------------------------|----------------------|---------------------|-------------------------------|----------------------------|----------------------------|
| ▶ 2700± 100 | 978.14 1320.49               | 81.51 110.04                    | 92.00 83.72          | 83.33 10.21         | 90.21 84.15                   | 104.36 100.99              | B   B                      |
| ▶ 6000± 300 | 1204.12 1429.76              | 100.34 119.15                   | 94.97 83.29          | 84.60 8.35          | 92.21 90.49                   | 104.74 99.19               | B   A                      |
| ▶ 2700+6000 | 2160.58 2753.01              | 90.02 114.71                    | 97.29 85.07          | 78.15 8.15          | 93.58 81.23                   | 104.10 98.76               | A*   A*                    |



超長距恆流方案

# Constant current series

This PCB design is to satisfy the project's demand for longer length with only one end power feed, the current through each LED is constant to keep the same brightness from the beginning to the end for the strips, one power supply can drive such led strips in continuous length available for 10m/15m/20m/30m/40m/50m.

It is widely used in high-end spaces and projects, such as exhibition halls, brand stores, special hotels, museums, galleries, households, schools and hospitals.

## 50m SLCC 2835SMD 78LEDs

- ▶ 2835 高亮燈珠 · 單端供電達50公尺
- ▶ 多種色溫選擇 2700K、3000K、4000K、6000K
- ▶ 白光、紅、黃、藍、綠色等 特殊光色可選擇
- ▶ 高品質PCB；耐熱3M背膠條

2100K
2400K
2700K
3000K
4000K
6000K

R
G
B
Y
CRI >90

One Bin
Dimmable
120° Beam angle
Cuttable
5m/Reel
50000 hours Lifetime
LM80 Compliant

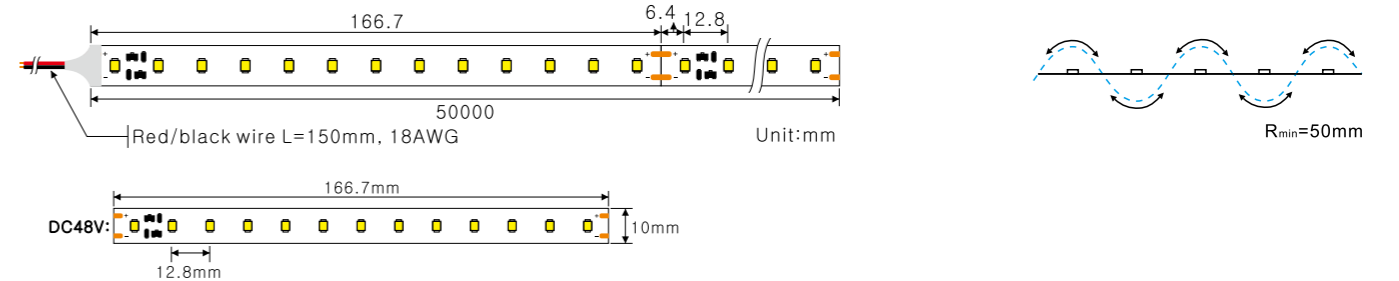

### 產品規格 SPECIFICATION

|                     |                        |
|---------------------|------------------------|
| Dimension           | 50000mmx10mmx2mm       |
| Chip density        | 78LEDs/m, 12.8mm pitch |
| Step LEDs           | 13LEDs                 |
| Step length         | 166.7mm                |
| Power(W)            | 4.5Watt/meter          |
| Voltage(V)          | DC48V                  |
| Current(A/m)        | 0.09A                  |
| Copper foil         | 3oz                    |
| Ambient temperature | -20°C~+50°C            |

### 配光曲線

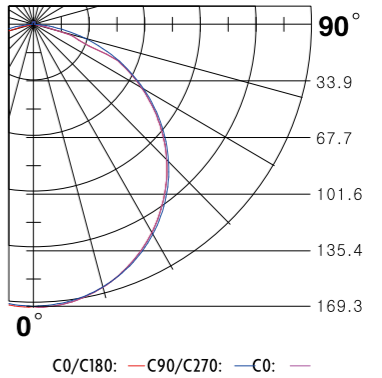

### 光學參數 (IP20 24V 測試數據)

| CCT (K)     | Lumen(lm/m)<br>CRI>90 CRI>80 | Efficacy(lm/w)<br>CRI>90 CRI>80 | CRI<br>CRI>90 CRI>80 | R9<br>CRI>90 CRI>80 | Rf(Fidelity)<br>CRI>90 CRI>80 | Rg(Gamut)<br>CRI>90 CRI>80 | EEI Class<br>CRI>90 CRI>80 |
|-------------|------------------------------|---------------------------------|----------------------|---------------------|-------------------------------|----------------------------|----------------------------|
| ▶ 2100± 100 | 336.07   470.04              | 80.02   111.91                  | 91.68   81.61        | 69.19   7.15        | 86.17   81.12                 | 101.15   90.16             | A+   A**                   |
| ▶ 2400± 100 | 370.05   504.05              | 88.11   120.01                  | 90.12   81.05        | 76.11   5.18        | 90.02   83.06                 | 101.20   92.02             | A+   A**                   |
| ▶ 2700± 100 | 392.01   529.13              | 93.34   125.98                  | 91.12   82.02        | 78.04   8.19        | 89.18   82.11                 | 100.13   96.06             | A+   A**                   |
| ▶ 3000± 100 | 403.08   554.08              | 95.97   131.92                  | 91.18   82.22        | 79.07   6.19        | 90.15   81.06                 | 102.08   92.20             | A+   A**                   |
| ▶ 4000± 200 | 457.69   569.16              | 108.97   135.51                 | 94.01   82.66        | 77.18   5.18        | 90.11   78.06                 | 99.06   95.13              | A**   A**                  |
| ▶ 6000± 300 | 481.10   573.10              | 114.55   136.45                 | 92.17   82.02        | 82.20   6.19        | 91.18   86.06                 | 101.05   96.03             | A**   A**                  |

# 30m SLCC 2835SMD 90LEDs

- ▶ 2835 高亮燈珠 · 單端供電達30公尺
- ▶ 多種色溫選擇 2700K、3000K、4000K、6000K
- ▶ 白光、紅、黃、藍、綠色等 特殊光色可選擇
- ▶ 高品質PCB；耐熱3M背膠條

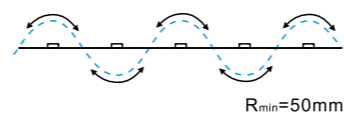
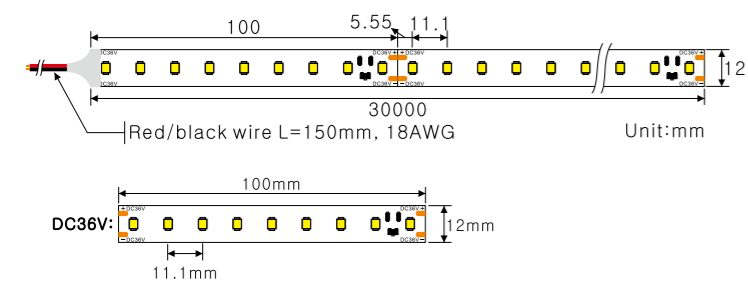
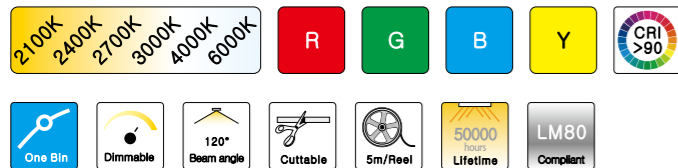

## 產品規格 SPECIFICATION

|                     |                        |
|---------------------|------------------------|
| Dimension           | 30000mmx12mmx2mm       |
| Chip density        | 90LEDs/m, 11.1mm pitch |
| Step LEDs           | 9LEDs                  |
| Step length         | 100mm                  |
| Power(W)            | 7.2Watt/meter          |
| Voltage(V)          | DC36V                  |
| Current(A/m)        | 0.2A                   |
| Copper foil         | 3oz                    |
| Ambient temperature | -20°C~+50°C            |

## 配光曲線

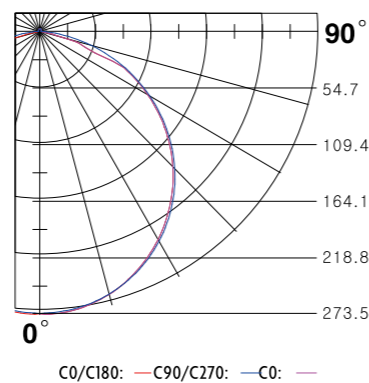

## 光學參數 (IP20 24V 測試數據)

| CCT (K)     | Lumen(lm/m)     | Efficacy(lm/w)  | CRI             | R9              | Rf(Fidelity)    | Rg(Gamut)       | EEL Class       |
|-------------|-----------------|-----------------|-----------------|-----------------|-----------------|-----------------|-----------------|
| (K)         | CRI>90   CRI>80 | CRI>90   CRI>80 | CRI>90   CRI>80 | CRI>90   CRI>80 | CRI>90   CRI>80 | CRI>90   CRI>80 | CRI>90   CRI>80 |
| ▶ 2100± 100 | 544.02   756.19 | 75.56   105.03  | 91.64   81.62   | 69.17   7.11    | 86.06   81.02   | 101.19   90.06  | A*   A*         |
| ▶ 2400± 100 | 597.15   816.17 | 82.94   113.36  | 90.17   81.07   | 76.07   5.20    | 90.07   83.15   | 101.08   92.15  | A*   A*         |
| ▶ 2700± 100 | 614.15   853.04 | 85.30   118.48  | 91.04   82.15   | 78.15   8.05    | 89.05   82.19   | 100.14   96.17  | A*   A**        |
| ▶ 3000± 100 | 655.10   892.06 | 90.99   123.90  | 91.10   82.31   | 79.11   6.09    | 90.13   81.11   | 102.01   92.17  | A*   A**        |
| ▶ 4000± 200 | 738.03   914.16 | 102.50   126.97 | 94.18   82.51   | 77.03   5.17    | 90.10   78.12   | 99.09   95.14   | A*   A**        |
| ▶ 6000± 300 | 777.14   920.14 | 107.94   127.80 | 92.09   82.10   | 82.08   6.14    | 91.06   86.11   | 101.10   96.14  | A*   A**        |

# 20m SLCC 2835SMD 60LEDs

- ▶ 2835 高亮燈珠 · 單端供電達20公尺
- ▶ 多種色溫選擇 2700K、3000K、4000K、6000K
- ▶ 白光、紅、黃、藍、綠色等 特殊光色可選擇
- ▶ 高品質PCB；耐熱3M背膠條

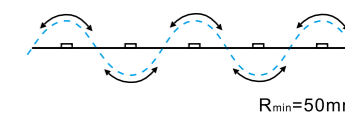
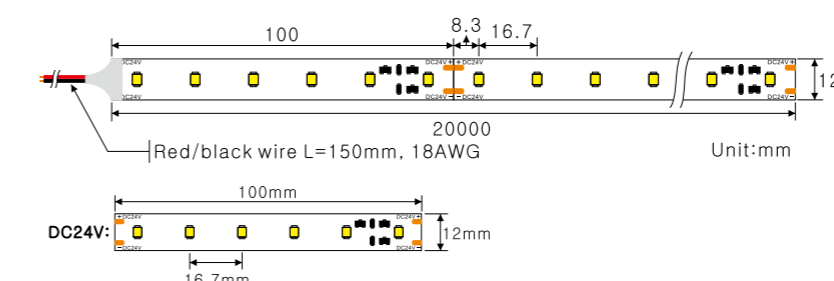
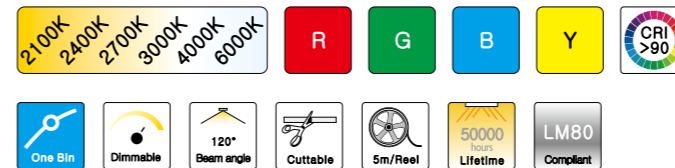

## 產品規格 SPECIFICATION

|                     |                        |
|---------------------|------------------------|
| Dimension           | 20000mmx12mmx2mm       |
| Chip density        | 60LEDs/m, 16.7mm pitch |
| Step LEDs           | 6LEDs                  |
| Step length         | 100mm                  |
| Power(W)            | 8.5Watt/meter          |
| Voltage(V)          | DC24V                  |
| Current(A/m)        | 0.35A                  |
| Copper foil         | 3oz                    |
| Ambient temperature | -20°C~+50°C            |

## 配光曲線

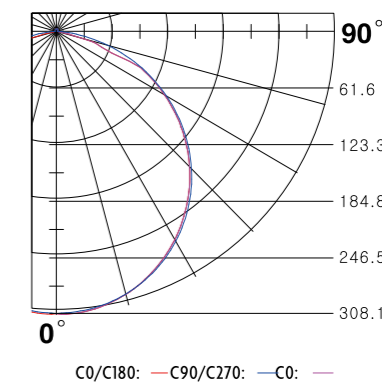

## 光學參數 (IP20 24V 測試數據)

| CCT (K)     | Lumen(lm/m)      | Efficacy(lm/w)  | CRI             | R9              | Rf(Fidelity)    | Rg(Gamut)       | EEL Class       |
|-------------|------------------|-----------------|-----------------|-----------------|-----------------|-----------------|-----------------|
| (K)         | CRI>90   CRI>80  | CRI>90   CRI>80 | CRI>90   CRI>80 | CRI>90   CRI>80 | CRI>90   CRI>80 | CRI>90   CRI>80 | CRI>90   CRI>80 |
| ▶ 2100± 100 | 615.80   859.60  | 72.45   101.13  | 91.70   82.60   | 70.40   10.60   | 87.10   83.40   | 101.40   91.80  | A*   A*         |
| ▶ 2400± 100 | 670.50   919.20  | 78.88   108.14  | 94.00   81.80   | 77.60   7.10    | 94.00   84.70   | 101.10   93.40  | A*   A*         |
| ▶ 2700± 100 | 715.00   960.70  | 84.12   113.02  | 94.30   83.30   | 79.60   10.80   | 92.00   85.30   | 102.00   100.00 | A*   A*         |
| ▶ 3000± 100 | 732.50   1002.40 | 86.18   117.93  | 94.00   85.00   | 81.00   8.80    | 93.30   84.10   | 102.30   92.10  | A*   A*         |
| ▶ 4000± 200 | 832.70   1030.70 | 97.96   121.26  | 95.90   84.70   | 77.80   7.90    | 92.10   80.00   | 100.60   98.80  | A*   A**        |
| ▶ 6000± 300 | 875.60   1042.30 | 103.01   122.62 | 95.90   82.30   | 84.70   7.30    | 94.20   88.70   | 102.80   97.90  | A*   A**        |

# Special series



## 暖色調光燈帶 (Dim to Warm)

- ▶ 在調光的過程中由 3000K 變化至 極暖色1900K
- ▶ 搭配 Triac, 0/1-10V, DALI, PWM CV驅動
- ▶ 高品質 PCB ; 耐熱3M背膠條

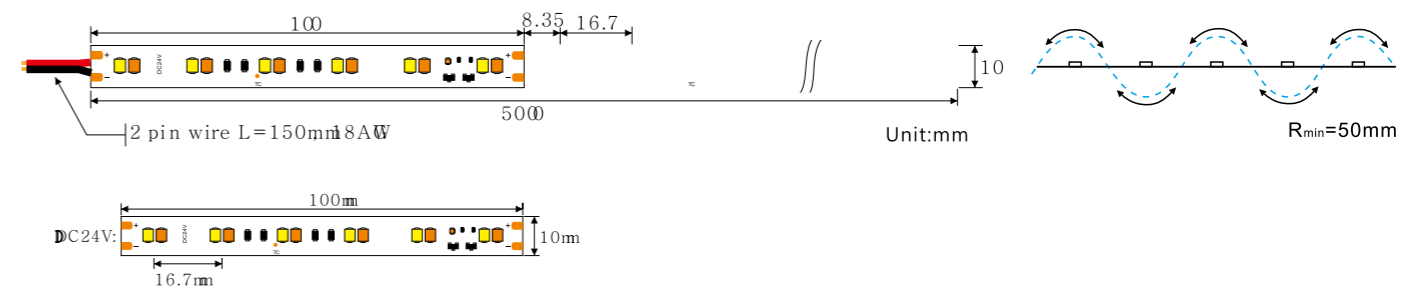

|                     |                         |
|---------------------|-------------------------|
| Dimension           | 5000mmx10mmx1.2mm       |
| Chip density        | 120LEDs/m, 16.7mm pitch |
| Step LEDs           | 12LEDs                  |
| Step length         | 100mm                   |
| Power(W)            | 14.4Watt/meter          |
|                     | 1137lumen/meter         |
| Voltage(V)          | DC24V                   |
| Current A/m)        | 0.6A                    |
| Copper foil         | 2oz                     |
| Ambient temperature | -20°C~+50°C             |

調光曲線 (Base on Ip20 CRI > 90)

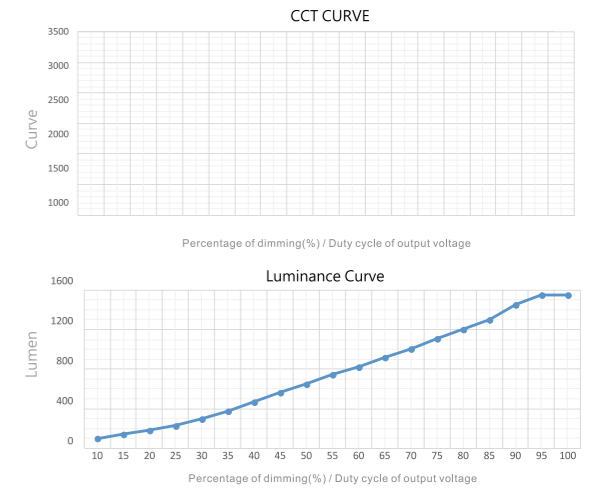

### Wiring Diagram

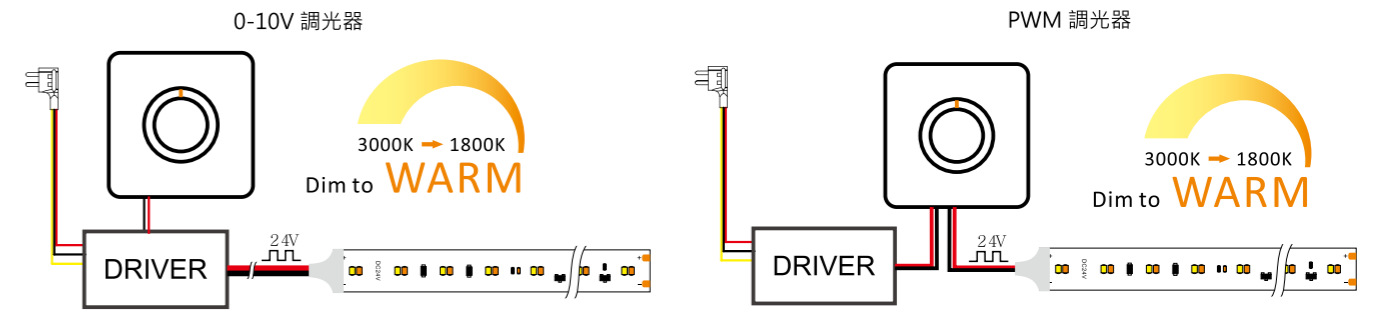

# 磁吸軌道燈

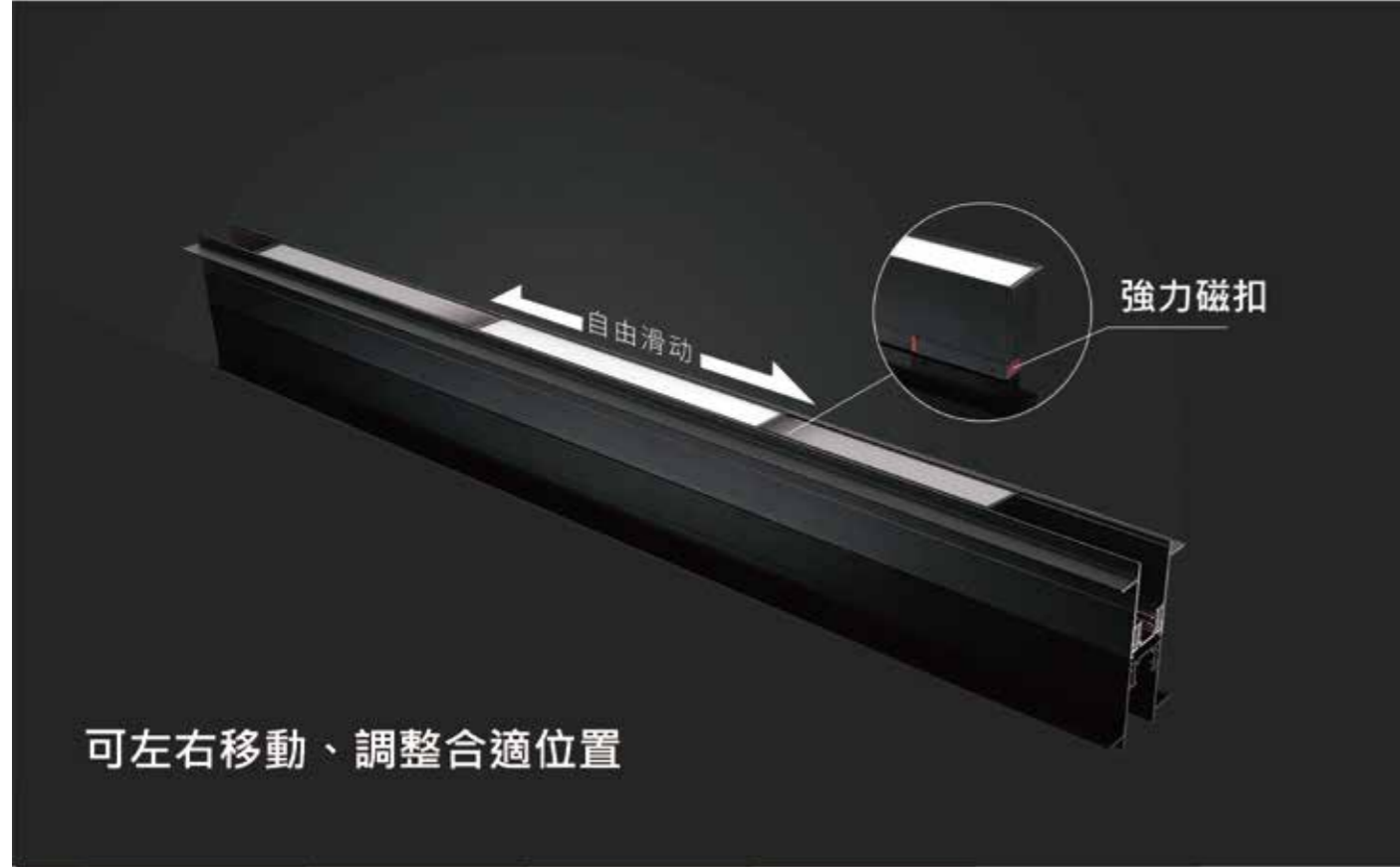

預埋型磁吸軌道條



吸頂型磁吸軌道條



磁吸軌道外接電源



磁吸專用內嵌式電源



外接電源專用接頭



軌道對接頭

### Line-300

#### 規格 Specification

尺寸：L300mm  
 功率：10W  
 色溫：3000K/4000K/6000K  
 顯指：>Ra90  
 發光角度：120D  
 電壓：DC48V



### Line-600

#### 規格 Specification

尺寸：L600mm  
 功率：20W  
 色溫：3000K/4000K/6000K  
 顯指：>Ra90  
 發光角度：泛光  
 光源品牌：OSRAM  
 電壓：DC48V



### Line-900

#### 規格 Specification

尺寸：L900mm  
 功率：30W  
 色溫：3000K/4000K/6000K  
 顯指：>Ra90  
 發光角度：泛光  
 光源品牌：OSRAM  
 電壓：DC48V



### Line-C2

#### 規格 Specification

規格 / 尺寸：L200mm  
 功率：20W  
 色溫：3000K/4000K/6000K  
 顯指：>Ra90  
 發光角度：泛光  
 光源品牌：CREE  
 電壓：DC48V

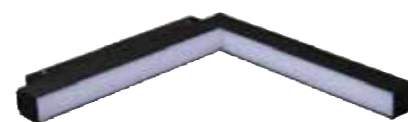

※ 牆面與天花板 L 形拐角連接

### Line-T

#### 規格 Specification

規格 / 尺寸：L380mm\*W191mm  
 功率：30W  
 色溫：3000K/4000K/6000K  
 顯指：>Ra90  
 發光角度：120°  
 光源品牌：CREE  
 電壓：DC48V



### Line-C1

#### 規格 Specification

規格 / 尺寸：L220mm  
 功率：20W  
 色溫：3000K/4000K/6000K  
 顯指：>Ra90  
 發光角度：泛光  
 光源品牌：CREE  
 電壓：DC48V

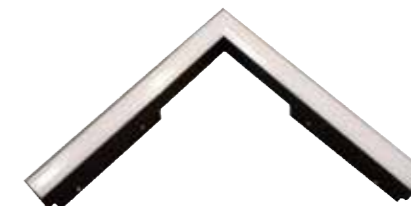

※ 牆面與牆面 L 形拐角連接

### Line-X

#### 規格 Specification

規格 / 尺寸：L405mm\*W380mm  
 功率：40W  
 色溫：3000K/4000K/6000K  
 顯指：>Ra90  
 發光角度：120°  
 光源品牌：CREE  
 電壓：DC48V





## MG-TK1

### 規格 Specification

功率：7W  
 色溫：3000K/4000K/6000K  
 演色性：Ra>90  
 發光角度：24°/(15°)(36°)  
 光源：CREE  
 輸入電壓：DC48V



## MG-TR6

### 規格 Specification

功率：6W  
 色溫：3000K/4000K/6000K  
 演色性：Ra>90  
 發光角度：24°  
 光源：CREE  
 輸入電壓：DC48V



## MG-TK2

### 規格 Specification

功率：10W  
 色溫：3000K/4000K/6000K  
 演色性：Ra>90  
 發光角度：24°/(15°)(36°)  
 光源：CREE  
 輸入電壓：DC48V



## MG-TR12

### 規格 Specification

功率：12W  
 色溫：3000K/4000K/6000K  
 演色性：Ra>90  
 發光角度：24°  
 光源：CREE  
 輸入電壓：DC48V



## MG-TK3

### 規格 Specification

功率：15W  
 色溫：3000K/4000K/6000K  
 演色性：Ra>90  
 發光角度：24°/(15°)(36°)  
 光源：CREE  
 輸入電壓：DC48V



## MG-PD10

### 規格 Specification

功率：10W  
 色溫：3000K/4000K/6000K  
 演色性：Ra>90  
 發光角度：24°  
 光源：CREE  
 輸入電壓：DC48V



## MG-TK4

### 規格 Specification

功率：15W  
 色溫：3000K/4000K/6000K  
 演色性：Ra>90  
 發光角度：24°/(15°)(36°)  
 光源：CREE  
 輸入電壓：DC48V



## MG-BT6

### 規格 Specification

尺寸：L165  
 功率：6W  
 色溫：3000K/4000K/6000K  
 演色性：Ra>80  
 光通量：600lm  
 光源：CREE  
 輸入電壓：DC48V

## MG-BT12

### 規格 Specification

尺寸：L320  
 功率：12W  
 色溫：3000K/4000K/6000K  
 演色性：Ra>80  
 光通量：1200lm  
 光源：CREE  
 輸入電壓：DC48V

## MG-BT18

### 規格 Specification

尺寸：L485  
 功率：18W  
 色溫：3000K/4000K/6000K  
 演色性：Ra>80  
 光通量：1800lm  
 光源：CREE  
 輸入電壓：DC48V

## MG-BT20

### 規格 Specification

尺寸：L540  
 功率：20W  
 色溫：3000K/4000K/6000K  
 演色性：Ra>80  
 光通量：2000lm  
 光源：CREE  
 輸入電壓：DC48V



26mm系列

MG-TK11

功率 7W / 12W  
 色溫 3000K / 4000K / 5000K  
 演色性 RA >90  
 發光角度 30D(7W) / 38D(12W)  
 輸入電壓 DC 48V



MG-TK12

功率 3W  
 色溫 3000K / 4000K / 5000K  
 演色性 RA >90  
 發光角度 40D  
 輸入電壓 DC 48V



MG-TK13 / MG-TK14

功率 12W / 24W  
 色溫 3000K / 4000K / 5000K  
 演色性 RA >90  
 發光角度 30D  
 輸入電壓 DC 48V



MG-TK15 / MG-TK16 / MG-TK17

功率 12W / 24W / 36W  
 色溫 3000K / 4000K / 5000K  
 演色性 RA >90  
 發光角度 120D  
 輸入電壓 DC 48V

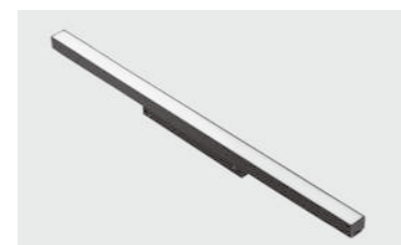

MG-TK18

功率 24W  
 色溫 3000K / 4000K / 5000K  
 演色性 RA >90  
 發光角度 120D  
 輸入電壓 DC 48V



MG-TK19

功率 12W  
 色溫 3000K / 4000K / 5000K  
 演色性 RA >90  
 發光角度 30D  
 輸入電壓 DC 48V



MG-TK21

功率 5W  
 色溫 3000K / 4000K  
 演色性 RA >90  
 發光角度 40D  
 輸入電壓 DC 48V



MG-TK23

功率 5W  
 色溫 3000K / 4000K  
 演色性 RA >90  
 發光角度 120D  
 輸入電壓 DC 48V

MG-TK20

功率 12W  
 色溫 3000K / 4000K / 5000K  
 演色性 RA >90  
 發光角度 120D  
 輸入電壓 DC 48V



MG-TK22

功率 5W  
 色溫 3000K / 4000K  
 演色性 RA >90  
 發光角度 40D  
 輸入電壓 DC 48V



# LED 光膜照明方案

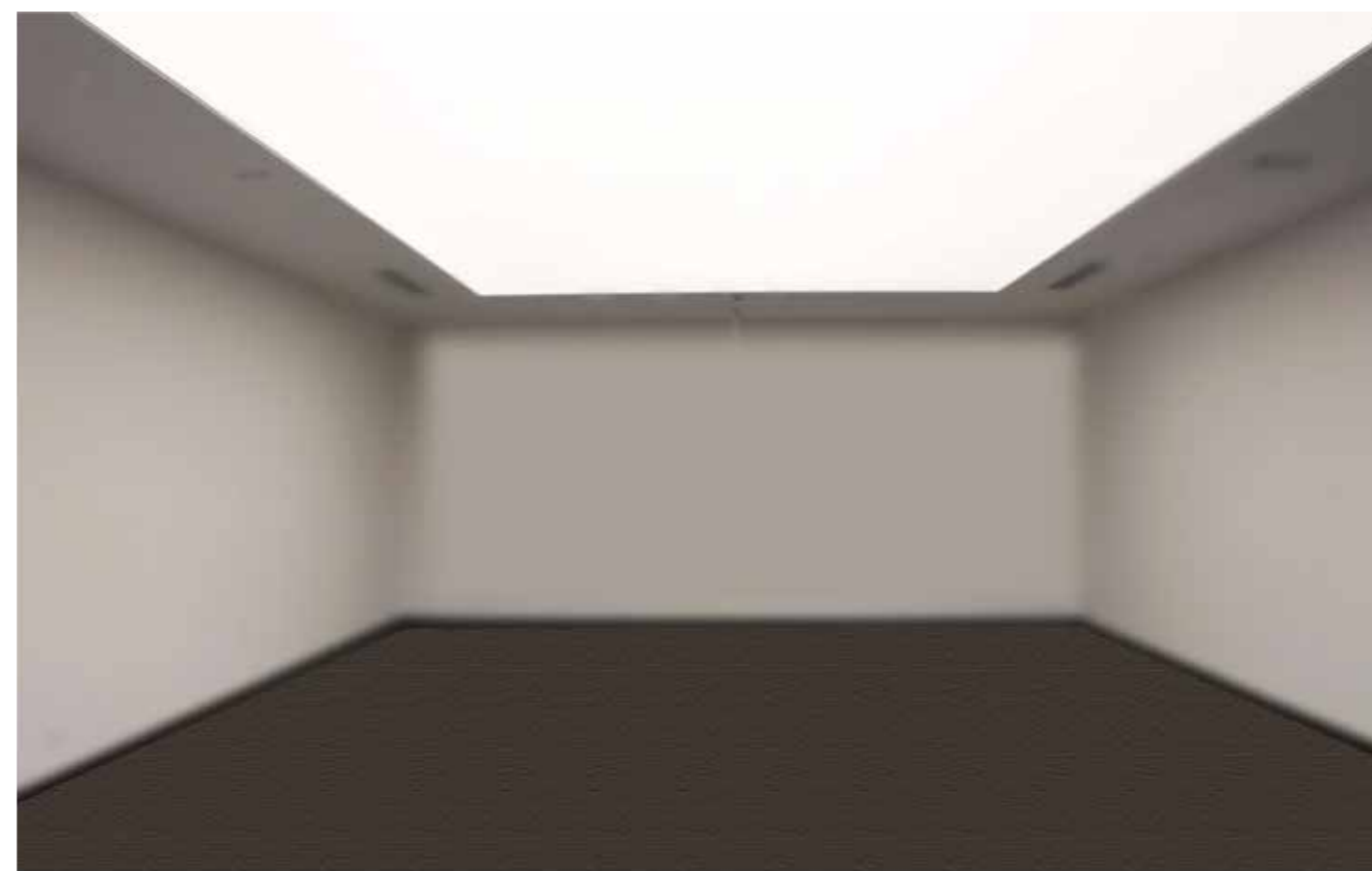

# 導光膜

(Light Guide Film, LGF)

其厚度僅 0.15mm 至 0.19mm，產品優勢超輕薄可彎曲，藉由表面微結構分佈，將入光的 LED 光束透過折射原理進而達到導光效果



## 節能功能

光面的表面可發現無數凹凸紋路，目的是將燈光折射度加強，此方法可大幅減少光源數量，材質為 PVC，能有效提高絕緣功能，更能大量減低室內溫度流失，尤其是經常需要開啟空調的環境。原理如同潛水員穿的潛水服延遲體溫流失一樣。

## 創造性

光膜是一種軟性材質，是根據邊骨的形狀來確定它的形狀，所以造型可隨意，多樣化，滿足設計師的各種設計理念。

## 抗老化

專用邊骨材質為鋁合金，主體材質為 PVC，這些組件壽命可達 10 年以上，正確安裝使用中不會產生裂紋。

## 光膜特性

- 01 **防火阻燃**  
在空氣中遇到明火，不易燃燒並與數秒內收縮後自動熄滅
- 02 **防水防污**  
採用封閉式設計，可防止灰塵濕氣
- 03 **防霉抗菌**  
出廠前經抗菌處理，能抵抗和防止微生物生長

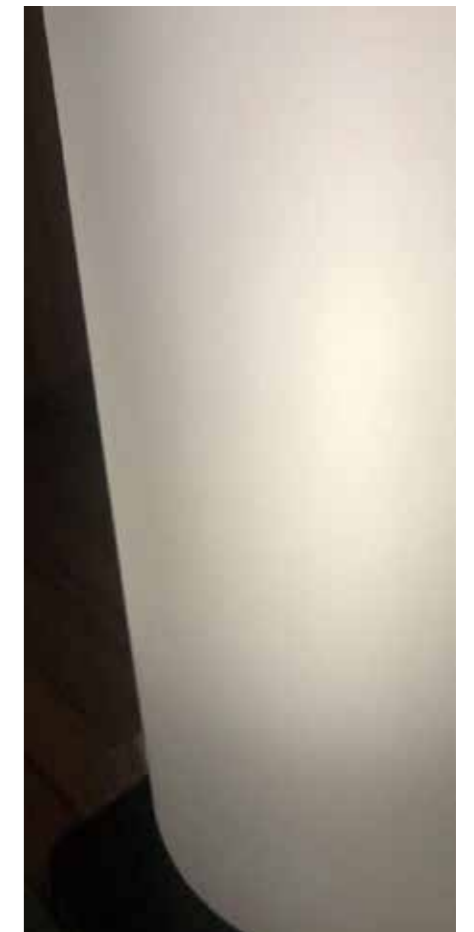

# F1006

- 配合現場施作吸頂、吊掛
- PVC軟光膜出光均勻
- 光學透鏡模組 · 無光斑

適用 2835 120燈/米 5.6w/ 3000K / 4000K / 6000K / 5mm / CRI>90  
 適用 2835 120燈/米 13w/ 3000K / 4000K / 6000K / 10mm / CRI>90

## ◆ 基本參數 BASIC PARAMETERS

|            |                   |
|------------|-------------------|
| 光源數量 / 平方米 | 100pcs            |
| 消耗功率 / 平方米 | 100W              |
| 光通量 / 平方米  | 7000lm            |
| 色溫         | 黃光、自然光、白光         |
| 光源種類       | LED               |
| 燈具尺寸(最大)   | 10m x 6m (配合現場木作) |
| 調光         | 可訂製               |
| 調色         | 可訂製               |



依據現場連接燈具  
 可透過多顆驅動連接  
 對接至配線所在位置

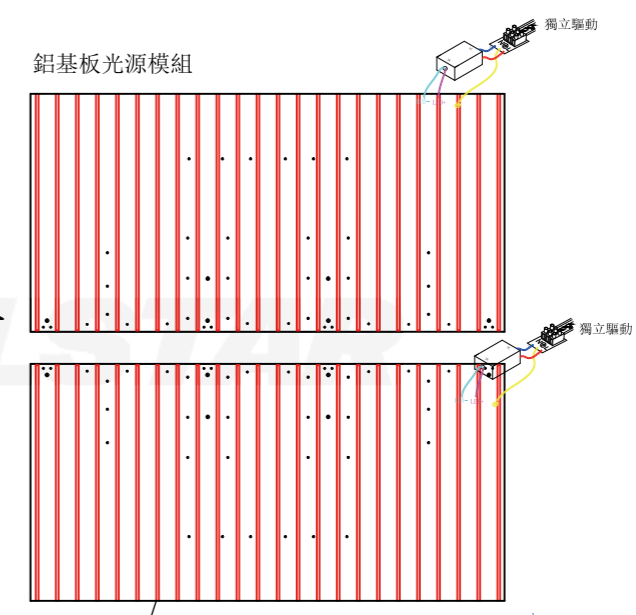
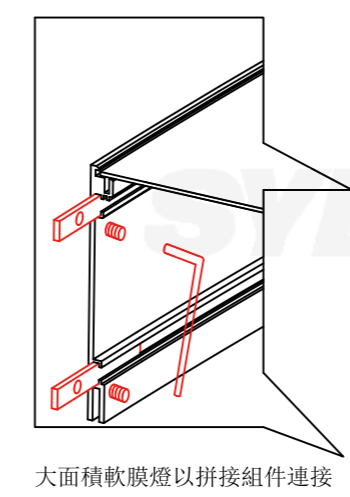

軟燈膜  
 PVC薄膜

採用光學透鏡  
 製造大面積發光效果

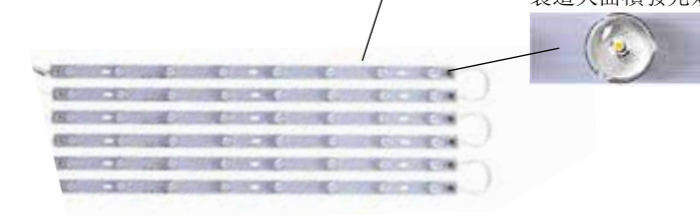

## 產品說明

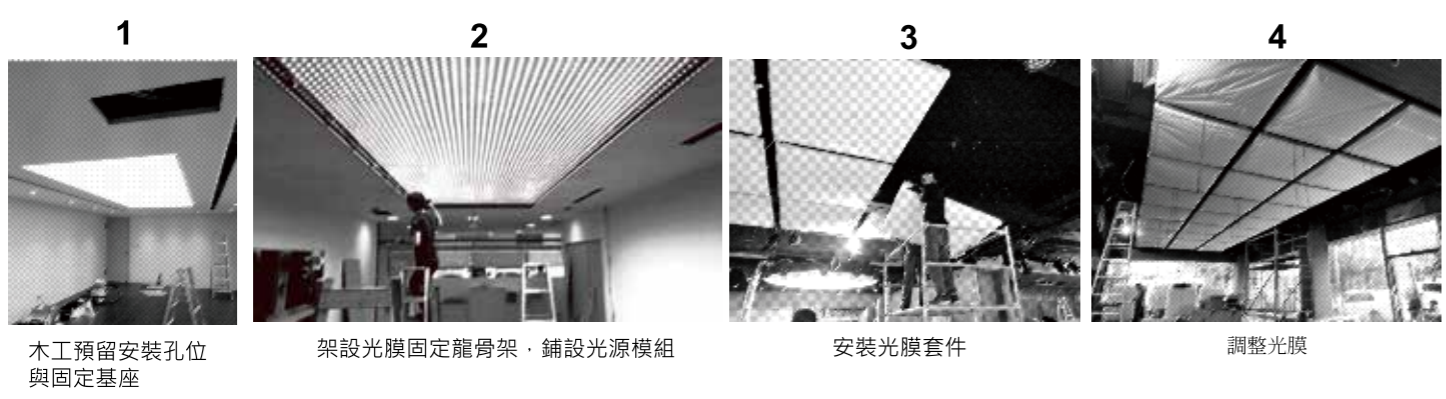

## 模擬示意圖



## 安裝需求



1. 光源至光膜 深度保留 8-10cm
2. 燈孔立面四邊木框厚度至少6分板 (16-18cm) 以利鎖附螺絲

單色溫需配置1對DC電源輸出線  
 雙色溫需配置2對DC電源輸出線  
 線徑建議 1.0mm 以上(17AWG)

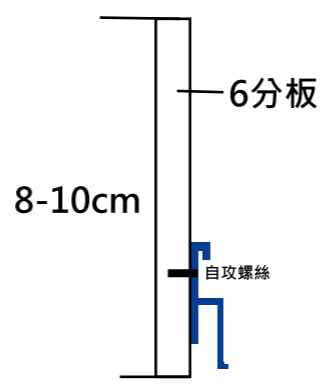



# 軌道式照明



| 功率  | 額定電壓       | 發光角度 | 色溫                      | 演色性     | 尺寸 (mm)    |
|-----|------------|------|-------------------------|---------|------------|
| 15W | 100-240Vac | 30度  | 3000K<br>4000K<br>6000K | RA > 90 | Ø90 x H110 |



## 7W

- 應用各種間照設計
- 鋁壓鑄散熱器
- 高演色性光源
- 適用二線式軌道

美國 Bridgelux COB 芯片  
CRI 90 高演色性晶片



## ◆ 材質參數 MATERIAL DESCRIPTION

|      |         |
|------|---------|
| 材質   | 壓鑄鋁     |
| 表面處理 | 表面烤漆    |
| 外觀顏色 | 白色 / 黑色 |



## ◆ 規格參數 SPECIFICATION

| 參數   | FIXTURE PROFILE       |
|------|-----------------------|
| 尺寸   | Ø50xH100mm            |
| 光源數  | LED COB               |
| 色溫   | 3000K / 4000K / 6000K |
| 輸入電壓 | AC 100-240V, 50/60Hz  |
| 演色性  | Ra 90 / 80            |

## 6W

- 應用各種間照設計
- 鋁壓鑄散熱器
- 高演色性光源
- 適用二線式軌道

美國 Bridgelux COB 芯片  
CRI 80 高演色性晶片



BSMI 安規MR16

## ◆ 材質參數 MATERIAL DESCRIPTION

|      |         |
|------|---------|
| 材質   | 壓鑄鋁     |
| 表面處理 | 表面烤漆    |
| 外觀顏色 | 白色 / 黑色 |



## ◆ 規格參數 SPECIFICATION

| 參數   | FIXTURE PROFILE       |
|------|-----------------------|
| 尺寸   | W90xH95mm             |
| 光源數  | LED MR16              |
| 色溫   | 3000K / 4000K / 6000K |
| 輸入電壓 | AC 100-240V, 50/60Hz  |
| 演色性  | Ra 80                 |

## 15W

- 應用各種間照設計
- 鋁壓鑄散熱器
- 高演色性光源
- 適用二線式軌道

美國 Bridgelux COB 芯片  
CRI 90 高演色性晶片



## ◆ 材質參數 MATERIAL DESCRIPTION

|      |         |
|------|---------|
| 材質   | 壓鑄鋁     |
| 表面處理 | 表面烤漆    |
| 外觀顏色 | 白色 / 黑色 |



## ◆ 規格參數 SPECIFICATION

| 參數   | FIXTURE PROFILE       |
|------|-----------------------|
| 尺寸   | Ø49xH128mm            |
| 光源數  | LED COB               |
| 色溫   | 3000K / 4000K / 6000K |
| 輸入電壓 | AC 100-240V, 50/60Hz  |
| 演色性  | Ra 90 / 80            |

## 25W (可調焦)

- 應用各種間照設計
- 鋁壓鑄散熱器
- 高演色性光源
- 適用二線式軌道

美國 Bridgelux COB 芯片  
CRI 90 高演色性晶片



## ◆ 材質參數 MATERIAL DESCRIPTION

|      |         |
|------|---------|
| 材質   | 壓鑄鋁     |
| 表面處理 | 表面烤漆    |
| 外觀顏色 | 白色 / 黑色 |



## ◆ 規格參數 SPECIFICATION

| 參數   | FIXTURE PROFILE       |
|------|-----------------------|
| 尺寸   | Ø80xH150mm            |
| 光源數  | LED COB               |
| 色溫   | 3000K / 4000K / 6000K |
| 輸入電壓 | AC 220V, 50/60Hz      |
| 演色性  | Ra 90                 |

## 25W / 35W

- 應用各種間照設計
- 鋁壓鑄散熱器
- 高演色性光源
- 適用二線式軌道

美國 Bridgelux COB 芯片  
CRI 90 高演色性晶片



## ◆ 材質參數 MATERIAL DESCRIPTION

|      |         |
|------|---------|
| 材質   | 壓鑄鋁     |
| 表面處理 | 表面烤漆    |
| 外觀顏色 | 白色 / 黑色 |



## ◆ 規格參數 SPECIFICATION

| 參數   | FIXTURE PROFILE                      |
|------|--------------------------------------|
| 尺寸   | Ø65xH155mm (25W)    Ø72xH182mm (35W) |
| 光源數  | LED COB                              |
| 色溫   | 3000K / 4000K / 6000K                |
| 輸入電壓 | AC 100-240V, 50/60Hz                 |
| 演色性  | Ra 90                                |

# 戶外照明

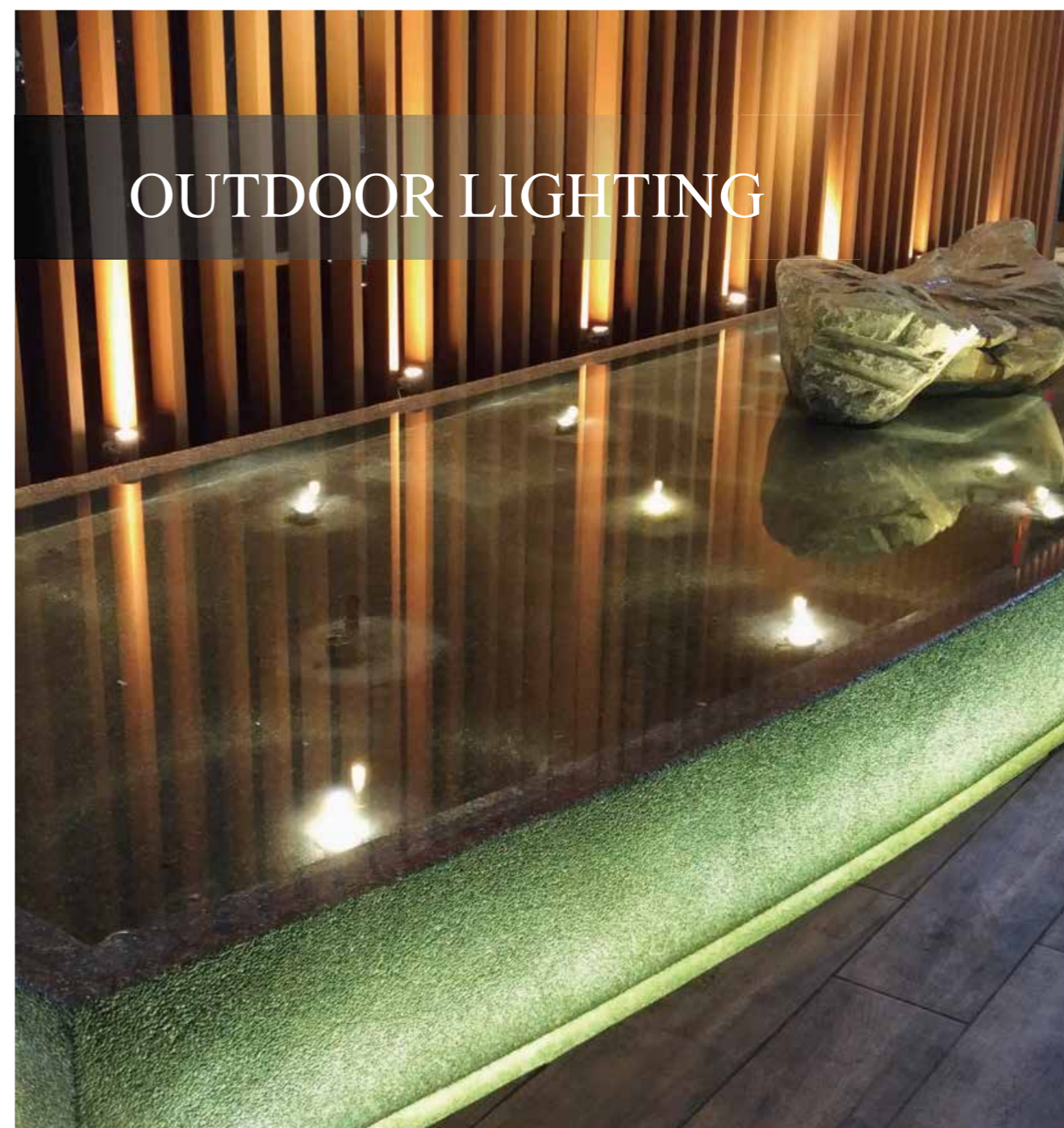



# LED 景觀照明

IP55



SL46102

- LED : CREE-COB 30W

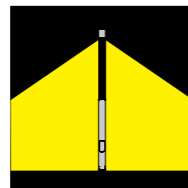

## 燈具規範

- 鋁合金壓鑄及鋁擠型燈具本體
- 燈罩為透明強化安全安全玻璃
- 矽膠防水墊圈
- 220C 高溫粉體烤漆



IP55

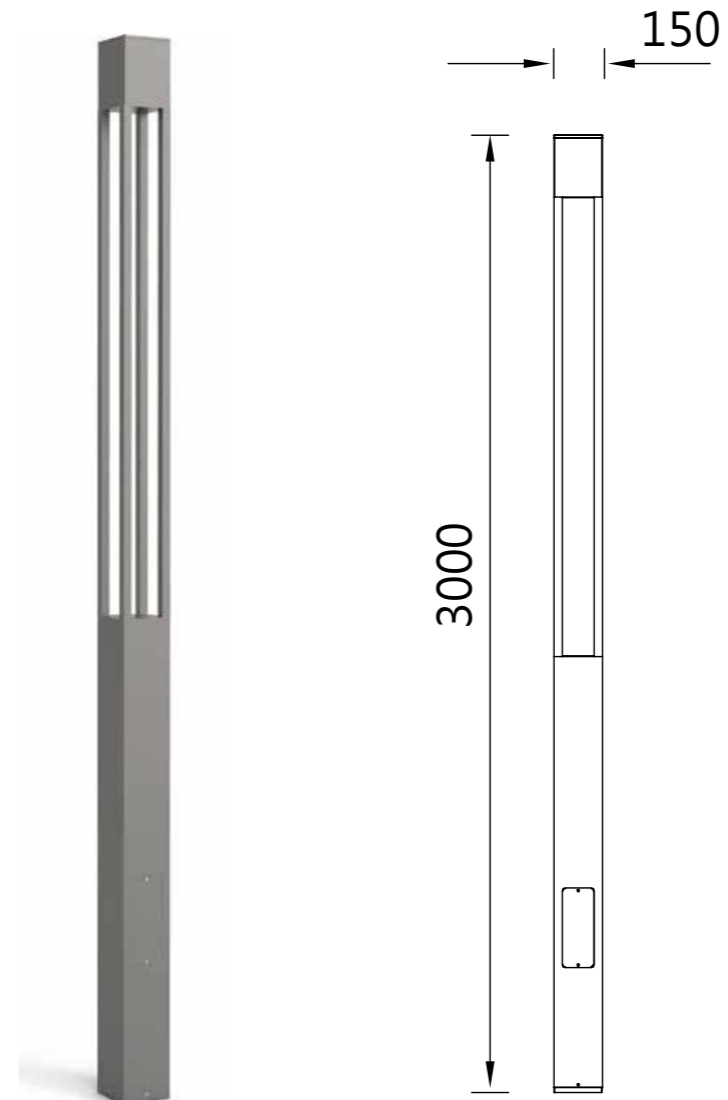

SL103104

- LED : CREE-COB 30W

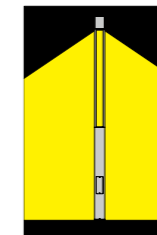

## 燈具規範

- 鋁合金壓鑄及鋁擠型燈具本體
- 燈罩為透明強化安全安全玻璃
- 矽膠防水墊圈
- 220C 高溫粉體烤漆



IP65

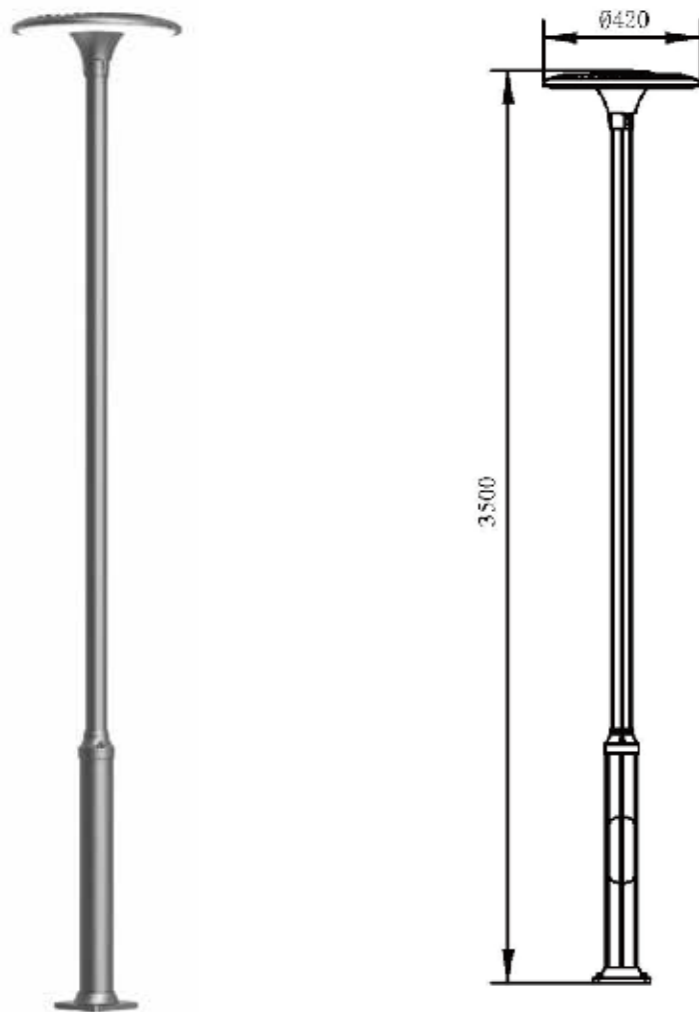

SL5023

- LED : OSRAM 60W



### 燈具規範

- 鋁合金壓鑄燈具本體
- 燈罩為乳白 PC 塑膠射出一體成型
- 鋁擠型條紋管兩節式燈桿
- 矽膠防水墊圈
- 220C 高溫粉體烤漆



IP55

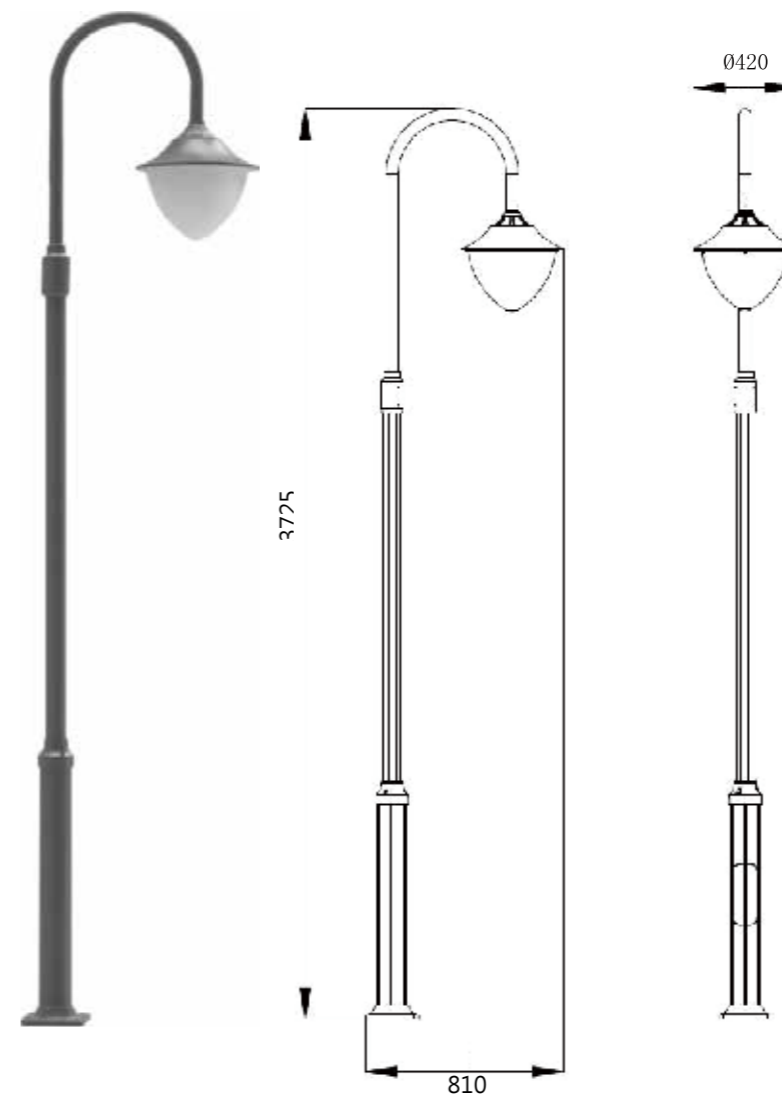

SL5021

- LED : OSRAM 36W

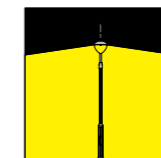

### 燈具規範

- 鋁合金壓鑄燈具本體
- 燈罩為霧面 PC 塑膠射出一體成型
- 鋁擠型條紋管兩節式燈桿
- 矽膠防水墊圈
- 220C 高溫粉體烤漆



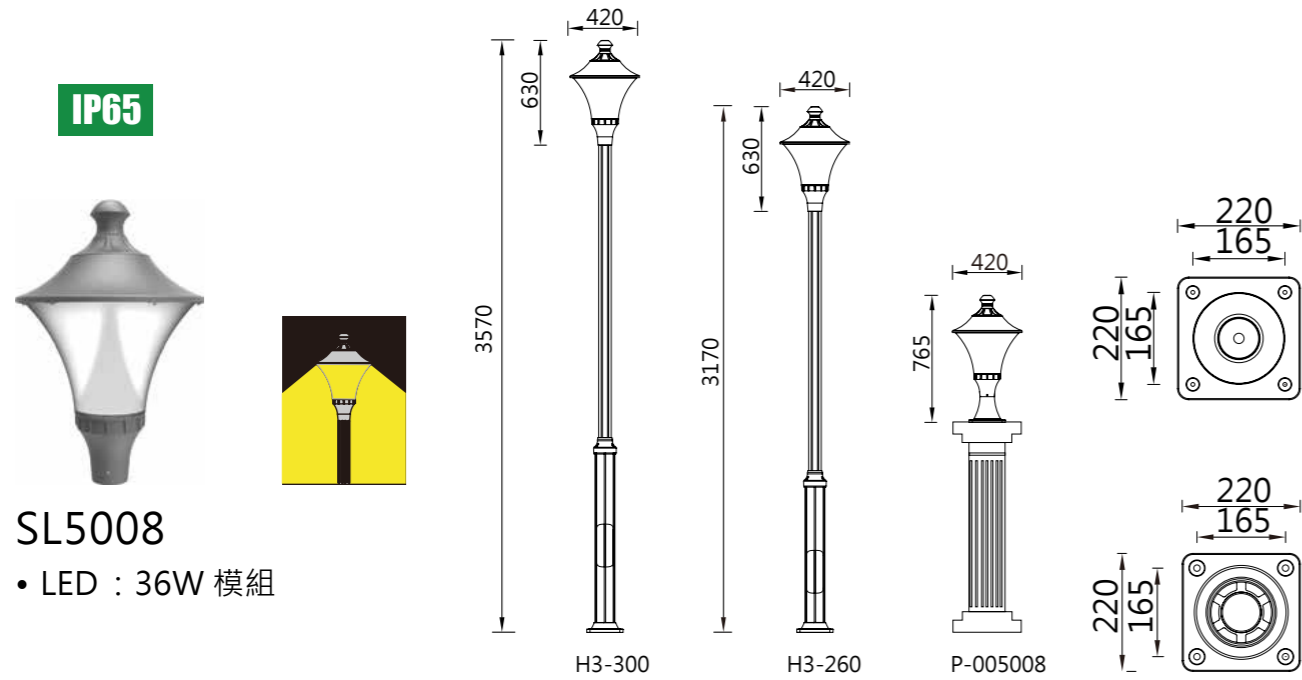

**SL5008**  
• LED : 36W 模組

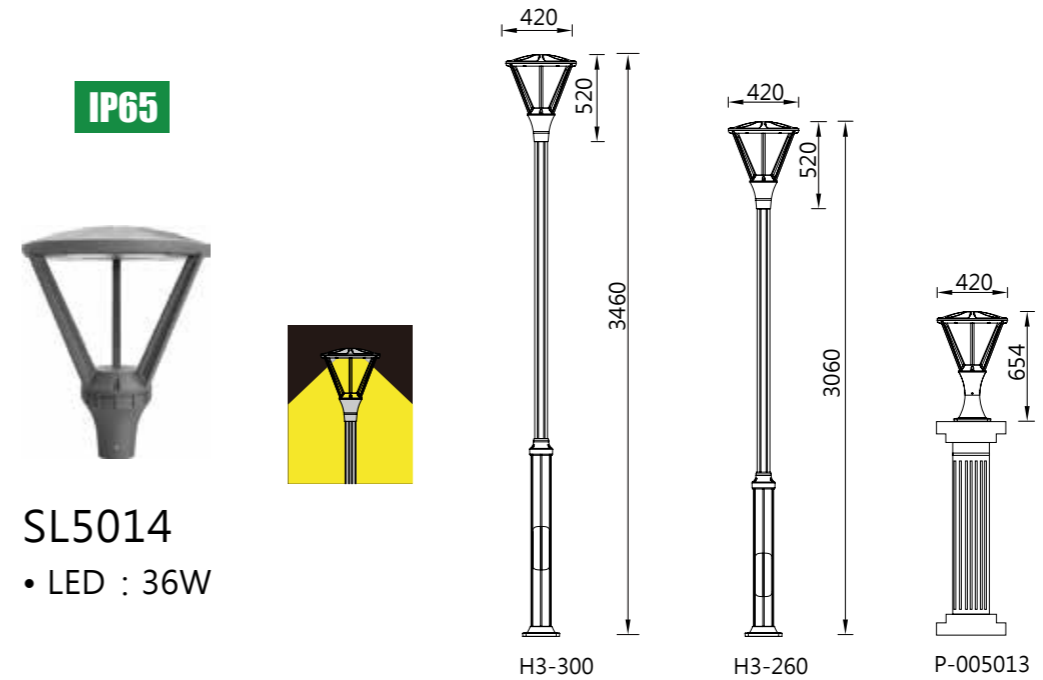

**SL5014**  
• LED : 36W

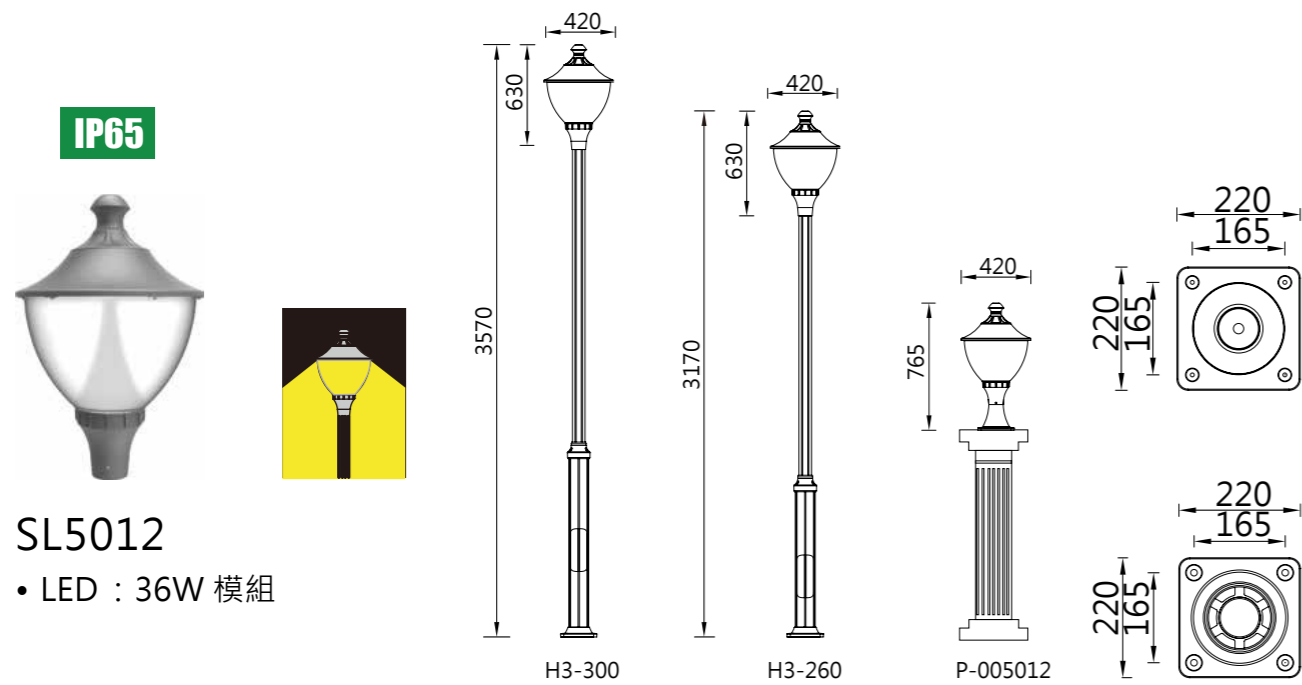

**SL5012**  
• LED : 36W 模組

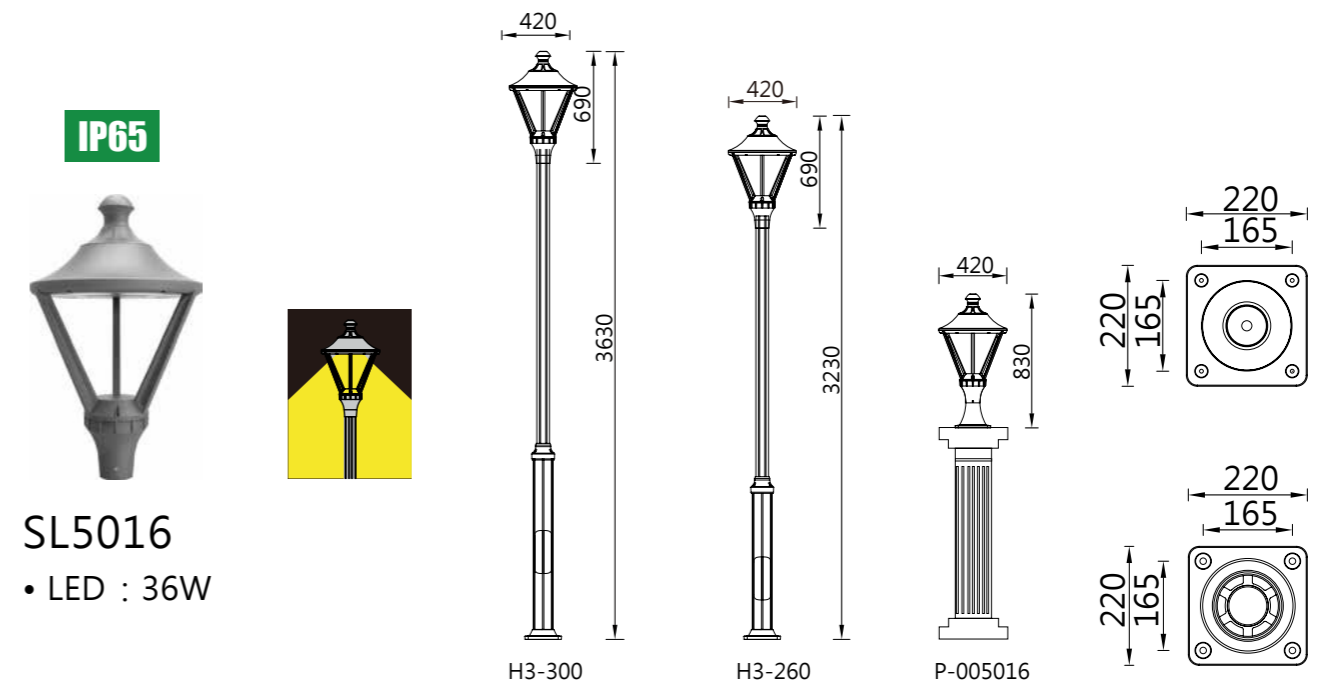

**SL5016**  
• LED : 36W

### 燈具規範

- 鋁合金壓鑄燈具本體
- 燈罩為霧面 PC 塑膠射出一體成型
- 白色圓錐形塑膠射出導光柱
- 矽膠防水墊圈
- 220C 高溫粉體烤漆

### 燈具規範

- 鋁合金壓鑄燈具本體
- 燈罩為霧面 PC 塑膠射出一體成型
- 白色圓錐形塑膠射出導光柱
- 矽膠防水墊圈
- 220C 高溫粉體烤漆

# LED 戶外壁燈

## SL 3076

- LED : OSRAM 12W

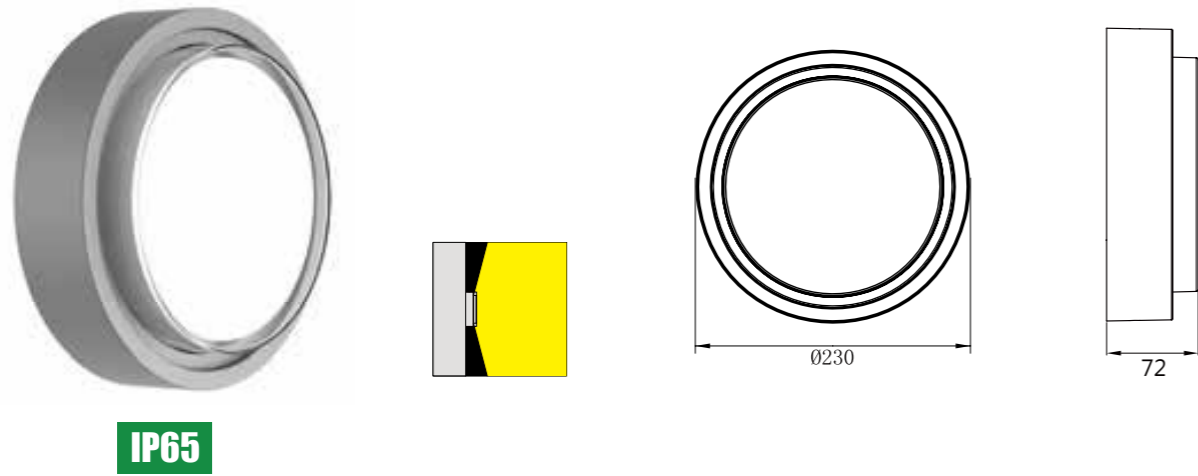

## SL 3081

- LED : OSRAM 12W

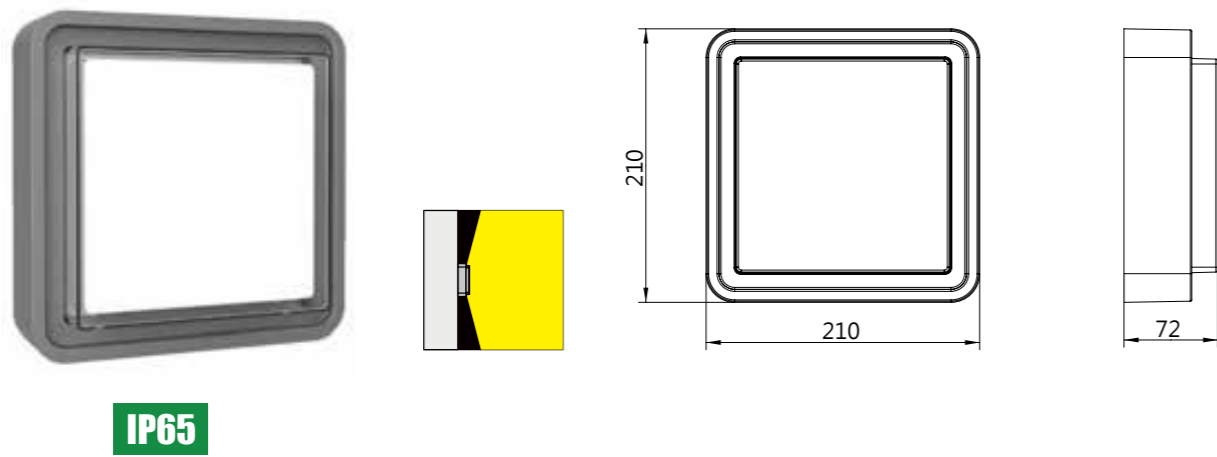

### 燈具規範

- 鋁合金壓鑄燈具本體
- 燈罩為乳白 PC 塑膠射出一體成型
- 矽膠防水墊圈
- 220C 高溫粉體烤漆

## SL 23381

- LED : OSRAM 8W

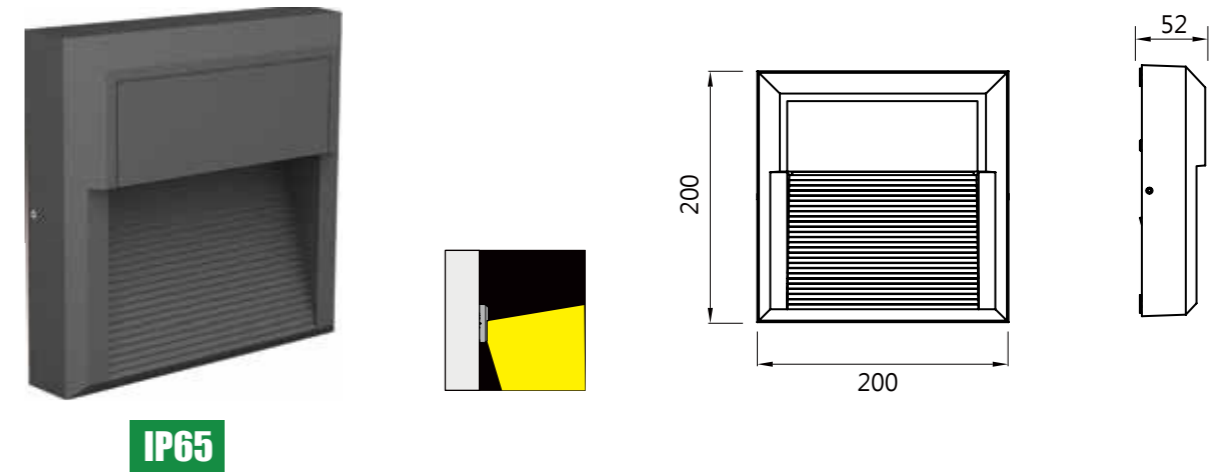

## SL 23382

- LED : OSRAM 8W

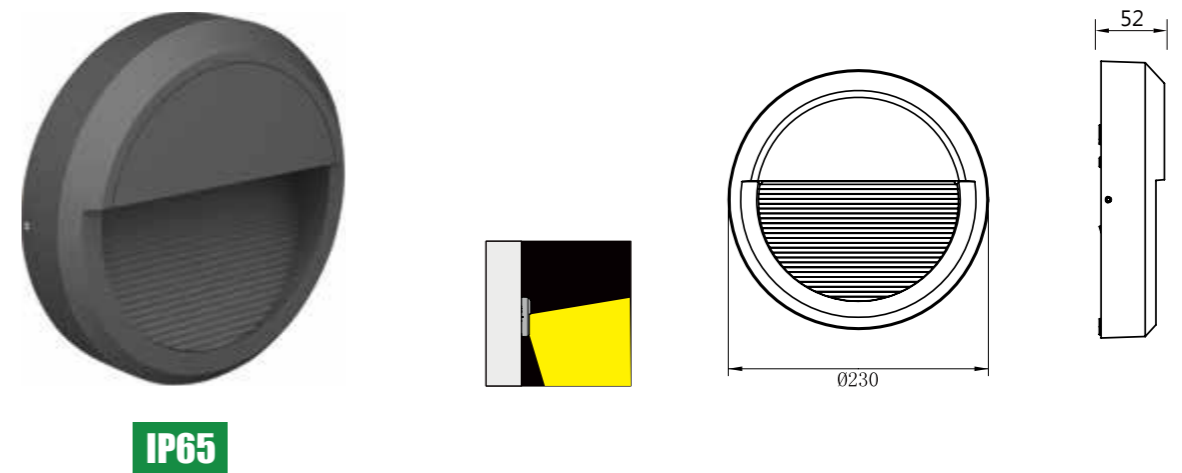

### 燈具規範

- 鋁合金壓鑄燈具本體
- 燈罩為乳白 PC 塑膠射出一體成型
- 矽膠防水墊圈
- 220C 高溫粉體烤漆



### SW3110

- LED : OSRAM 6W

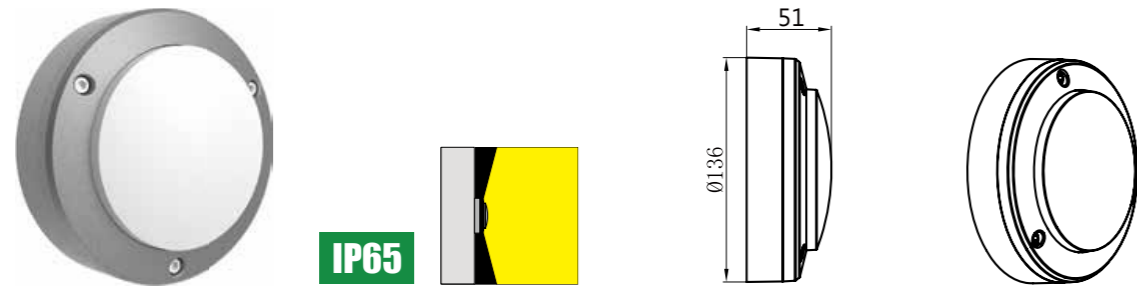

### SW3110M

- LED : OSRAM 16W

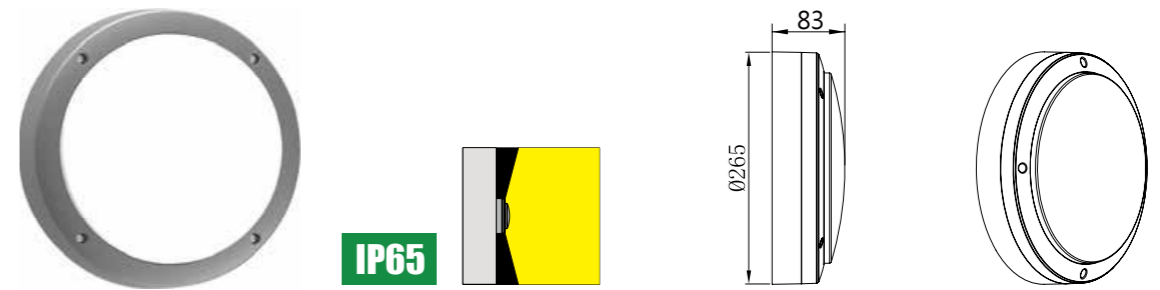

### SW13110

- LED : OSRAM 6W

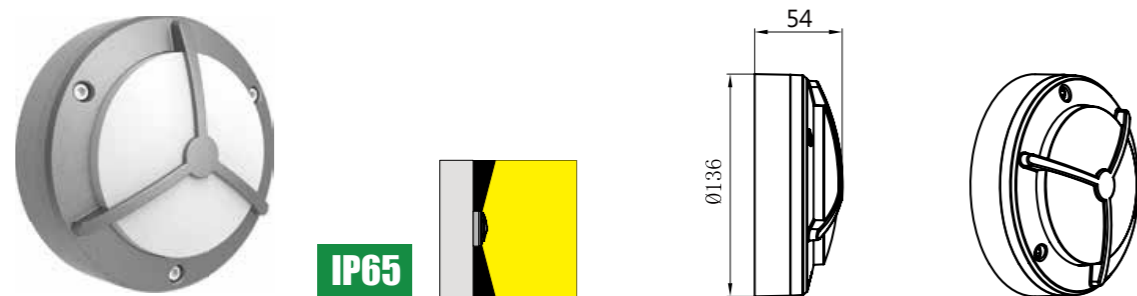

### SW13110M

- LED : OSRAM 16W

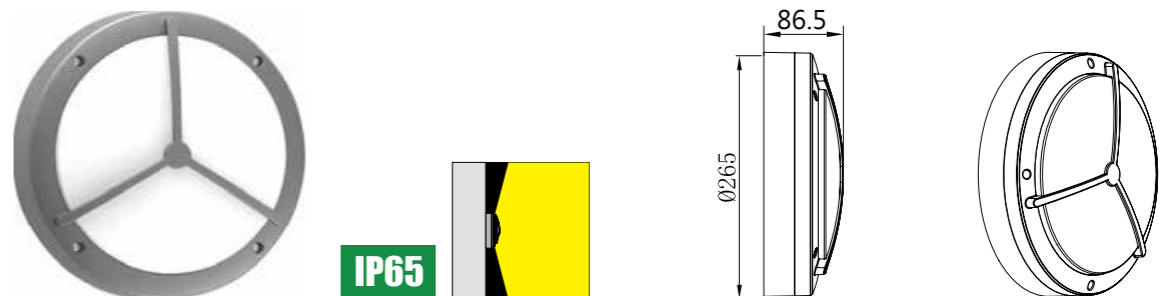

### SW23110

- LED : OSRAM 6W

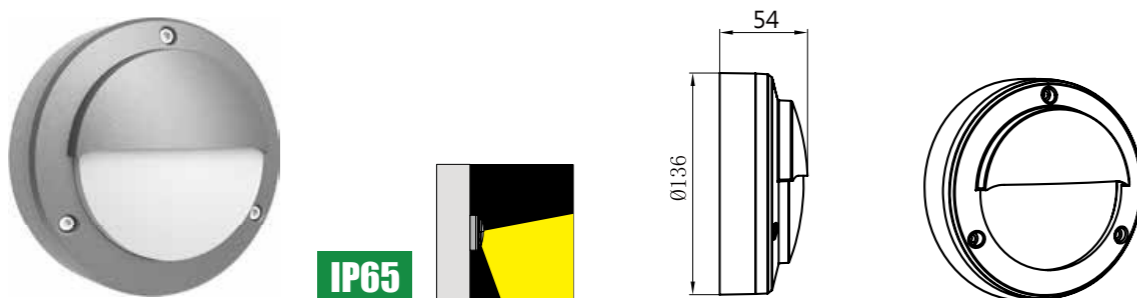

### SW23110M

- LED : OSRAM 16W

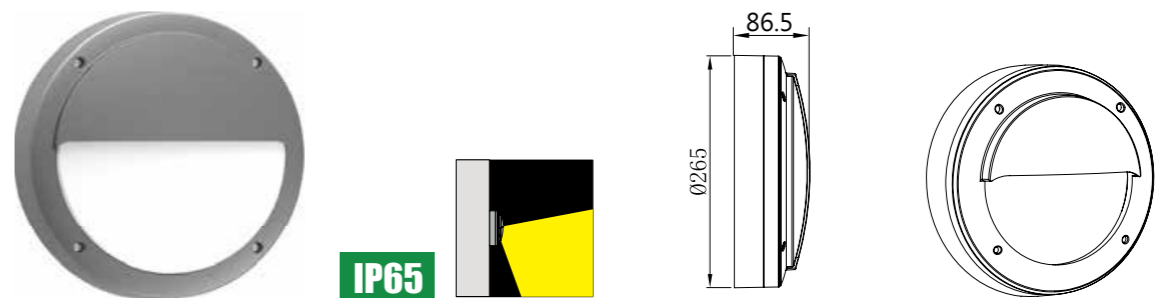

#### 燈具規範

- 鋁合金壓鑄燈具本體
- 燈罩為乳白 PC 塑膠射出一體成型

- 矽膠防水墊圈
- 220C 高溫粉體烤漆

#### 燈具規範

- 鋁合金壓鑄燈具本體
- 燈罩為乳白 PC 塑膠射出一體成型

- 矽膠防水墊圈
- 220C 高溫粉體烤漆

### SW5080

• E27



IP55

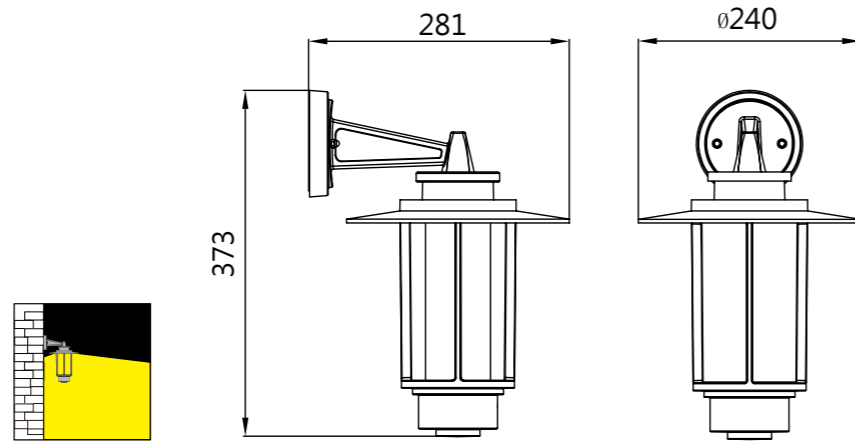

### SW5083

• LED : COB 8W



IP55

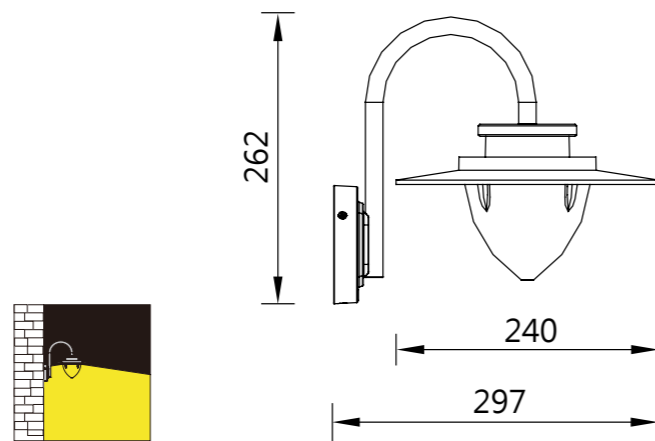

#### 燈具規範

- 鋁合金壓鑄燈具本體
- 燈罩為乳白 PC 塑膠射出一體成型
- 矽膠防水墊圈
- 220C 高溫粉體烤漆

### SW3037

• LED : COB 6Wx2



IP65

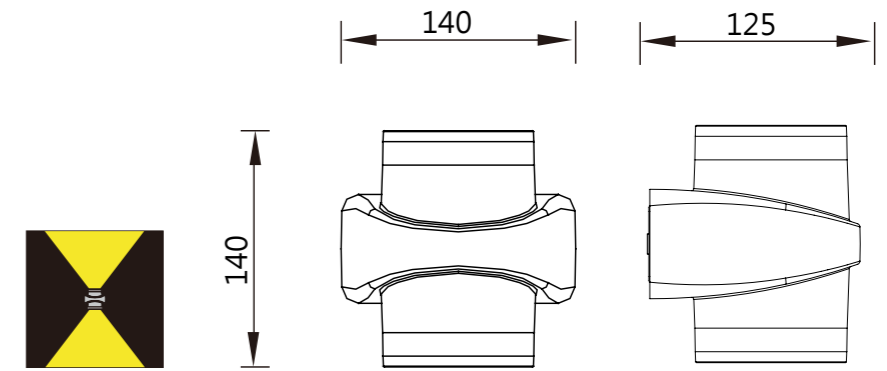

### SW3035

• LED : COB 8W



IP65

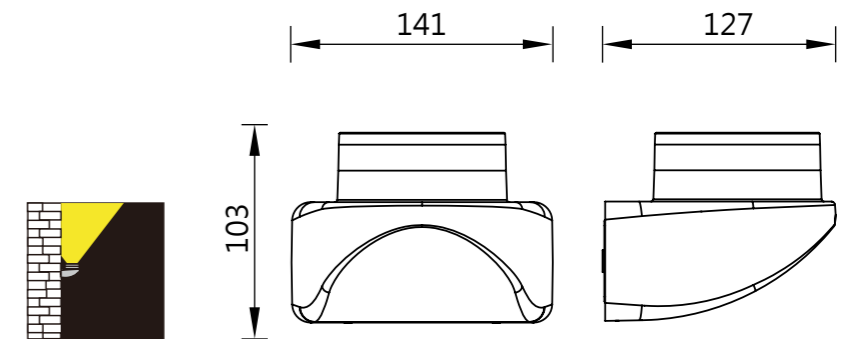

#### 燈具規範

- 鋁合金壓鑄燈具本體
- 燈罩為乳白 PC+ 透明強化安全玻璃
- 矽膠防水墊圈
- 220C 高溫粉體烤漆

### SW3327

- LED : 10W

### SW13327

- LED : 6Wx2



IP65



SW3327



SW13327

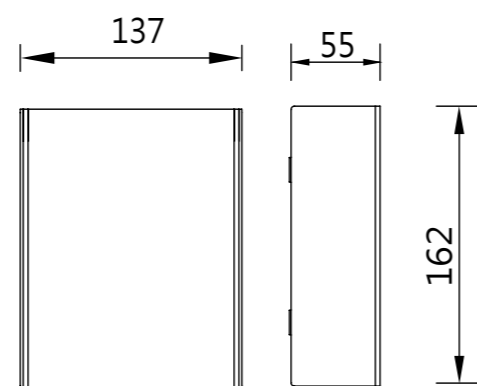

### SW3046

- LED : CREE-COB 6Wx2



IP65

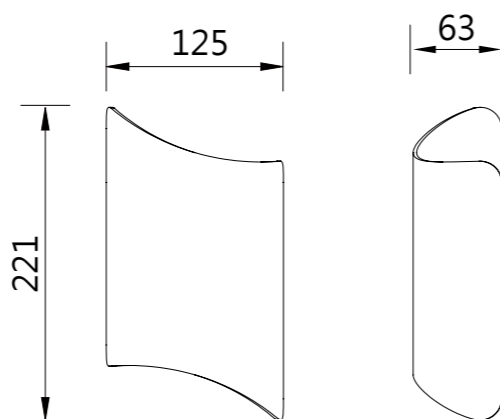
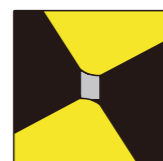

#### 燈具規範

- 鋁合金壓鑄燈具本體
- 燈罩為透明強化安全玻璃
- 矽膠防水墊圈
- 220C 高溫粉體烤漆

### SW3060

- LED : CREE-COB 3Wx2



IP65

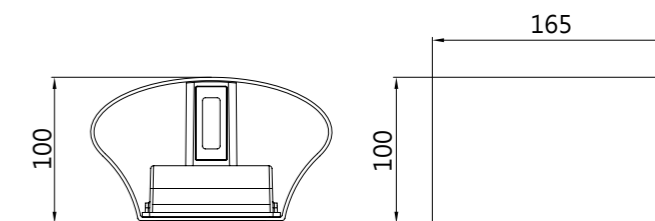

### SW3061

- LED : CREE-COB 3Wx2



IP65

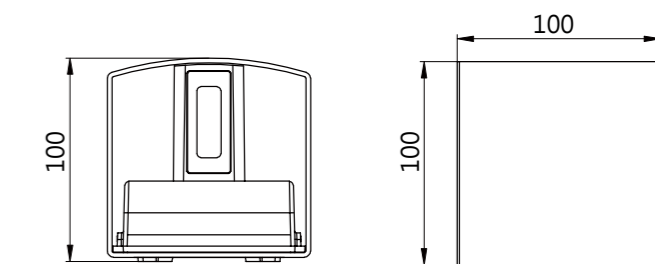

#### 燈具規範

- 鋁合金壓鑄燈具本體
- 燈罩為透明強化安全玻璃
- 矽膠防水墊圈
- 220C 高溫粉體烤漆

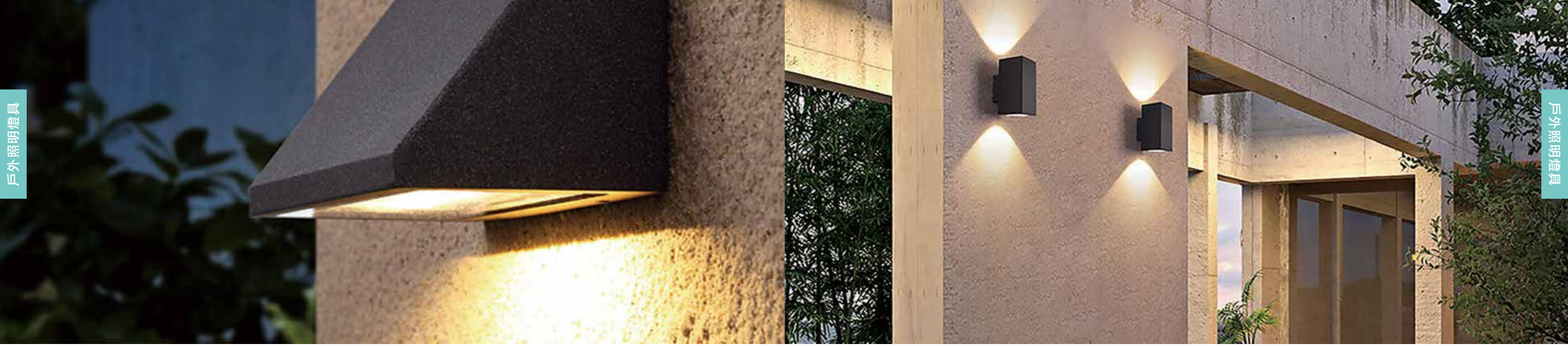

### SW3054

- LED : OSRAM 8W



IP65

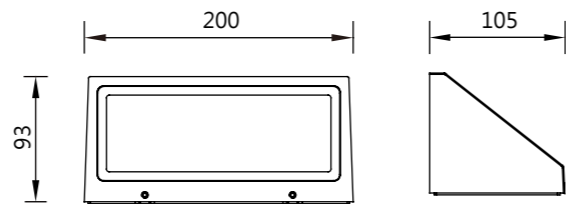
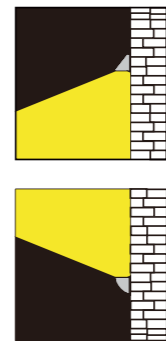

### SW3055

- LED : OSRAM 8W



IP65

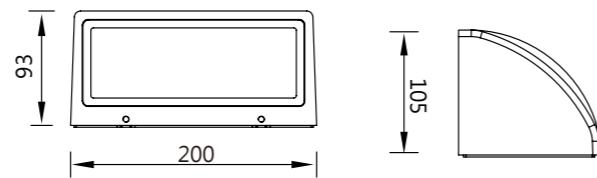
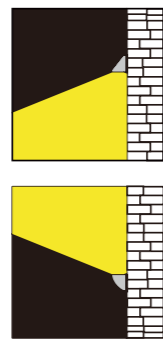

### 燈具規範

- 鋁合金壓鑄燈具本體
- 燈罩為透明強化安全玻璃

- 矽膠防水墊圈
- 220C 高溫粉體烤漆

### SW3042

- LED : CREE 4Wx2



IP65

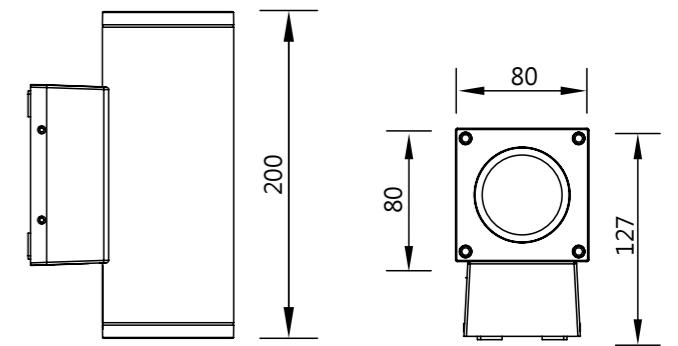
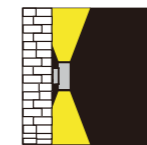

### SW803471

- LED : CREE-COB 8W



IP65

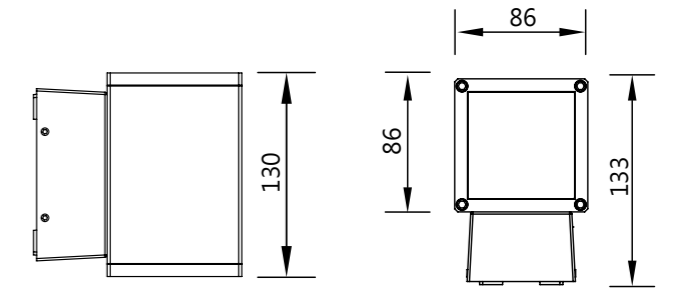
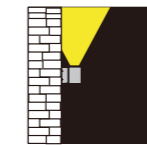

### 燈具規範

- 鋁合金壓鑄燈具本體
- 燈罩為透明強化安全玻璃

- 矽膠防水墊圈
- 220C 高溫粉體烤漆



### SG-W3029

- LED : OSRAM 10W

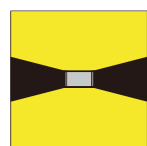

IP65

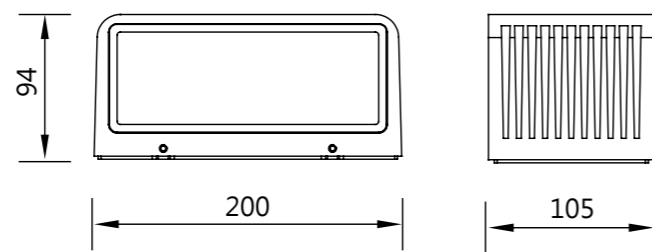

### SG-W63000S

- LED : OSRAM 10W

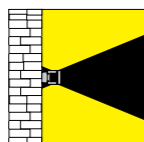

IP65

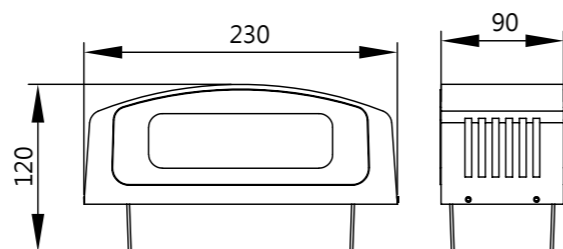

#### 燈具規範

- 鋁合金壓鑄燈具本體
- 燈罩為透明強化安全玻璃
- 矽膠防水墊圈
- 220C 高溫粉體烤漆

### SG-803072

- LED : COB 8W

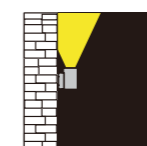

IP65

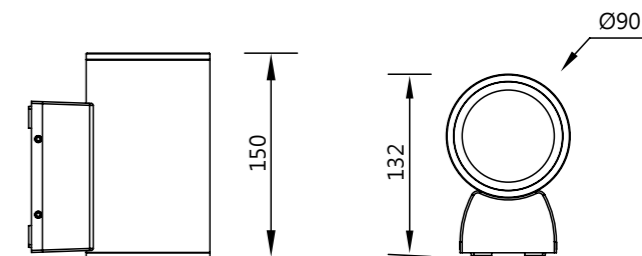

### SG-803073

- LED : COB 12W

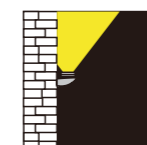

IP65

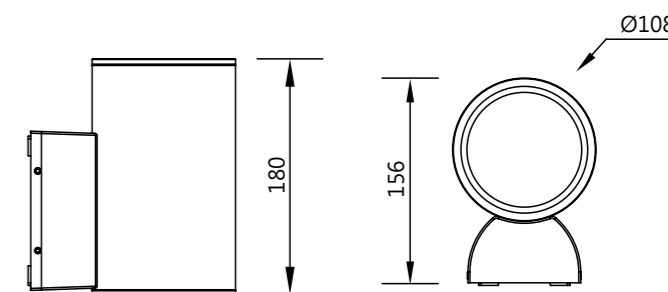

#### 燈具規範

- 鋁合金壓鑄燈具本體
- 燈罩為透明強化安全玻璃
- 矽膠防水墊圈
- 220C 高溫粉體烤漆

SG-803092  
• LED : COB 6Wx2

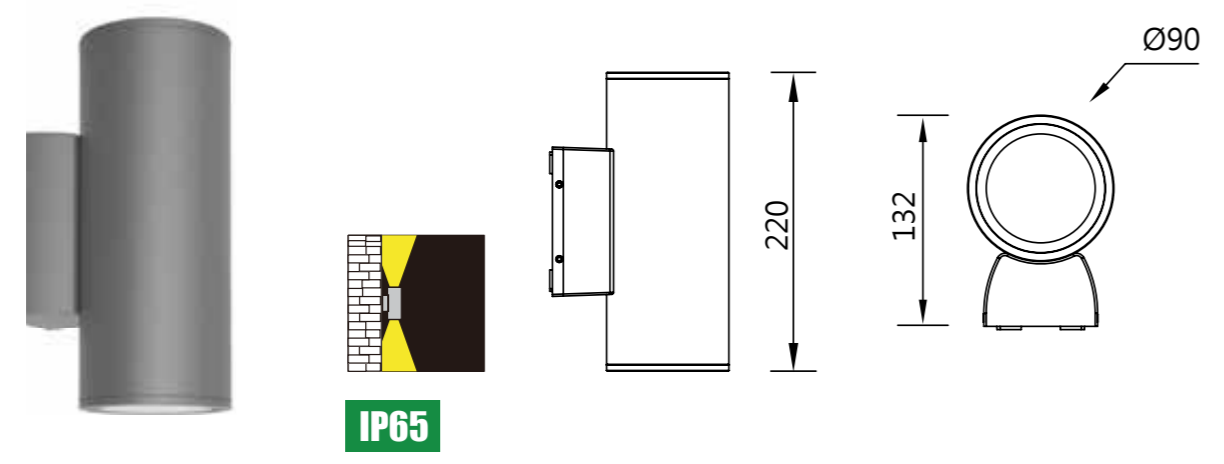

SG-803093  
• LED : COB 12Wx2

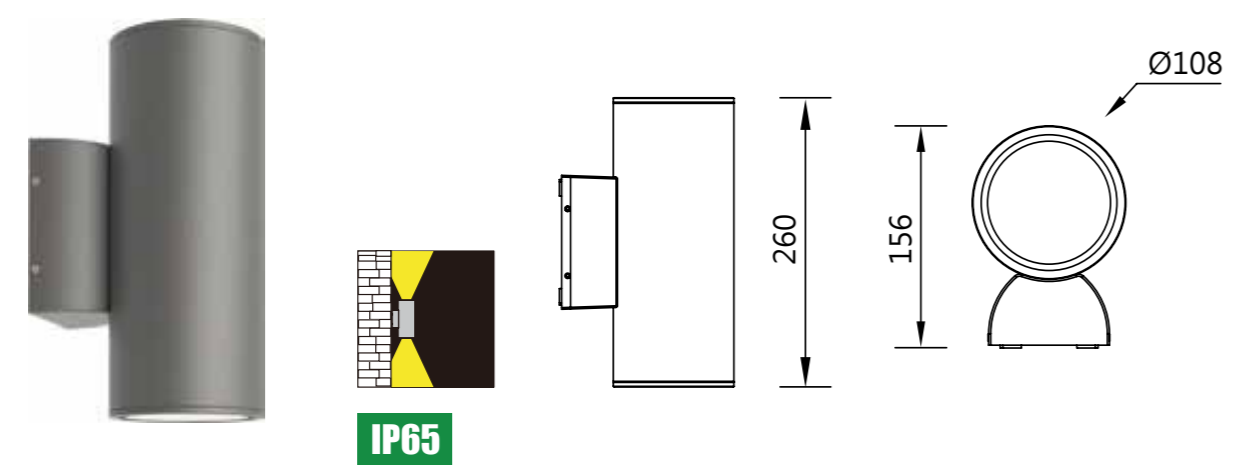

### 燈具規範

- 鋁合金壓鑄燈具本體
- 燈罩為透明強化安全玻璃
- 矽膠防水墊圈
- 220C 高溫粉體烤漆



SG-W23028  
• LED : 3Wx2

SG-W3028  
• LED : 3Wx2

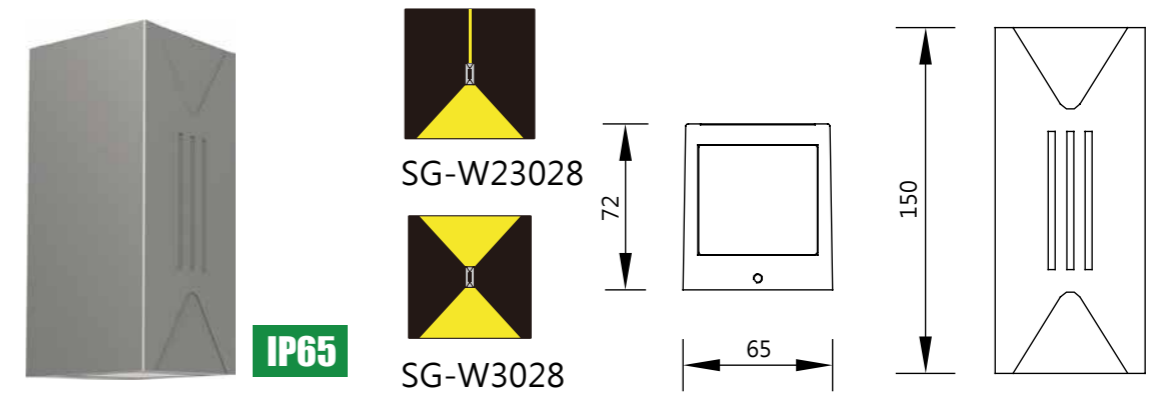

### 燈具規範

- 鋁合金壓鑄燈具本體
- 燈罩為透明強化安全玻璃
- 矽膠防水墊圈
- 220C 高溫粉體烤漆



SG-W3332

- LED : CREE 3W



IP65

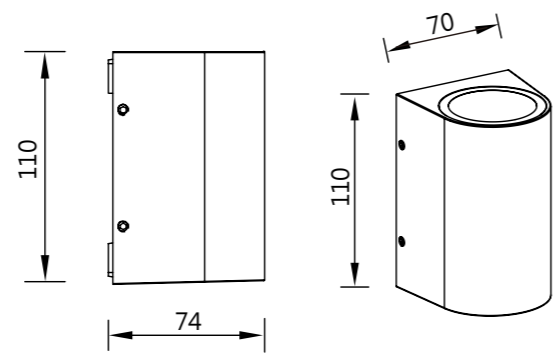

SG-W3336

- LED : OSRAM 8W



IP65

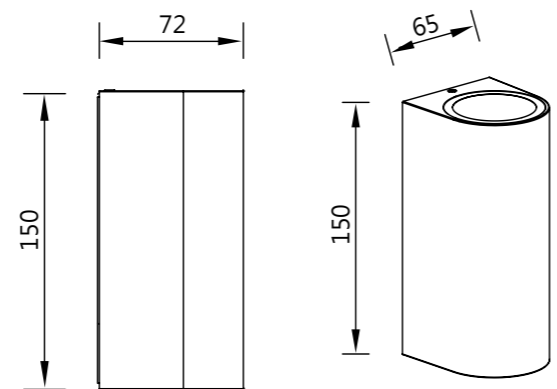

燈具規範

- 鋁合金壓鑄燈具本體
- 燈罩為透明強化安全玻璃
- 矽膠防水墊圈
- 220C 高溫粉體烤漆

SG-W3443

- LED : CREE-COB 12W

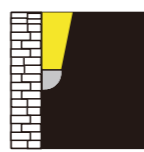

IP65

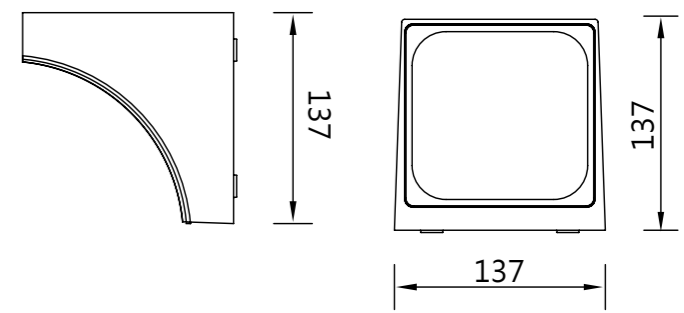

SG-W3056

- LED : CREE-COB 8W

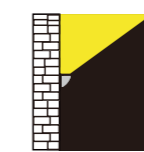

IP65

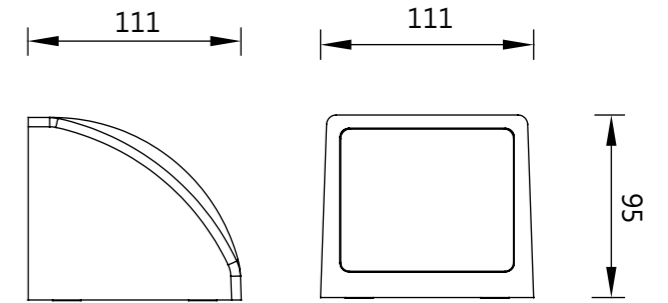

燈具規範

- 鋁合金壓鑄燈具本體
- 燈罩為透明強化安全玻璃
- 矽膠防水墊圈
- 220C 高溫粉體烤漆



### SW3033

- LED : 1Wx4

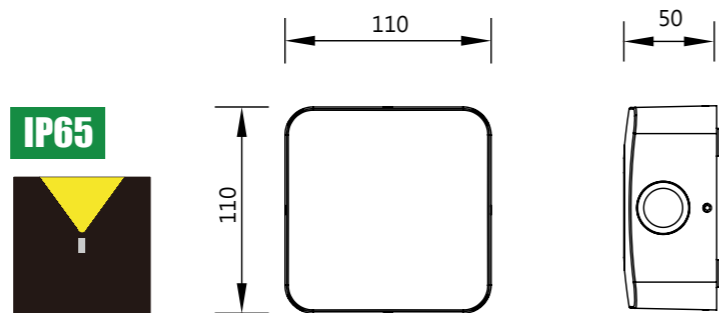

### SW3048

- LED : OSRAM 3Wx4

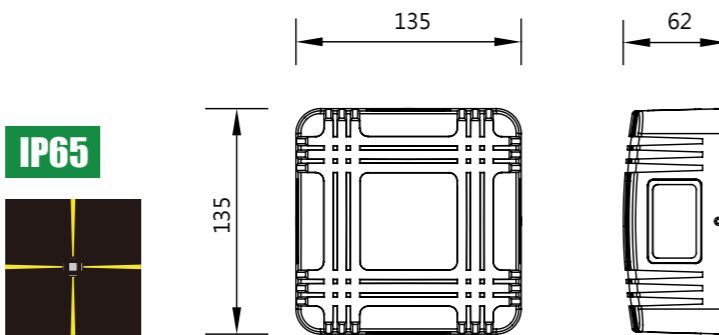

### 燈具規範

- 鋁合金壓鑄燈具本體
- 燈罩為透明強化安全玻璃

- 矽膠防水墊圈
- 220C 高溫粉體烤漆

### SW3086

- LED : OSRAM 8W



### SW3087

- LED : OSRAM 8W



### SW3088

- LED : OSRAM 8W



### 燈具規範

- 鋁合金壓鑄燈具本體
- 燈罩為乳白 PC 塑膠射出一體成型

### SW4086

- E27

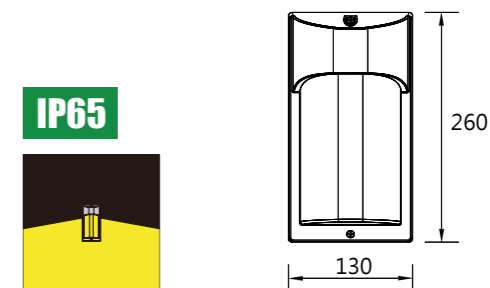

### SW4087

- E27

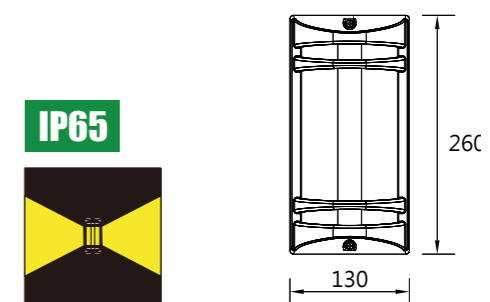

### SW4088

- E27

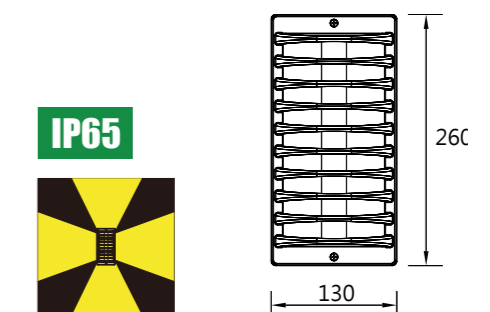

### 燈具規範

- 矽膠防水墊圈
- 220C 高溫粉體烤漆



### SC-33474

- LED : CREE-COB 6W

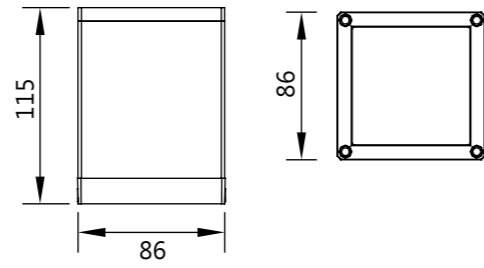

### SC-33481

- LED : CREE-COB 8W

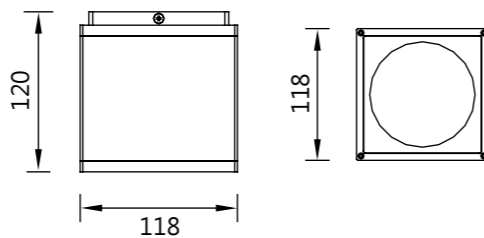

### SC-33491

- LED : CREE-COB 12W

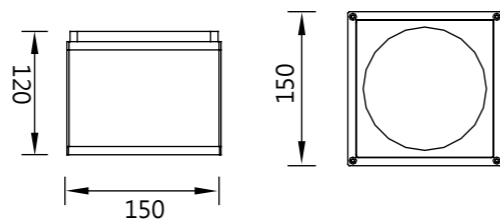

### 燈具規範

- 鋁合金壓鑄燈具本體
- 燈罩為透明強化安全玻璃

- 矽膠防水墊圈
- 220C 高溫粉體烤漆

### SC-33072

- LED : CREE-COB 6W

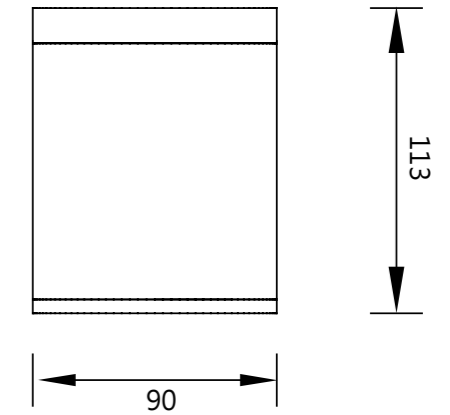

### SC-33074

- LED : CREE-COB 12W

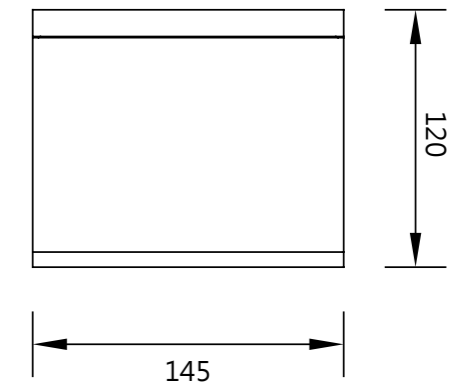

### 燈具規範

- 鋁合金壓鑄燈具本體
- 燈罩為透明強化安全玻璃
- 矽膠防水墊圈
- 220C 高溫粉體烤漆

# LED 階梯燈



## LED 階梯燈

### SL-W3508

- LED : OSRAM 5W

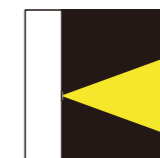

IP65

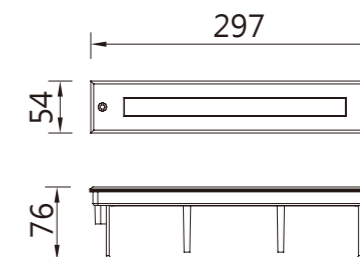

### SL-W13508

- LED : OSRAM 5W



IP65

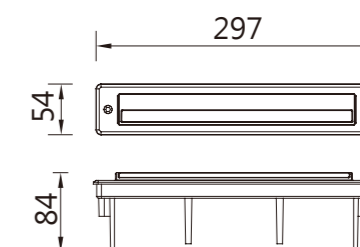

### SL-W23508

- LED : OSRAM 5W



IP65

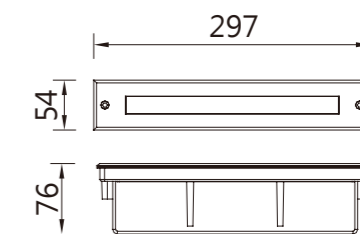

### SL-33508

- LED : OSRAM 5W

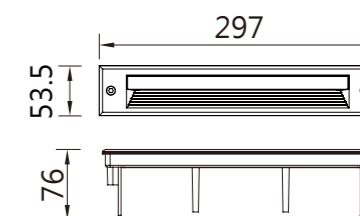
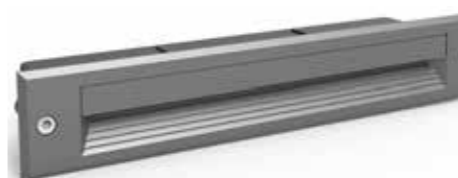

### 燈具規範

- 鋁合金壓鑄燈具本體
- 燈罩為乳白 PC+ 透明強化安全玻璃
- 矽膠防水墊圈
- 220C 高溫粉體烤漆



### SL-W3861

- LED : OSRAM 5W

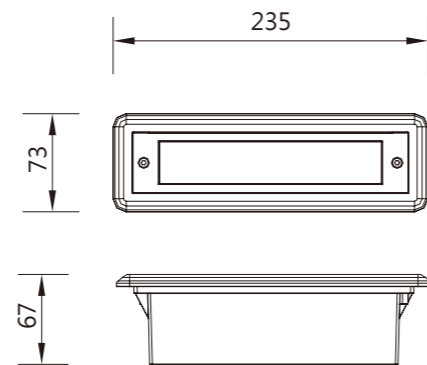

### SL-W3862

- LED : OSRAM 3W

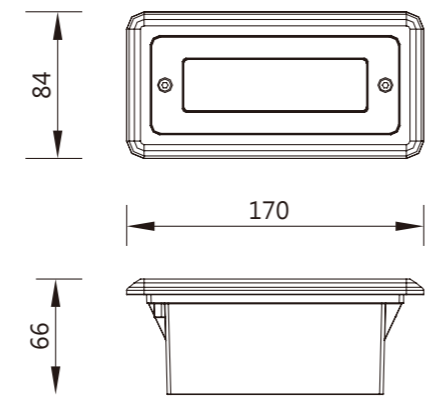

### 燈具規範

- 鋁合金壓鑄燈具本體
- 面罩不銹鋼邊框
- 燈罩為乳白 PC 塑膠射出一體成型
- 工程塑膠預埋盒
- 矽膠防水墊圈
- 220C 高溫粉體烤漆

### SG-W3582

- LED : CREE 2W

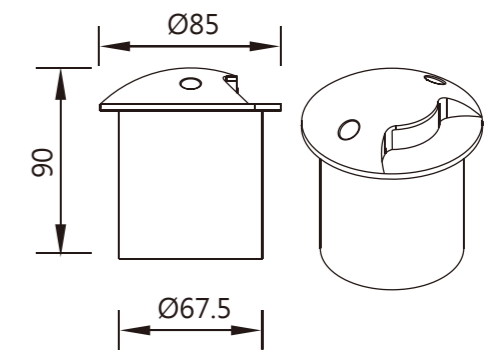
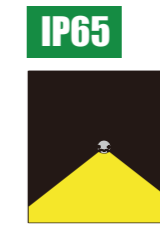
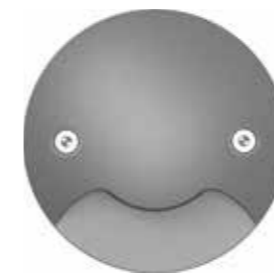

### SG-W13582

- LED : OSRAM 2W

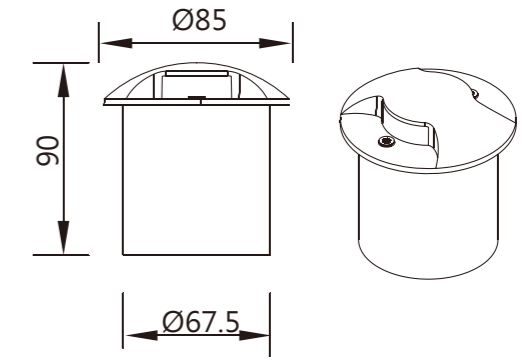
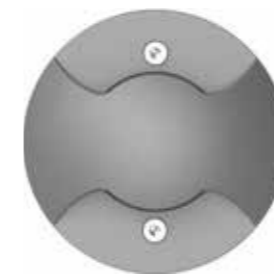

### 燈具規範

- 鋁合金壓鑄燈具本體
- 燈罩為透明 PC 塑膠射出一體成型
- 鋁擠型預埋筒
- 矽膠防水墊圈
- 220C 高溫粉體烤漆

## SG-L13863

- LED : 4W



IP65

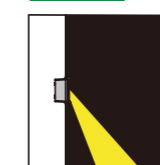

110

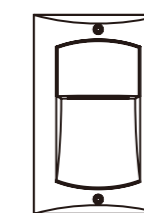

90

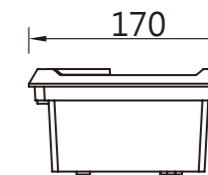

## SG-L23864

- LED : 4W



IP65



110

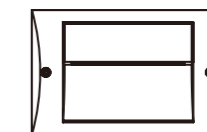

90

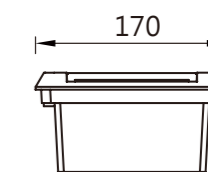

## SG-L13865

- LED : 2W



IP65

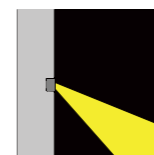

85

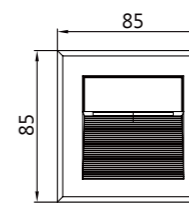

59

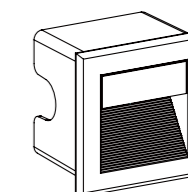
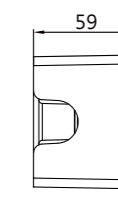

## 燈具規範

- 鋁合金壓鑄燈具本體
- 燈罩為透明強化安全玻璃
- 工程塑膠預埋盒
- 矽膠防水墊圈
- 220C 高溫粉體烤漆



# LED 地底燈

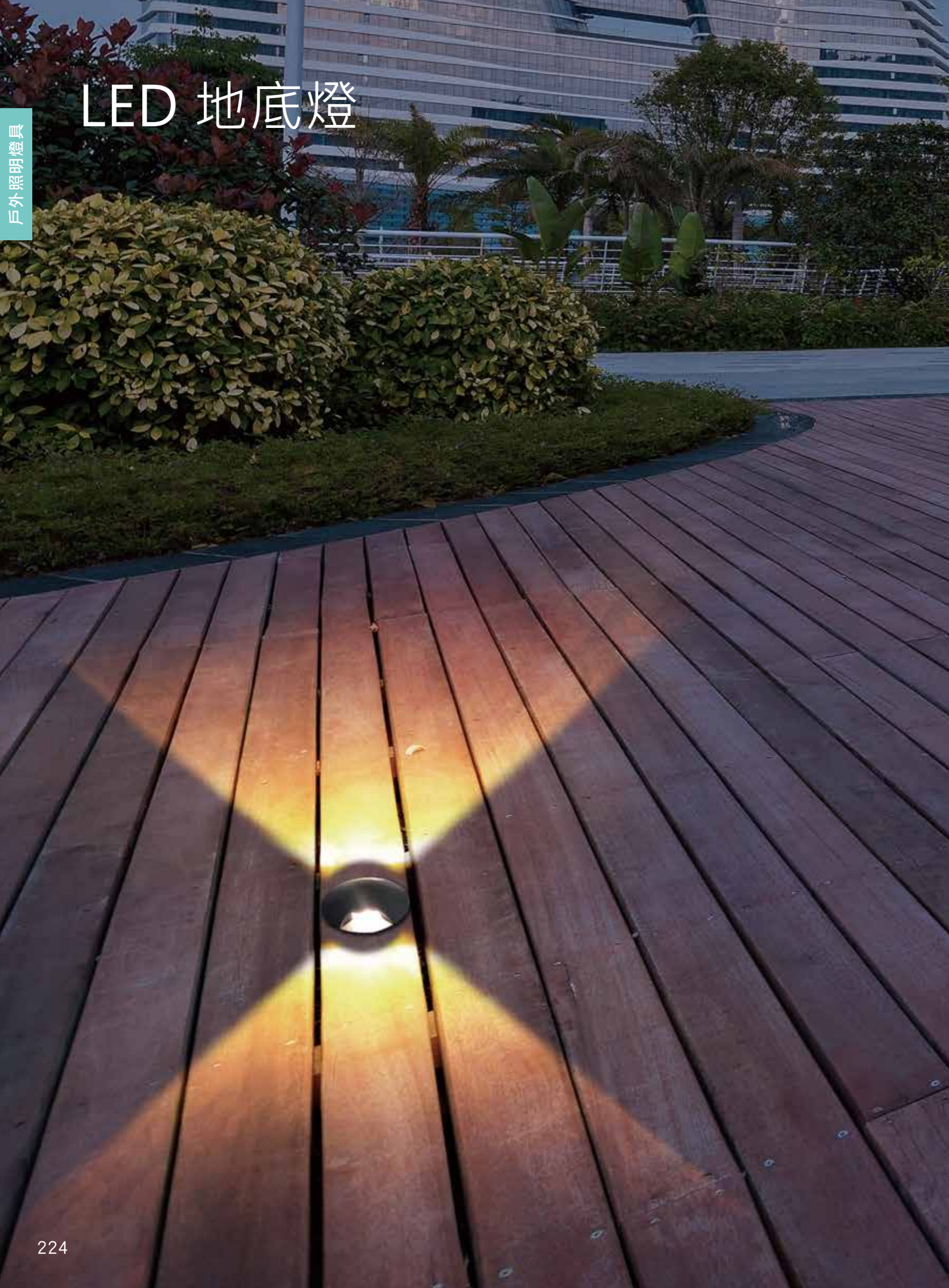

## M-013526+B

- LED : CREE 3W

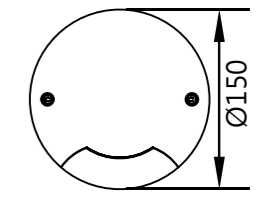
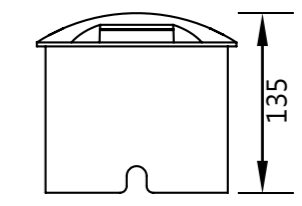

## M-023526+B

- LED : CREE 6W

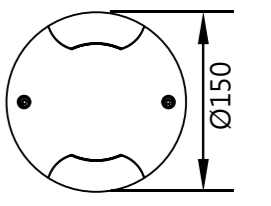
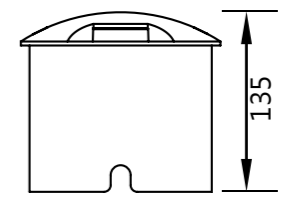

## M-003526+B

- LED : CREE 12W

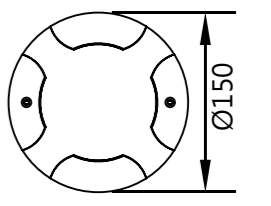
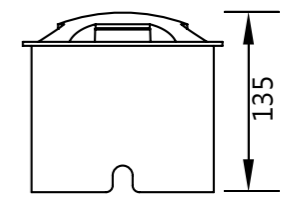

### 燈具規範

- 鋁合金壓鑄及鋁擠型燈具本體
- 燈罩為透明 PC 朔膠射出一體成型
- 鋁擠型預埋筒
- 矽膠防水墊圈
- 220C 高溫粉體烤漆



### M-023583+B

- LED : OSRAM 6W

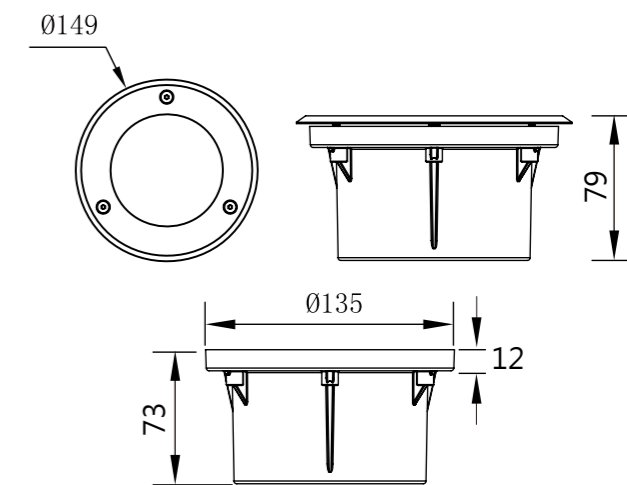

### M-043670+B

- LED : CREE 4W

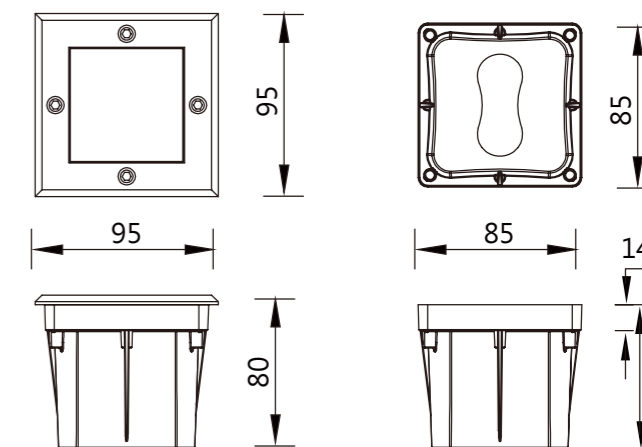

### 燈具規範

- 不銹鋼燈具面框
- 鋁合金壓鑄燈具本體
- 燈罩為透明強化安全玻璃
- 工程朔膠預埋盒
- 矽膠防水墊圈
- 220C 高溫粉體烤漆

# LED 草皮燈



## LED 草皮燈

### SG-3121

- LED : CREE-COB 8W



IP65

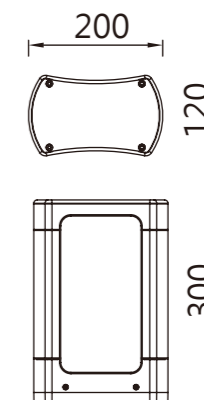

### SG-3121

- LED : CREE-COB 8W



IP65

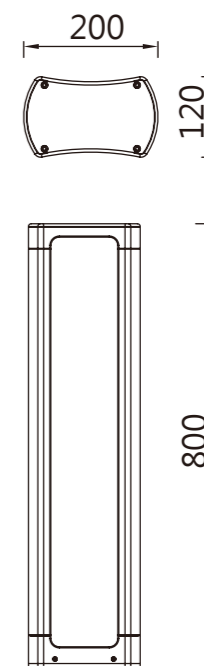
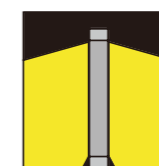

### 燈具規範

- 鋁合金壓鑄及鋁擠型燈具本體
- 燈罩為透明強化安全玻璃
- 矽膠防水墊圈
- 220C 高溫粉體烤漆



# LED 草皮燈

## P-013243-60

- LED : CREE-COB 12W



IP65

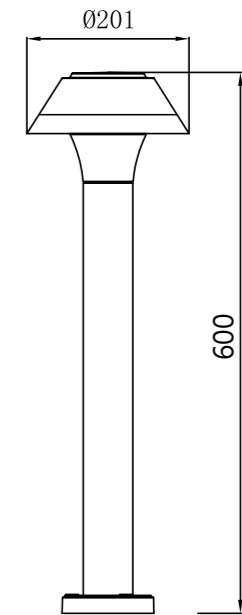
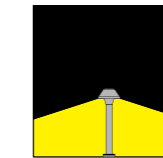

## P-003243-60

- LED : OSRAM 12W



IP65

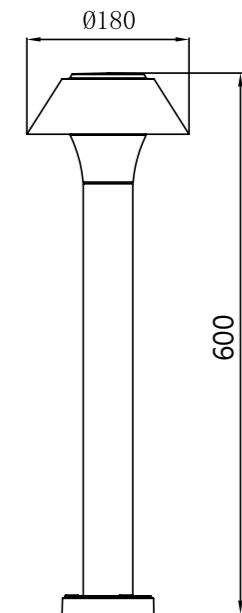
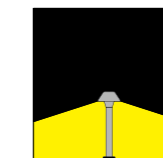

### 燈具規範

- 鋁合金壓鑄及鋁擠型燈具本體
- 燈罩為透明 PC 塑膠射出一體成型
- 矽膠防水墊圈
- 220C 高溫粉體烤漆



### P-023243-60

- LED : CREE-COB 12W

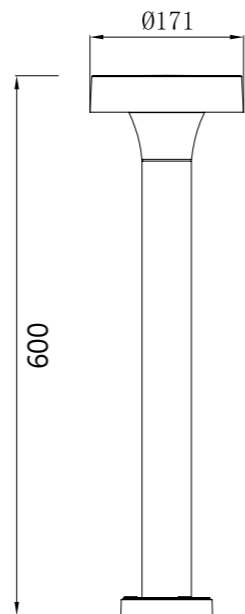
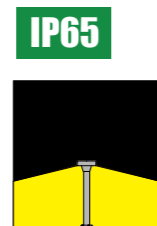

#### 燈具規範

- 鋁合金壓鑄及鋁擠型燈具本體
- 燈罩為透明 PC 塑膠射出一體成型
- 矽膠防水墊圈
- 220C 高溫粉體烤漆

### P-003103RH-60

- LED : CREE-COB 8W

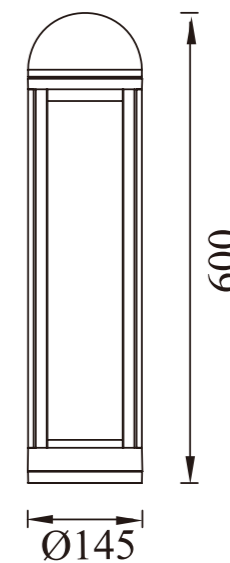
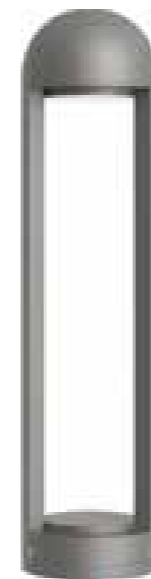

#### 燈具規範

- 鋁合金壓鑄及鋁擠型燈具本體
- 燈罩為透明強化安全玻璃
- 矽膠防水墊圈
- 220C 高溫粉體烤漆



### P-003104-80

- LED : CREE-COB 8W



IP65

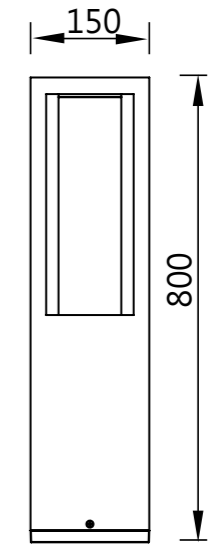

### P-003102-80

- LED : CREE-COB 8W



IP65

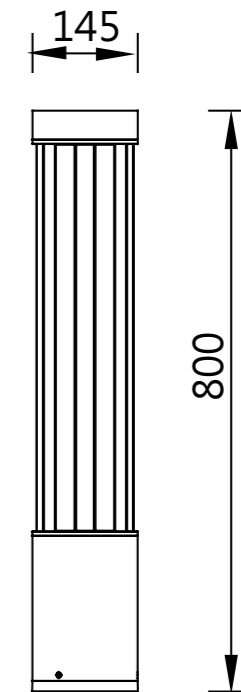
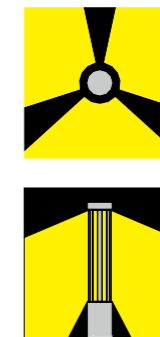

### 燈具規範

- 鋁合金壓鑄及鋁擠型燈具本體
- 燈罩為透明強化安全玻璃
- 矽膠防水墊圈
- 220C 高溫粉體烤漆



### SG-M083279-60

- LED : CREE-COB 12W



IP65

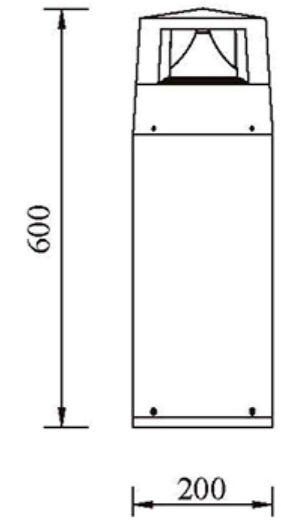

### SG-M095281D-60

- E27



IP65

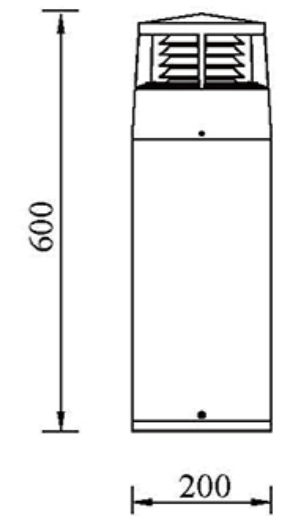

### SG-013279

- LED : CREE-COB 12W



IP65



### SG-013281

- LED : CREE-COB 12W



IP65



### SG-005281D

- E27



IP65



### 燈具規範

- 鋁合金壓鑄燈具本體
- 燈罩為透明 PC 塑膠射出一體成型
- 矽膠防水墊圈
- 220C 高溫粉體烤漆

### 燈具規範

- 鋁合金壓鑄及鋁擠型燈具本體
- 燈罩為透明 PC 塑膠射出一體成型
- 矽膠防水墊圈



### P-003240-80

- LED : OSRAM 12W



IP65

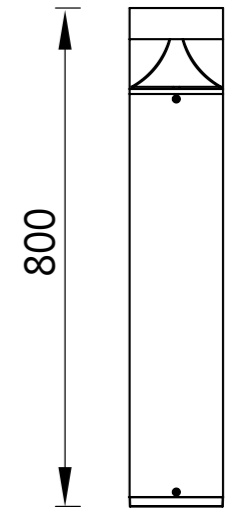
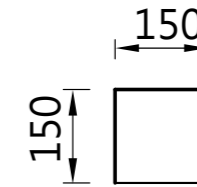
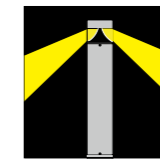

### P-013236-80

- LED : CREE-COB 8W



IP65

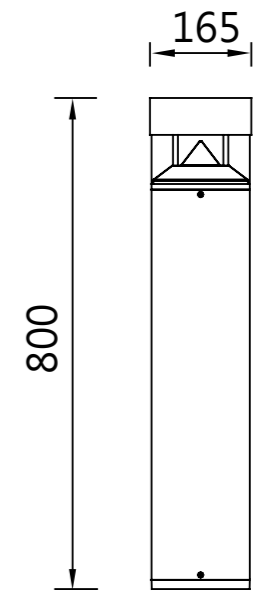
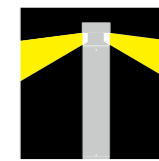

### 燈具規範

- 鋁合金壓鑄及鋁擠型燈具本體
- 燈罩為透明 PC 塑膠射出一體成型
- 矽膠防水墊圈
- 220C 高溫粉體烤漆





### SG-7226

- E27



IP65

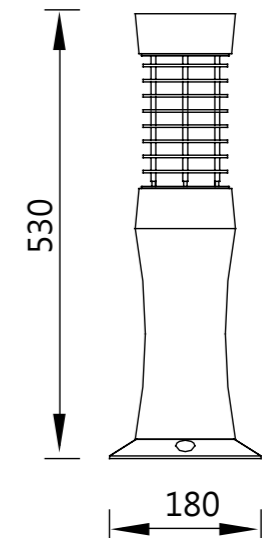
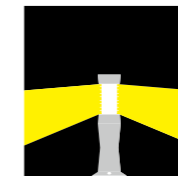

### 燈具規範

- 鋁合金壓鑄及鋁擠型燈具本體
- 燈罩為乳白 PC 塑膠射出一體成型
- 矽膠防水墊圈
- 220C 高溫粉體烤漆

### SG-3231

- LED : CREE-COB 8W



IP65

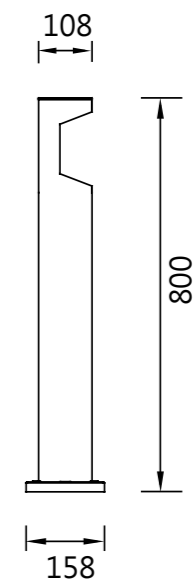
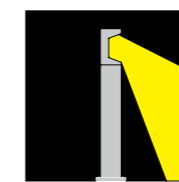
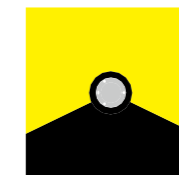

### 燈具規範

- 鋁合金壓鑄及鋁擠型燈具本體
- 燈罩為透明強化安全玻璃
- 矽膠防水墊圈
- 220C 高溫粉體烤漆



### SG5083

- LED : CREE-COB 8W

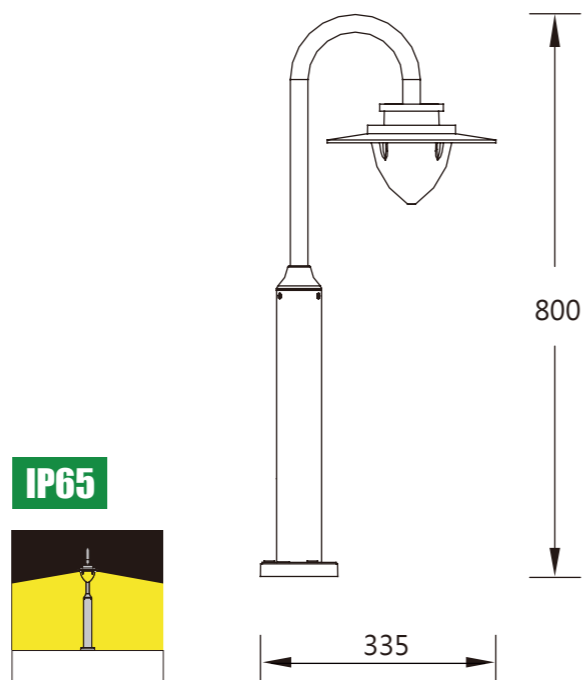

### 燈具規範

- 鋁合金壓鑄及鋁擠型燈具本體
- 矽膠防水墊圈
- 燈罩為乳白 PC 塑膠射出一體成型
- 220C 高溫粉體烤漆

### SG6081

- E27

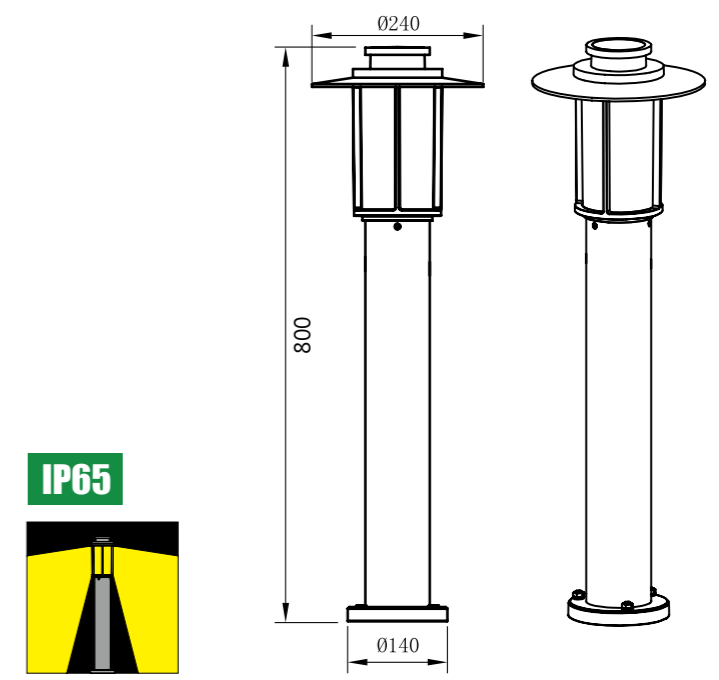

### 燈具規範

- 鋁合金壓鑄及鋁擠型燈具本體
- 矽膠防水墊圈
- 燈罩為乳白 PC 塑膠射出一體成型
- 220C 高溫粉體烤漆



### SG23231

- LED : LUMILEDS 12W

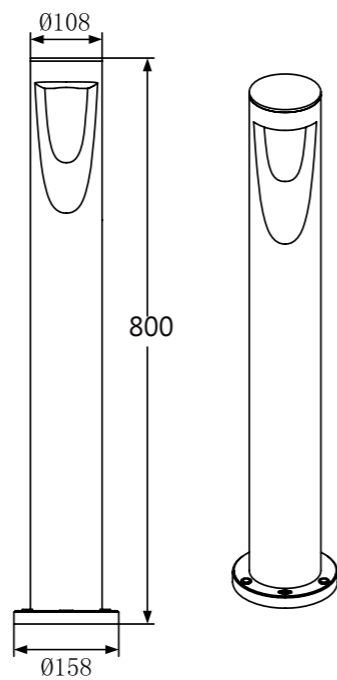

### 燈具規範

- 鋁合金壓鑄及鋁擠型燈具本體
- 燈罩為透明強化安全玻璃
- 矽膠防水墊圈
- 220C 高溫粉體烤漆

# LED 照樹燈



### SG3729

- LED : CREE-COB 12W

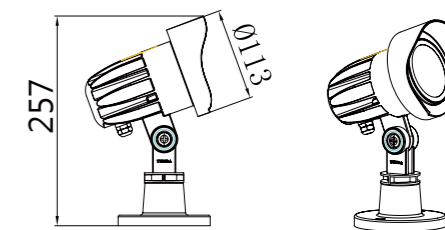

### SG3729

- LED : CREE-COB 12W

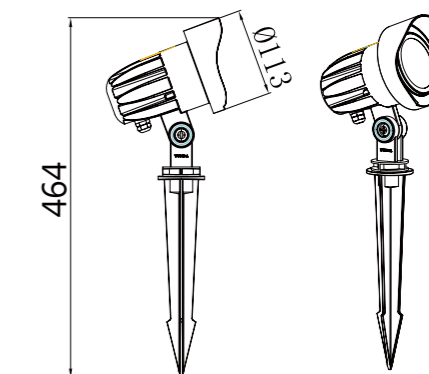
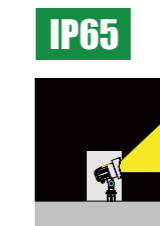

### 燈具規範

- 鋁合金壓鑄燈具本體
- 燈罩為透明強化安全玻璃
- 矽膠防水墊圈
- 220C 高溫粉體烤漆



### SG3723DZ

- LED : CREE-COB 12W

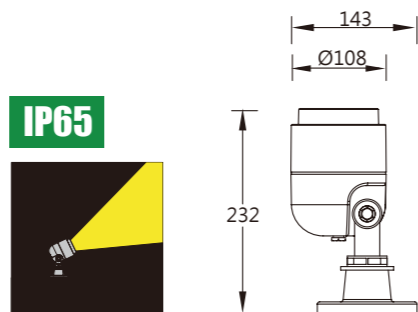

### SG3723

- LED : CREE-COB 12W

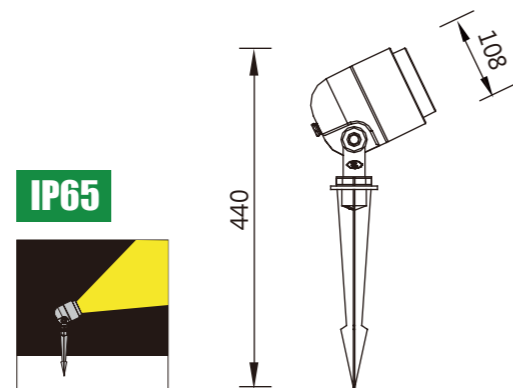

### 燈具規範

- 鋁合金壓鑄燈具本體
- 燈罩為透明強化安全玻璃

- 矽膠防水墊圈
- 220C 高溫粉體烤漆

### SG3731

- LED : OSRAM 4W



IP65

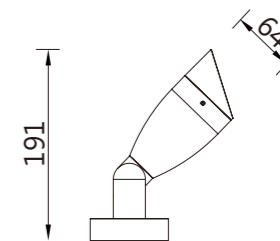
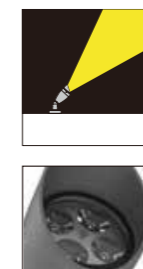

### SG3731

- LED : OSRAM 4W



IP65

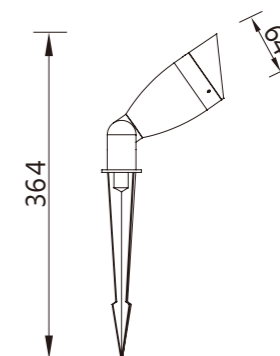
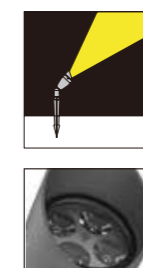

### SG43783

- LED : CREE-COB 12W



IP65

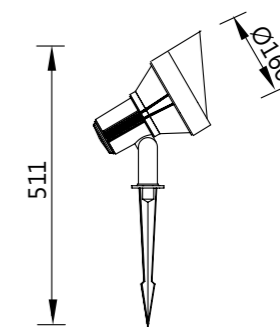
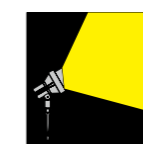

### 燈具規範

- 鋁合金壓鑄燈具本體
- 燈罩為透明強化安全玻璃

- 矽膠防水墊圈
- 220C 高溫粉體烤漆



### SG13363

- LED : 6W



IP65

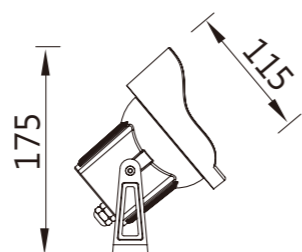

### SG13364

- LED : COB 8W



IP65

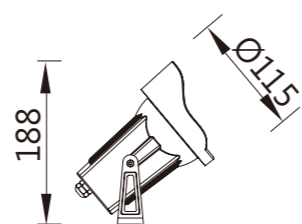

### S-M013363

- LED : OSRAM 4W



IP65

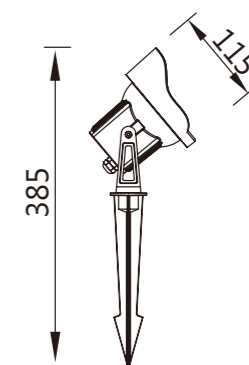

### SG13364

- LED : CREE-COB 8W



IP65

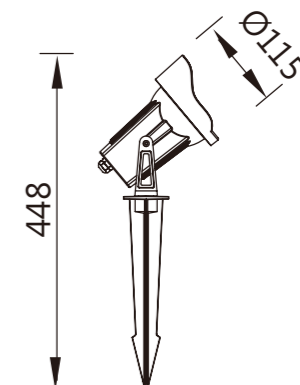

### SG03554

- LED : OSRAM 2W



IP65

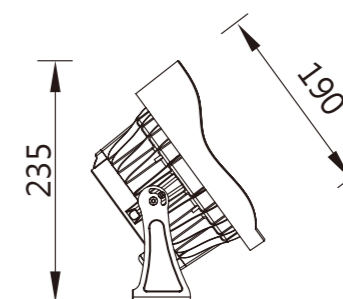

### 燈具規範

- 鋁合金壓鑄燈具本體
- 燈罩為透明強化安全玻璃
- 矽膠防水墊圈
- 220C 高溫粉體烤漆



### SG3601

- LED : 1Wx3



IP68

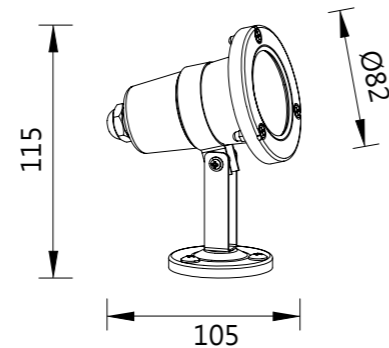
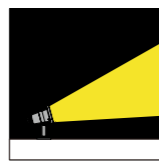

### SG3651

- LED : 1Wx3



IP68

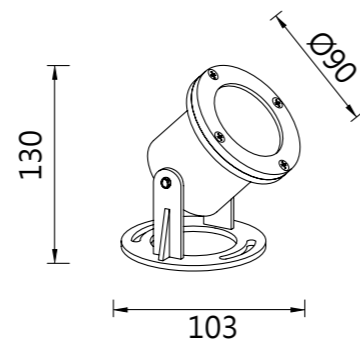
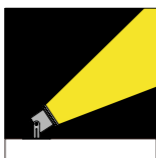

### 燈具規範

- 不銹鋼燈具本體
- 不銹鋼支架
- 燈罩為透明強化安全玻璃
- 矽膠防水墊圈
- 本產品均為低壓水池燈變壓器需外置



IP66

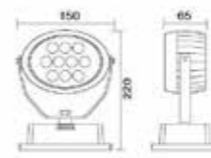

### SG-D1279

- LED : 10W / 18W

### 燈具規範

- 不銹鋼本體
- 110 / 220VAC
- 燈罩為透明強化安全玻璃



IP66

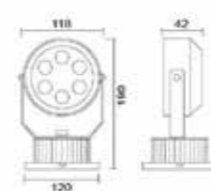

### SG-D1280

- LED : 6W

### 燈具規範

- 不銹鋼本體
- 110 / 220VAC
- 燈罩為透明強化安全玻璃



IP66

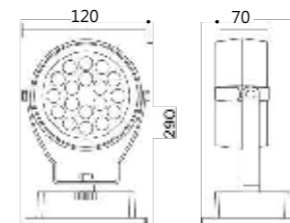

### SG-M1281

- LED : 18W

### 燈具規範

- 不銹鋼本體
- 110 / 220VAC
- 燈罩為透明強化安全玻璃





LED 草皮燈



SG-M1300

- LED : 8W

燈具規範

- 不銹鋼本體
- 110 / 220VAC
- 玻璃燈罩
- 表面耐候性烤漆
- E27 燈座

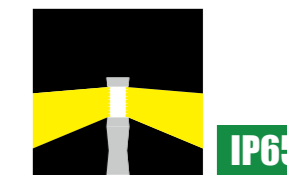

SG-M1301

- LED : 8W

燈具規範

- 不銹鋼本體
- 110 / 220VAC
- 玻璃燈罩
- 表面耐候性烤漆
- E27 燈座

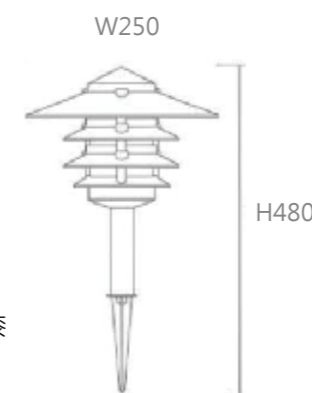

SG-M1282

- LED : 15W

燈具規範

- 不銹鋼本體
- 110 / 220VAC
- 燈罩為透明強化安全玻璃
- LED E27 PAR38

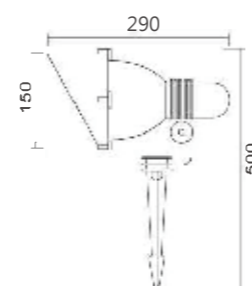

SG-M1284

- LED : 15W

燈具規範

- 不銹鋼本體
- 110 / 220VAC
- 燈罩為透明強化安全玻璃
- LED E27 PAR38

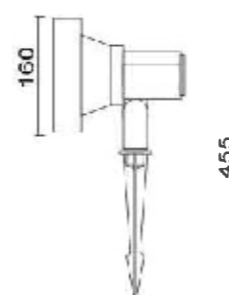



### SG-M1307

- LED : 6W

#### 燈具規範

- 筒身、面蓋：不鏽鋼
- 110/220VAC
- 玻璃強化燈罩
- 表面耐候性烤漆
- 預埋盒：工程塑膠

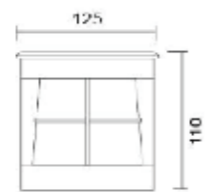

IP66

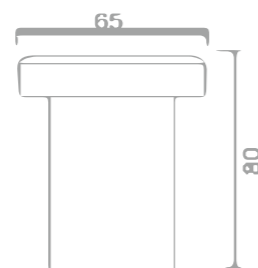

IP66

### SG-M1311

- LED : 1W

#### 燈具規範

- 不銹鋼面蓋
- DC12V
- 玻璃強化燈罩
- 表面耐候性烤漆

### SG-M1304

- LED : 1.5W 模組

#### 燈具規範

- 燈體：壓鑄鋁(封底)
- 110/220VAC
- 玻璃強化燈罩
- 表面耐候性烤漆
- 預埋盒：工程塑膠



IP66

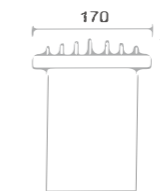

IP66

### SG-M1305

- LED : 1.5W 模組

#### 燈具規範

- 燈體：壓鑄鋁(封底)
- 110/220VAC
- 玻璃強化燈罩
- 表面耐候性烤漆
- 預埋盒：工程塑膠





